

Salt Lake City Police Department

SLCPD Policy Manual

CODE OF ETHICS

LAW ENFORCEMENT CODE OF ETHICS

All law enforcement officers must be fully aware of the ethical responsibilities of their position and must strive constantly to live up to the highest possible standards of professional policing.

The International Association of Chiefs of Police believes it is important that police officers have clear advice and counsel available to assist them in performing their duties consistent with these standards, and has adopted the following ethical mandates as guidelines to meet these ends. All officers of the Salt Lake City Police Department are required to abide by the following code of ethics. Additionally, ethics training shall be provided to all sworn officers at least once every two years.

Performance of the Duties of a Police Officer

A police officer shall perform all duties impartially, without favor or affection or ill will, and without regard to status, sex, race, religion, political belief, or aspiration. All citizens will be treated equally with courtesy, consideration, and dignity.

Officers will never allow personal feelings, animosities, or friendships to influence official conduct. Laws will be enforced appropriately and courteously and, in carrying out their responsibilities, officers will strive to obtain maximum cooperation from the public. They will conduct themselves in appearance and deportment in such a manner as to inspire confidence and respect of the position of public trust they hold.

Discretion

A police officer will use responsibly the discretion vested in the position and exercise it within the law. The principle of reasonableness will guide the officer's determinations and the officer will consider all surrounding circumstances in determining whether any legal action shall be taken.

Consistent and wise use of discretion, based on professional policing competence, will do much to preserve good relationships and retain the confidence of the public. There can be difficulty in choosing between conflicting courses of action. It is important to remember that a timely word of advice rather than arrest - which may be correct in appropriate circumstances - can be a more effective means of achieving a desired end.

Use of Force

A police officer will never employ unnecessary force or violence and will use only such force in the discharge of duty as is reasonable in all circumstances.

Force should be used only with the greatest restraint and only after discussion, negotiation and persuasion have been found to be inappropriate or ineffective. While the use of force is occasionally unavoidable, every police officer will refrain from applying the unnecessary infliction of pain or suffering and will never engage in cruel, degrading, or inhuman treatment of any person.

Confidentiality

Code of Ethics

Whatever a police officer sees, hears, or learns, which is of a confidential nature, will be kept secret unless the performance of duty or legal provision requires otherwise.

Members of the public have a right to security and privacy, and information obtained about them must not be improperly divulged.

Integrity

A police officer will not engage in acts of corruption or bribery, nor will an officer condone such acts by other police officers.

The public demands that the integrity of police officers be above reproach. Police officers must, therefore, avoid any conduct that might compromise integrity and thus undercut the public confidence in a law enforcement agency. Officers will refuse to accept any gifts, presents, subscriptions, favors, gratuities, or promises that could be interpreted as seeking to cause the officer to refrain from performing official duties.

Respect from the public cannot be bought; it can only be earned and cultivated.

Cooperation with Other Officers and Agencies

Police officers will cooperate with all legally authorized agencies and their representatives in the pursuit of justice.

An officer or agency may be one among many organizations that may provide law enforcement services to a jurisdiction. It is imperative that a police officer assist colleagues fully and completely with respect and consideration at all times.

Personal/Professional Capabilities

Police officers will be responsible for their own standard of professional performance and will take every reasonable opportunity to enhance and improve their level of knowledge and competence.

Through study and experience, a police officer can acquire the high level of knowledge and competence that is essential for the efficient and effective performance of duty. The acquisition of knowledge is a never ending process of personal and professional development that should be pursued constantly.

Private Life

Police officers will behave in a manner that does not bring discredit to their agencies or themselves.

A police officer's character and conduct while off-duty must always be exemplary, thus maintaining a position of respect in the community in which he or she lives and serves. The officer's personal behavior must be beyond reproach.

NON-SWORN PERSONNEL CODE OF ETHICS

Non-sworn members of the Salt Lake City Police Department hold high ethical responsibilities in their positions as well. Just like the police officers of the Salt Lake City Police Department, they must strive constantly to live up to the highest possible standards of their profession. As such,

Code of Ethics

all non-sworn personnel of the Salt Lake City Police Department are required to abide by the following code of ethics. Additionally, ethics training shall be provided to all non-sworn personnel at least once every two years.

Performance of Duties

Members shall perform all duties impartially, without affection or ill will, and without regard to status, sex, race, religion, political belief, or aspiration. All citizens will be treated equally with courtesy, consideration, and dignity.

Members will never act officiously or permit personal feelings, prejudices, animosities, or friendships to influence their decisions. They will conduct themselves in appearance and deportment in such a manner as to inspire confidence and respect of the position of public trust they hold.

Personal/Professional Capabilities

Members will be responsible for their own standard of professional performance and will take every reasonable opportunity to enhance and improve their level of knowledge and competence.

Through study and experience, members can acquire the high level of knowledge and competence that is essential for the efficient and effective performance of duty. The acquisition of knowledge is a never ending process of personal and professional development that should be pursued constantly.

Private Life

Members of the Salt Lake City Police Department will be honest in their personal and professional lives, and will obey the laws of the land and the regulations of the Department.

Members will not behave in a manner that brings discredit to themselves or the Department.

Confidentiality

Whatever members see or hear of a confidential nature, or that is confided in them in their official capacity, will be kept secret unless the performance of duty or legal provision requires otherwise.

Salt Lake City Police Department

SLCPD Policy Manual

STATEMENTS OF PURPOSE

SLCPD Vision Statement

The vision statement articulates the beliefs and values of the Salt Lake City Police Department and defines the ultimate goal of what all employees will work to achieve.

“We will build upon the noble traditions of integrity and trust to foster a culture of service, respect, and compassion toward our employees and the communities we serve.”

SLCPD Mission Statement

The mission of the Salt Lake City Police Department outlines the specific ways each employee will work to achieve the vision of the Department for the City, its residents, and its visitors.

“We will serve as guardians of our community to preserve life, maintain human rights, protect property, and promote individual responsibility and community commitment.”

Achieving the Goals of the Vision and Mission Statement

Upholding the vision of the Department can only be achieved by using the mission statement to guide all work and strategies while focusing on dedicated commitment and solidarity of purpose in Department activities and community involvement.

The Salt Lake City Police Department has a commitment to:

- Providing high-quality, community-oriented policing services with sensitivity.
- Protecting constitutional rights.
- Problem solving.
- Teamwork in the Department and the community.
- Long-range planning.
- Providing leadership for the police profession.
- Community policing and problem-solving principles.
- Interpersonal and communication skills.
- Bias awareness.
- Situational decision making.
- Crisis intervention, procedural justice, and impartial policing.
- Trauma and victim service.
- Analytical research and technology.
- Language and cultural responsiveness.

Leadership

The principles of leadership for the Salt Lake City Police Department are to:

Statements of Purpose

- Believe in, foster, and support teamwork.
- Be committed to the problem solving process; let facts, not emotions, drive decisions.
- When possible, seek employees' input before making key decisions.
- Believe that the best way to improve the quality of work or service is to ask and listen to employees promptly and fairly.
- Strive to develop mutual respect and trust with employees.
- Have a service orientation with a focus toward employees and citizens.
- Manage on the behavior of most employees, not on the few who cause problems.
- Deal with all employees promptly and fairly.
- Encourage creativity through risk taking while continuing to improve systems and examine processes.
- Be a facilitator and coach.
- Develop an open atmosphere that encourages both providing and accepting feedback.
- Develop agreed upon goals and plans, and achieve them with employees.

Community-Supported Policing Philosophy

Crime and public safety are community issues. Therefore, the community and the police must work together with solidarity of purpose to solve them with shared responsibility and participation. Citizens, the Police Department, other agencies, and City government are equally responsible to help reshape this mission and advance in demonstrable steps. Each entity must be willing to work together, to become involved, to take initiative, and to cooperate with each other to help make the City more enjoyable and safer for all, raising the bar over time for the community as a whole.

Community-Supported Policing is the heart of this direction and plan, and is a durable platform for sustained action. Each member of the Salt Lake City Police Department is responsible for achieving its mission, owning the outcome, and providing consideration for unique circumstances. Likewise, the community, in solidarity and shared vision, has a stake in the outcome, provides bottom-up contributions, and shares responsibility for making this City both safer and more enjoyable.

How members of the Department define their role will set the tone for the community.

Core Values of the Salt Lake City Police Department

Character - The moral qualities distinctive to an individual. Foundational pillars of character are integrity, reverence for the law, and respect for individuals.

Compassion - Caring and respect with sensitivity and empathy. Compassionate service is essential to human relationships and indispensable to the foundation of a just and peaceful community.

Statements of Purpose

Commitment to the Community - A promise to be a loyal partner with the community. Uphold our responsibility to be responsive to community needs and implement solutions that produce meaningful results.

Communication - Honest and transparent dialogue with the community. Professional representation, dignity in our speech, and truthfulness in our interactions establish trust and legitimacy. Communication creates an environment that encourages authentic conversations about hard issues that impact the community.

Courage - Guardian and protector of the community in the face of personal sacrifice. The quality of mind or spirit that enables a person to face difficulty, danger, or pain. Organizational and individual courage to do the right thing and be held to a high standard and show the strength to stand up for those we serve.

Salt Lake City Police Department
SLCPD Policy Manual

Table of Contents

Code of Ethics.	1
Statements of Purpose.	4
Chapter 1 - Law Enforcement Role and Authority.	13
100 - Law Enforcement Authority.	14
101 - Chief Executive Officer.	17
102 - Oath of Office.	18
103 - Policy Manual.	19
Chapter 2 - Organization and Administration.	25
200 - Organizational Structure and Responsibility.	26
201 - Administrative Communications.	32
202 - Emergency Management Plan.	34
203 - Staffing Levels.	36
204 - Training.	39
205 - Electronic Mail.	43
206 - Police Facilities.	45
207 - Law Enforcement Service Agreements.	50
208 - Retiree Concealed Firearms.	51
209 - Concealed Weapon License.	53
210 - Department Audits and Reports.	55
Chapter 3 - General Operations.	59
300 - Use of Force.	60
302 - Handcuffing and Restraints.	72
303 - Control Devices and Techniques.	76
304 - Conducted Energy Device.	83
305 - Officer-Involved Critical Incidents.	88
306 - Firearms.	97
307 - Vehicle Pursuits.	110
308 - Officer Response to Calls.	121
309 - Canines.	124
310 - Domestic Violence.	133
311 - Search and Seizure.	146
312 - Temporary Custody of Juveniles and Juvenile Operations.	159
313 - Adult Abuse.	168
314 - Discriminatory Harassment.	172
315 - Child Abuse.	175
316 - Missing Adult Persons.	181
317 - Missing Children and Runaways.	186
318 - Public Alerts.	193
319 - Child and Dependent Adult Safety.	198
320 - Victim and Witness Assistance.	200

Salt Lake City Police Department

SLCPD Policy Manual

321 - Hate Crimes.	204
322 - Standards of Conduct.	206
323 - Information Technology Use.	214
324 - Report Preparation.	218
325 - Media Relations.	224
326 - Subpoenas and Court Appearances.	231
327 - Outside Agency Assistance.	233
328 - Registered Offender Information.	234
329 - Major Incident Notification.	237
330 - Death Investigation.	239
331 - Identity Fraud.	243
332 - Private Persons Arrests.	244
333 - Limited English Proficiency Services.	246
334 - Communications with Persons with Disabilities.	253
335 - School Employee Mandatory Employer Notification.	261
336 - Chaplains.	262
337 - Public Safety Video Surveillance System.	268
338 - Service Animals.	270
339 - Volunteer Program.	272
340 - Off-Duty Law Enforcement Actions.	276
341 - Department Use of Social Media for Public Relations.	278
342 - Native American Graves Protection and Repatriation.	281
343 - Diversion Programs.	283
344 - Public Order Unit.	286
345 - Transgender Individuals.	290
345 - Forensic Blood Draws.	292
346 - Law Enforcement Activity in Hospitals.	294
347 - Investigative Photographing by Officers.	298
348 - Stalking.	300
Chapter 4 - Patrol Operations.	307
400 - Patrol Function.	308
401 - Bias-Based Policing.	310
402 - Line-Up Training.	312
403 - Crime and Disaster Scene Integrity.	313
404 - Ride-Along Program.	315
405 - Hazardous Material Response.	319
406 - Hostage and Barricade Incidents.	322
407 - Special Weapons and Tactics (SWAT) Team.	327
408 - Response to Bomb Calls.	333
409 - Civil Commitments.	338
410 - Citation Releases.	343
411 - Arrest or Detention of Foreign Nationals.	345
412 - Rapid Response and Deployment.	348
413 - Immigration Violations.	351
414 - Emergency Utility Service.	353
415 - Field Training Officer Program.	354

Salt Lake City Police Department

SLCPD Policy Manual

416 - Aircraft Accidents.	356
417 - Obtaining Air Support.	360
418 - Detentions and Photographing Detainees.	361
419 - Criminal Intelligence.	365
420 - Watch Commanders.	370
421 - Mobile Data Terminal Use.	372
422 - Portable Audio/Video Recorders.	374
423 - Public Recording of Law Enforcement Activity.	379
424 - Bicycle Patrol Unit.	382
425 - Foot Pursuits.	385
426 - Automated License Plate Readers (ALPRs).	388
427 - Homeless Persons.	392
428 - First Amendment Assemblies.	394
429 - Suspicious Activity Reporting.	400
430 - Civil Disputes.	402
431 - Crisis Intervention Incidents.	406
432 - Medical Aid and Response.	411
Chapter 5 - Traffic Operations.	415
500 - Traffic Function and Responsibility.	416
501 - Traffic Collision Reporting.	421
502 - Hit and Run Collisions.	430
503 - Vehicle Towing and Release.	432
504 - Impaired Driving.	436
505 - Traffic Citations.	441
506 - Disabled Vehicles.	444
507 - Abandoned and Junk Vehicles.	445
Chapter 6 - Investigation Operations.	446
600 - Investigation and Prosecution.	447
601 - Interrogation and Confessions.	450
602 - Sexual Assault Investigations.	454
603 - Asset Forfeiture.	461
604 - Informants.	467
605 - Eyewitness Identification.	471
606 - Brady Material Disclosure.	474
607 - Pawn Shop Holds.	476
608 - Warrant Service.	478
609 - Operations Planning and Deconfliction.	484
610 - Unmanned Aircraft System (UAS) Operations.	490
611 - Undercover Operations.	495
612 - Investigative Use of Social Media and Internet Sources.	497
613 - Truth Verification Instruments.	499
Chapter 7 - Equipment.	505
700 - Department-Owned and Personal Property.	506
701 - Personal Communication Devices.	510

Salt Lake City Police Department

SLCPD Policy Manual

702 - Vehicle Maintenance.	513
703 - Vehicle Use.	516
704 - Cash Handling, Security and Management.	521
705 - Personal Protective Equipment.	523
706 - Authorized Personal Use of Public Property.	527
Chapter 8 - Support Services.	530
800 - Crime Analysis.	531
801 - Dispatch.	533
802 - Property and Evidence Chain of Custody.	539
803 - Property and Evidence Management.	541
804 - Digital Evidence.	553
805 - Records.	554
806 - Records Maintenance and Release.	557
807 - Protected Information.	561
Chapter 9 - Custody.	565
900 - Temporary Custody.	566
901 - Custodial Searches.	570
Chapter 10 - Personnel.	574
1000 - Recruitment and Selection.	575
1001 - Evaluation of Employees.	582
1002 - Promotion, Transfer, and Reassignment.	584
1003 - Complaints Against Personnel - Internal Investigations.	589
1004 - Grievances.	603
1005 - Reporting of Employee Convictions, Charges, Investigations, and Citations.	604
1006 - Drug- and Alcohol-Free Workplace.	606
1007 - Smoking and Tobacco Use.	610
1008 - Leave Time.	611
1009 - Seat Belts.	613
1010 - Body Armor.	615
1011 - Personnel Records.	617
1012 - Commendations and Awards.	620
1014 - Meal Periods and Breaks.	623
1015 - Lactation Breaks.	624
1017 - Overtime Compensation Requests.	626
1018 - Communicable Diseases.	628
1019 - Occupational Disease and Work-Related Injury Reporting.	633
1020 - Personal Appearance Standards.	635
1021 - Uniform Regulations.	639
1022 - Police Explorers.	650
1023 - Nepotism and Conflicting Relationships.	652
1024 - Department Badges.	655
1025 - Temporary Modified- and Transitional-Duty Assignments and Leaves of Absence	657
1026 - Early Identification and Intervention Program.	660
1027 - Employee Speech, Expression and Social Networking.	663

Salt Lake City Police Department

SLCPD Policy Manual

1028 - Line-of-Duty Deaths.	667
1029 - Employee Wellness and Support Program.	678
1030 - Secondary and Outside Employment.	684
1031 - Performance Improvement Plans.	697
1032 - Peer Support Program.	701
1033 - Military Leave and Reintegration.	708
Chapter 11 - Airport Operations.	710
1100 - Officer Response to Screening Refusals.	711
1101 - Firearms/Dangerous Weapons in Secure and Unsecured Areas.	713
1102 - Police Escorts.	714
1103 - Explosives Detection Canine Team Program.	716
1104 - Airport Employee Security Violations and Procedural Incidents.	725
1105 - Vehicle Escort Inspections.	728
1106 - Airport Operations Area (AOA) Safety Violations.	729
1107 - Title 16.60 Civil Code Violations.	731
1108 - Airport Closed Circuit Video Camera System.	732
1109 - Aircraft Accidents within the Airport Operation Area (AOA).	733
1110 - Airport Operations Area (AOA) Vehicle Collisions (Including with Aircraft).	737
1111 - Aircraft Laser Incidents.	740
1112 - Unmanned Aircraft (UA) Incidents.	742
Attachments.	744
SLCPD Org Chart 11.9.18.pdf.	745
SLCPD Consent to Search Form.pdf.	746
SLCPD Consent to Search Form - Fillable.pdf.	747
SIGNIFICANT EXPOSURE FLOW CHART FOR SUPERVISORS.pdf.	748
Significant Exposure Flow Chart.pdf.	749
Consent to Release Video Form - Internal.pdf.	750
Salt Lake City Police Department Organizational Chart v2.15 2020-08-17.pdf.	751
SLCPD Consent to Search Form - Fillable.pdf.	752
Mothers Room Key Form.pdf.	753
Accident Flow Chart Involving Department Employees.pdf.	754
SLCPD Mothers Room Key Form.pdf.	755
Military Extended Leave Form.pdf.	756
Military Extended Leave Reintegration Form.pdf.	757
Investigative Photography by Officers.pdf.	758
Salt Lake City Corporation Disclosure Statement of Non-City Employment Business Interests.pdf.	759
Health Records Authorization.pdf.	760
SLCPD Jurisdictional Map.pdf.	761
Use of Force Model.pdf.	762
Form 350.pdf.	763
Crash Diagram For Patrol.pdf.	764
Blood Draw Consent Form.pdf.	765
Firearms Safe Harbor Declaration.pdf.	766
Accident Flow Chart.pdf.	767

Salt Lake City Police Department

SLCPD Policy Manual

Property Release Form.pdf.	768
Domestic Violence Flow Chart.pdf.	769

Chapter 1 - Law Enforcement Role and Authority

Law Enforcement Authority

100.1 PURPOSE AND SCOPE

The purpose of this policy is to affirm the authority of the members of the Salt Lake City Police Department to perform their functions based on established legal authority.

100.2 POLICY

It is the policy of the Salt Lake City Police Department to limit its members to only exercise the authority granted to them by law.

While this department recognizes the power of peace officers to make arrests and take other enforcement action, officers are encouraged to use sound discretion in the enforcement of the law. This department does not tolerate abuse of law enforcement authority.

100.2.1 PROHIBITION OF QUOTAS

The Salt Lake City Police Department shall not establish any minimum requirement or minimum standard regarding the number or percentage of citations or arrests made by its members. This does not prohibit the Department from including a member's engagement with the community or enforcement activity as part of an overall determination of the member's performance (Utah Code 77-7-27).

100.3 PEACE OFFICER POWERS

Sworn members of the Department shall be considered peace officers pursuant to Utah Code 53-13-102 and Utah Code 53-13-103.

100.3.1 POLICE SERVICES REQUIRED - AUTHORITY

Utah law requires a city of the first class (a municipality with a population of 100,000 or more) to provide police services within its jurisdiction (Utah Code 10-3-909). Salt Lake City maintains a police department to accomplish this requirement.

Sworn officers of the Salt Lake City Police Department have authority, at all times, within the Department's jurisdiction, to preserve the public peace, prevent crime, detect and arrest offenders, suppress riots, protect persons and property, remove nuisances existing in the public streets, roads, and highways, and enforce every law relating to the suppression of offenses, and perform all duties required by ordinance or resolution (Utah Code 10-3-914).

100.3.2 ARREST AUTHORITY WITHIN THE JURISDICTION OF THE SALT LAKE CITY POLICE DEPARTMENT

The arrest authority within the jurisdiction of the Salt Lake City Police Department includes:

- (a) In compliance with an arrest warrant.
- (b) Without a warrant (Utah Code 77-7-2):
 1. For a public offense committed or attempted in the presence of an officer.

Salt Lake City Police Department

SLCPD Policy Manual

SLCPD Policy Manual

Law Enforcement Authority

2. When an officer has reasonable cause to believe that a felony or class A misdemeanor has been committed.
 3. When an officer has reasonable cause to believe that a public offense has been committed and the person to be arrested may flee or conceal him/herself to avoid arrest, destroy or conceal evidence or injure another person or damage property.
- (c) Without a warrant when there is reasonable cause to believe that the person has committed theft (Utah Code 77-7-13).
- (d) Without a warrant when an officer has probable cause to believe that a person is driving under the influence in violation of Utah Code 41-6a-502 (Utah Code 41-6a-508).

100.3.3 ARREST AUTHORITY OUTSIDE THE JURISDICTION OF THE SALT LAKE CITY POLICE DEPARTMENT

The arrest authority of officers outside the jurisdiction of the Salt Lake City Police Department includes (Utah Code 77-9-3):

- (a) When the officer is in fresh pursuit of an offender for the purpose of arresting and holding the person in custody or returning the person to the jurisdiction where the offense occurred.
- (b) When a public offense has been committed in the presence of the officer.
- (c) When the officer is participating in an investigation of criminal activity which originated in the jurisdiction of the Salt Lake City Police Department in cooperation with the local law enforcement authority.
- (d) When the officer is called to assist officers in another jurisdiction.

Officers should, when practicable, notify the local law enforcement authority prior to taking enforcement action.

100.3.4 ARREST REVIEWS

Before any booking of an arrested person into jail or any official detention facility, a documented arrest review shall occur by the arresting officer. If, at any time during an arrest, force is used on a subject, a sergeant or other sworn supervisor will be called to the scene to review the arrest. This policy does not preclude a supervisor from responding to other calls or reviewing arrests in cases not involving force.

[Salt Lake City Police Department Procedure Manual: 101.2.1 ARREST REVIEWS - SUPERVISOR RESPONSIBILITIES](#)

100.3.5 SALT LAKE CITY JURISDICTIONAL MAP

[See attachment: SLCPD Jurisdictional Map.pdf](#)

100.4 INTERSTATE PEACE OFFICER POWERS

Peace officer powers may be extended to other states:

Salt Lake City Police Department

SLCPD Policy Manual

SLCPD Policy Manual

Law Enforcement Authority

- (a) As applicable under interstate compacts, memorandums of understanding or mutual aid agreements in compliance with the laws of each state.
- (b) When an officer enters another state in fresh pursuit:
 - 1. In Colorado, to arrest the person for a crime committed in Utah (CRS § 16-3-104).
 - 2. In Arizona, Idaho, Nevada and New Mexico, to arrest the person for committing a felony in Utah (ARS § 13-3832; Idaho Code 19-701; NRS 171.158; NMSA § 31-2-1).
- (c) When an interstate compact exists with the state of Wyoming that permits an officer to pursue and arrest an offender who has fled Utah (Wyo. Stat. § 7-3-103).

Whenever an officer makes an arrest in another state, the officer shall take the offender to a magistrate or other proper judicial official in the county where the arrest occurred as soon as practicable (ARS § 13-3833; CRS § 16-3-104; Idaho Code 19-702; NRS 171.158; NMSA § 31-2-2 (New Mexico)).

100.4.1 AUTHORITY OF PEACE OFFICERS OF ANOTHER STATE

A peace officer of another state or the District of Columbia who enters this state in fresh pursuit and continues in fresh pursuit of a person in order to arrest them on the grounds that he/she is reasonably believed to have committed a felony in another state, has the same authority to arrest and hold a person in custody as a peace officer of this state. Fresh pursuit does not require instant action, but pursuit without unreasonable delay (Utah Code 77-9-1).

An officer of another state making an arrest pursuant to UCA § 77-9-1 shall without unnecessary delay take the person arrested before a magistrate of the county in which the arrest was made (Utah Code 77-9-2).

100.5 CONSTITUTIONAL REQUIREMENTS

All members shall observe and comply with every person's clearly established rights under the United States and Utah Constitutions.

100.6 REVISIONS

Enacted: January 29, 2018

Revised: September, 7 2018

Revised: November 21, 2019

Chief Executive Officer

101.1 PURPOSE AND SCOPE

Utah Code 53-6-205 mandates that all sworn officers employed after January 1, 1985 successfully complete a Utah POST Council certified academy or successfully pass a state certification examination pursuant to Utah Code 53-6-206, and obtain POST certification, prior to being permitted to exercise peace officer powers.

Salt Lake City Ordinance 2.05.030(12) mandates that the Chief of Police be a sworn peace officer with demonstrated experience or expertise in police operations, or a related field.

101.1.1 CHIEF OF POLICE REQUIREMENTS

It is recommended that a candidate for Chief of Police of the Department should, as a condition of continued employment:

- (a) Be an individual of recognized executive and administrative capacity.
- (b) Be selected solely with regard to their qualifications and fitness to discharge the duties of the office.
- (c) Be of high moral character.
- (d) Be of good standing in their community of residence.

101.2 CHIEF OF POLICE AUTHORITY AND RESPONSIBILITY

Salt Lake City Ordinance 2.08.090(B) grants the Chief of Police appointing power and command over all officers, members, and employees in the Department. The Chief of Police has the authority and responsibility to make and adopt such rules and regulations for the operation and administration of the Department, as, in the Chief's judgment, are necessary for the good of the Department's service to the City.

101.3 REVISIONS

Enacted: January 29, 2018

Oath of Office

102.1 PURPOSE AND SCOPE

Officers of the Department are sworn to uphold the federal and state constitutions and to enforce federal, state and local laws.

102.2 POLICY

It is the policy of the Salt Lake City Police Department that, when appropriate, department members affirm the oath of their office as an expression of commitment to the constitutional rights of those served by the Department and the dedication of its members to their duties.

102.3 OATH OF OFFICE

All department members, when appropriate, shall take and subscribe to the oaths or affirmations applicable to their positions (Utah Constitution Article IV § 10).

If a member is opposed to taking an oath, he/she shall be permitted to substitute the word "affirm" for the word "swear."

102.3.1 SWORN PERSONNEL OATH OF OFFICE

"I do solemnly affirm that I will support, obey, and defend the Constitution of the United States, and the Constitution of this State, and that I will discharge the duties of my office with fidelity."

102.4 MAINTENANCE OF RECORDS

The oath of office shall be filed as prescribed by law (Utah Code 52-1-2 et seq.).

102.5 REVISIONS

Enacted: January 29, 2018

Policy Manual

103.1 PURPOSE AND SCOPE

The manual of the Salt Lake City Police Department is hereby established and shall be referred to as the Policy Manual or the manual. The manual is a statement of the current policies, rules and guidelines of this department. All members are to conform to the provisions of this manual.

All prior and existing manuals, orders and regulations that are in conflict with this manual are rescinded, except to the extent that portions of existing manuals, procedures, orders and other regulations that have not been included herein shall remain in effect, provided that they do not conflict with the provisions of this manual.

103.2 POLICY

Except where otherwise expressly stated, the provisions of this manual shall be considered as guidelines. It is recognized that the work of law enforcement is not always predictable and circumstances may arise which warrant departure from these guidelines. It is the intent of this manual to be viewed from an objective standard, taking into consideration the sound discretion entrusted to members of this department under the circumstances reasonably available at the time of any incident.

103.2.1 DISCLAIMER

The provisions contained in the Policy Manual are not intended to create an employment contract nor any employment rights or entitlements. The policies contained within this manual are for the internal use of the Salt Lake City Police Department and shall not be construed to create a higher standard or duty of care for civil or criminal liability against the City, its officials or members. Violations of any provision of any policy contained within this manual shall only form the basis for department administrative action, training or discipline. The Salt Lake City Police Department reserves the right to revise any policy content, in whole or in part.

103.3 AUTHORITY

The Chief of Police shall be considered the ultimate authority for the content and adoption of the provisions of this manual and shall ensure compliance with all applicable federal, state and local laws. The Chief of Police or the authorized designee is authorized to issue Departmental Directives (i.e., Chief's Orders and Chief's Memorandums), which shall modify those provisions of the manual to which they pertain. Departmental Directives shall remain in effect until such time as they may be permanently incorporated into the manual.

103.4 DEFINITIONS

The following words and terms shall have these assigned meanings throughout the Policy Manual, unless it is apparent from the content that they have a different meaning:

Adult - Any person 18 years of age or older.

CFR - Code of Federal Regulations.

Salt Lake City Police Department

SLCPD Policy Manual

SLCPD Policy Manual

Policy Manual

City - The City of Salt Lake City.

Non-sworn - Employees and volunteers who are not sworn peace officers.

Department/SLCPD - The Salt Lake City Police Department.

DMV - The Department of Motor Vehicles.

Employee/personnel - Any person employed by the Department.

Juvenile - Any person under the age of 18-years.

Manual - The Salt Lake City Police Department Policy Manual.

May - Indicates a permissive, discretionary or conditional action.

Member - Any person employed or appointed by the Salt Lake City Police Department, including:

- Full- and part-time employees
- Sworn peace officers
- Reserve, auxiliary officers
- Non-sworn employees
- Volunteers

MOU - The manual often refers to a Memorandum of Understanding (MOU). In the manual, this term refers to the MOU the City has with a labor organization being referenced within a given policy.

Officer - Those employees, regardless of rank, who are sworn peace officer employees of the Salt Lake City Police Department.

On-duty - A member's status during the period when he/she is actually engaged in the performance of his/her assigned duties.

Order - A written or verbal instruction issued by a superior.

POST - The Utah Peace Officer Standards and Training Division.

Rank - The title of the classification held by an officer.

Shall or will - Indicates a mandatory action.

Should- Indicates a generally required or expected action, absent a rational basis for failing to conform.

Supervisor - A person in a position of authority that may include responsibility for hiring, transfer, suspension, promotion, discharge, assignment, reward or discipline of other department members, directing the work of other members or having the authority to adjust grievances. The supervisory exercise of authority may not be merely routine or clerical in nature but requires the use of independent judgment.

Salt Lake City Police Department

SLCPD Policy Manual

SLCPD Policy Manual

Policy Manual

The term "supervisor" may also include any person (e.g., officer-in-charge, lead or senior worker) given responsibility for the direction of the work of others without regard to a formal job title, rank or compensation.

UAC - Utah Administrative Code (Example: UAC R728-503-10).

USC - United States Code.

103.5 ISSUING THE POLICY MANUAL

The Policy Manual will be made available to all members of the Department. Upon initial hire, new employees shall be provided access to the Policy Manual.

Employees shall acknowledge their receipt of the manual and confirm their understanding of the policies therein via their Lexipol account. All other members will be provided copies of the policies that are directly applicable to their assignment. The supervising employee over any of these members is responsible for obtaining and keeping documentation of these members' receipt of the Policy Manual, as well as confirmation of understanding.

All Department members shall seek clarification as needed from an appropriate supervisor for any provisions that they do not fully understand.

103.6 PERIODIC REVIEW OF THE POLICY MANUAL

The Chief of Police will ensure that the Policy Manual is periodically reviewed and updated as necessary. No changes shall be made to the manual without authorization from the Chief of Police or the authorized designee.

Members of the Command Staff and the Department's Policy Coordinator are responsible for reviewing proposed or revised policies, procedures, rules, and regulations prior to their promulgation to ensure they do not contradict other existing agency directives or applicable law. This will be accomplished by:

- (a) Reviewing each proposed or revised directive for content, formatting, and contradictions to existing directives.
- (b) Reviewing each proposed or revised directive for content, formatting, and contradictions to existing City Ordinance, and State or Federal Law.
- (c) Consulting with the City Attorney's Office, as appropriate.

The Command Staff will decide whether or not to approve proposed changes. The Command Staff consists of:

- (a) The Chief of Police
- (b) The Assistant Chief
- (c) Deputy Chiefs
- (d) Captains

Salt Lake City Police Department

SLCPD Policy Manual

SLCPD Policy Manual

Policy Manual

103.7 REVISIONS TO POLICY

The release of new and/or revised policy shall occur as needed, based on changing best practices and law. All employees shall be notified via an email generated by the Lexipol system that there has been a change to the Policy Manual, after which they shall sign into their Lexipol account to acknowledge receipt and confirm their understanding of the policy. The supervising employee over any other members of the Department is responsible for notifying those members of any updates to policy that are directly applicable to their assignment. The supervisor is responsible for obtaining and keeping documentation of these members' receipt of the update, as well as their confirmation of understanding.

In addition to the email notification generated by the Lexipol system, a Chief's Order will be distributed electronically by the Office of the Chief's Administrative Secretary announcing the update/change in policy.

Revisions to the Policy Manual will be provided to affected personnel on or before the date the policy becomes effective.

Members are responsible for keeping abreast of Policy Manual revisions.

Each Division Commander will ensure that members under his/her command are aware of any Policy Manual revision. Division Commanders can contact the Policy Coordinator for a report on which employees have or have not reviewed any given policy.

103.7.1 SILENT POLICY UPDATES

Grammatical, structural, and other non-substantive changes to the Policy Manual do not require an acknowledgement from members of the Department. When such changes are made, the Policy Coordinator will conduct a "silent" issuance, which will not result in a notification from the Lexipol system or a Chief's Order. However, the date of revision will be noted on the policy as described below in the ENACTED AND REVISION DATES section, and the previous version will still be archived.

103.7.2 REQUESTING REVISIONS TO POLICY

Any member may suggest revisions to Department policy if he/she believes that it would increase the efficiency or effectiveness of the Department.

Members that are not part of the Command Staff should submit a written request, describing the need and justification for the proposed change, through their chain of command, or directly to the Policy Coordinator. The request will be reviewed by the Command Staff. If the request is declined, the requesting member shall be notified. If the request is approved, the revision to the Policy Manual will be disseminated to Department personnel accordingly.

103.7.3 POLICY ADVISORY COMMITTEE

The Department's Policy Coordinator should form and maintain a Policy Advisory Committee. Members of the committee should represent various assignments and ranks within the Department to ensure a broad input of ideas and experience. The committee will meet twice a year at a

Salt Lake City Police Department

SLCPD Policy Manual

SLCPD Policy Manual

Policy Manual

minimum to review, suggest, and advise on Department policy. The committee may also meet on an *ad hoc* basis at the discretion of the Policy Coordinator.

While the intent of the Policy Advisory Committee is to receive member input on policy changes, the Chief of Police or their designee may promulgate or revise policy at any time, and the existence of the Policy Advisory Committee does not imply that every policy decision will be reviewed by the committee.

103.8 ARCHIVAL OF POLICY

Existing policies, procedures, and directives can be revised, modified, or rescinded but never purged. The Policy Coordinator will ensure that all revisions to the Policy Manual be recorded and archived.

The Office of the Chief's Administrative Secretary shall ensure that available prior Policy Manuals are archived in a suitable manner to ensure long-term reference. The Administrative Assistant will also be responsible for archiving all Chief's Orders.

As the Lexipol system is a web-based system, as a contingency, the Policy Coordinator will ensure that an up-to-date pdf version of the Policy Manual is available on the Department's P drive, for instances in which the Lexipol system is not available. Additionally, in case of a City information systems failure, a copy of the Policy Manual will be kept on a thumb drive at each of the following Department facilities:

1. PSB - located in the Watch Commander's Equipment Cage next to the loading dock.
2. Pioneer Precinct - located in the Pioneer Administrative Offices.
3. Community Connections Center - located at the CIT Sergeant's desk.
4. Crime Lab and Evidence Warehouse - located in the Crime Lab Equipment Storage Room 130.

The Policy Coordinator will be responsible for updating the Policy Manual on each thumb drive at the beginning of every trimester.

103.9 ENACTED AND REVISION DATES

The last section of each policy shall be titled "Revisions". The first entry in the Revision Section of any newly drafted policy shall be labeled "Enacted", followed by the date it was published. The next and subsequent entries shall be labeled "Revised", followed by the date the corresponding revision was published.

The date format is as follows: August 14, 2017

Each time a revision is made to a section of the Policy Manual, the revision date shall be logged in the Revision Section.

103.10 INDIVIDUAL UNIT MANUALS

Individual Units may have specific operations manuals. Manuals should reflect Department policy and procedure, but if found in conflict, Department policy and procedure shall prevail.

Salt Lake City Police Department

SLCPD Policy Manual

SLCPD Policy Manual

Policy Manual

103.11 REVISIONS

Enacted: January 29, 2018

Revised: May 21, 2018

Chapter 2 - Organization and Administration

Organizational Structure and Responsibility

200.1 PURPOSE AND SCOPE

The organizational structure of the Department is designed to create an efficient means to accomplish its mission and goals and to provide for the best possible service to the public.

200.2 DEPARTMENT ORGANIZATION

The Chief of Police is responsible for administering and managing the Salt Lake City Police Department. The Department consists of the Office of the Chief of Police and two Bureaus, each of which contains Divisions and Units within, as described below.

200.2.1 OFFICE OF THE CHIEF OF POLICE

The Office of the Chief consists of the Chief of Police, the Assistant Chief of Police (designated as Chief of Staff), two Deputy Chiefs (designated as Bureau Commanders), the Chief's Executive Officer, the Public Relations Unit. Support staff in the Office of the Chief includes the Chief's Executive Assistant, Peer Support, Executive Protection Detail, Legal Counsel, Government Records Access and Management Act (GRAMA) Office, and the Finance Unit.

The Chief of Police plans, organizes, directs, and controls the personnel and resources of the Police Department. The Chief of Police administers the Department in a manner consistent with the ordinances of the City of Salt Lake, the laws and Constitution of the State of Utah, and the Constitution of the United States of America.

The Chief of Staff works directly with the Deputy Chiefs to address issues that do not require the direct attention of the Chief. The Chief of Staff is responsible for implementing the Chief's strategies and carrying out the duties of the Chief of Police in the absence of the Chief.

200.2.2 ADMINISTRATION BUREAU

The Administration Bureau is commanded by a Deputy Chief and is responsible for all support functions of the Department.

The Administration Bureau is divided into four Divisions, each commanded by a Captain. The Bureau's four Divisions are:

- Support Division
 - Records Unit
 - Records
 - Support Unit

Fleet

Salt Lake City Police Department

SLCPD Policy Manual

SLCPD Policy Manual

Organizational Structure and Responsibility

- Technology
- Body Cameras
- Quartermaster
- Facilities
- Professional Standards Division
 - Training Unit
 - Basic Academy
 - In-Service Academy
 - Internal Affairs Unit
 - Professional Standards
 - Accreditation
 - Audit and Inspection Unit
 - Background Investigations
 - Policy
- Investigations Division
 - Person Crimes Unit
 - Homicide
 - Robbery
 - Special Victims
 - Victim Advocates
 - Domestic Violence
 - CompStat
 - Intelligence Unit
 - Property Crimes Unit
 - Property Crimes
 - Auto Theft/Hit and Run
 - Airport Investigations
 - Financial Crimes
 - Accident Investigations
 - School Resource
 - Crime Lab/Evidence Unit

Salt Lake City Police Department

SLCPD Policy Manual

SLCPD Policy Manual

Organizational Structure and Responsibility

- Crime Lab
- Evidence
- Tactical Unit
 - City Narcotics
 - Organized Crime
 - Hazardous Devices Unit
 - Special Weapons and Tactics (SWAT)
- DEA Metro
 - DEA Task Force

200.2.3 OPERATIONS BUREAU

The Operations Bureau is commanded by a Deputy Chief and is responsible for the overall direction, control, and coordination of field operations.

The Operations Bureau is divided into four Divisions, each commanded by a Captain. The Bureau's four Divisions are:

- Airport Division
 - Patrol
 - Airport Canine
 - Airport Hazardous Device Unit (HDU)
 - Joint Terrorism Task Force
 - Airport Bike Patrol
- Central Division
 - Patrol
 - Crisis Intervention Team (CIT)
 - Homeless Outreach Service Team (HOST)
 - Social Workers
 - Central Bike Patrol
 - Park Squad
 - Motors
 - Special Events
 - Secondary Employment
 - Public Order Unit (POU)
- Pioneer Division
 - Patrol

Salt Lake City Police Department

SLCPD Policy Manual

SLCPD Policy Manual

Organizational Structure and Responsibility

- Telephonic Officers
- Gang Unit
- Pioneer Bike Unit
- Liberty Division
 - Patrol
 - Patrol K9
 - Liberty Bike Unit
 - Desk Officers
 - Community Intelligence Unit (CIU)
 - Community Outreach Unit (COU)

The Airport, Central, Liberty, and Pioneer Patrol Divisions have daily operations directed by a cadre of Watch Commanders (Lieutenants).

200.2.4 ORGANIZATIONAL CHART

See attachment: [Salt Lake City Police Department Organizational Chart v2.15 2020-08-17.pdf](#)

200.3 COMMAND PROTOCOL

200.3.1 SUCCESSION OF COMMAND

The Chief of Police exercises command over all personnel in the Department. During planned absences the Chief of Police will designate an Acting Chief of Police.

In the event that no Acting Chief of Police is appointed, the line of succession is as follows:

- Assistant Chief
- Deputy Chief by seniority in rank
- Captain by seniority in rank

In case of incapacitating injury to, or death of, the Chief of Police, the Assistant Chief is responsible for the operation of the Department until the Mayor appoints a replacement.

200.3.2 CHAIN OF COMMAND - SWORN PERSONNEL

In normal day-to-day operations, the echelon of command for sworn members of the Department is as follows:

- Chief of Police
- Assistant Chief
- Deputy Chief
- Captain
- Lieutenant

Salt Lake City Police Department

SLCPD Policy Manual

SLCPD Policy Manual

Organizational Structure and Responsibility

- Sergeant
- Officer/Detective

200.3.3 CHAIN OF COMMAND - NON-SWORN PERSONNEL

Non-sworn members shall have the same authority as sworn members in the same echelon, except as relating to the performance of, or review of, police duties.

The echelon of command for non-sworn members of the Department is as follows:

- Chief of Police
- Assistant Chief
- Deputy Chief
- Captain
- Director/Lieutenant
- Supervisor/Sergeant
- Non-sworn Member/Police Officer

200.3.4 COMMAND PROTOCOL IN MULTI-UNIT OPERATIONS

Command protocol in situations involving personnel of different units or sections engaging in a single operation is as follows:

- The command structure always follows the chain of command.
- Whenever the command structure is not easily distinguishable by rank, responsibility of command remains with the command officer having primary functional responsibility.
 - Primary functional responsibility means matters that fall within an officer's normal responsibilities and duties.

200.3.5 UNITY OF COMMAND

The principles of unity of command ensure efficient supervision and control within the Department. Generally, each employee shall be accountable to one supervisor at any time for a given assignment or responsibility. Except where specifically delegated authority may exist by policy or special assignment (e.g. K-9, SWAT), any supervisor may temporarily direct any subordinate if an operational necessity exists.

200.3.6 ORDERS

Members shall respond to and comply with the lawful order of superior officers and other proper authority. This includes orders from a superior that an employee of the same or lesser rank relays.

200.4 AUTHORITY AND RESPONSIBILITY

Consistent with the principles of sound supervisory practices, all supervisory personnel will be held reasonably accountable for the performance of their subordinates. Supervisory personnel

Salt Lake City Police Department

SLCPD Policy Manual

SLCPD Policy Manual

Organizational Structure and Responsibility

must take reasonable steps to promote their subordinates' understanding of, and compliance with, Department rules and regulations through:

- Personal supervision
- Delegation of authority
- Ongoing training
- Clarification of directives, orders, and procedures

Irrespective of rank, each employee within the organization has clearly articulated duties and responsibilities. Each employee is hereby delegated the authority necessary to effectively execute those responsibilities. Each employee will also be held accountable for the appropriate application of that delegated authority.

200.5 REVISIONS

Enacted: January 29, 2018

Revised: May 21, 2018

Revised: November 8, 2018

Revised : June 29, 2020

Administrative Communications

201.1 PURPOSE AND SCOPE

Administrative communications of the Department are governed by the following policies.

201.2 CHIEF'S ORDERS

Chief's Orders establish an interdepartmental communication that may be used by the Chief of Police to make immediate changes to policy. Chief's Orders will immediately modify or change and supersede sections of this manual to which they pertain.

Chief's Orders will be numbered consecutively starting with the year, followed by the appropriate sequenced number. For example, 17-01 would signify the first Chief's Order for the year 2017.

201.2.1 ACKNOWLEDGEMENT OF CHIEF'S ORDERS

All employees are required to read and obtain any necessary clarification of all Chief's Orders. All employees are required to acknowledge receipt and confirm understanding of policy changes promulgated by Chief's Orders (see the Policy Manual Policy).

201.3 CHIEF'S MEMORANDUMS

Chief's Memorandums (Memos) may be issued periodically by the Chief of Police, or their designee, to announce and document Department procedural changes, promotions, transfers, hiring of new personnel, separations, training, personnel and group commendations, clarify Department policy and procedure, etc. Chief's Memos are not self-canceling and may be used as a direct order.

Chief's Memos will be numbered consecutively starting with the year, followed by the appropriate sequenced number. For example, 17-01 would signify the first Chief's Memo for the year 2017.

201.3.1 ACKNOWLEDGEMENT OF CHIEF'S MEMOS

If a Chief's Memo announces a change/update to the Department's policy manual or procedure manual, all employees are required to acknowledge receipt and confirm understanding of the change promulgated by the Chief's Memo.

201.4 SPECIAL ORDERS

Special orders are issued for the purpose of disseminating information or instructions concerning an event or function that requires the coordinated effort of two or more Divisions.

Special orders will be issued to those employees affected, and those employees are responsible for maintaining all such current orders.

201.5 CORRESPONDENCE

In order to ensure that the letterhead and name of the Department are not misused, all external correspondence shall be on Department letterhead. Personnel should use Department letterhead only for official business.

Salt Lake City Police Department

SLCPD Policy Manual

SLCPD Policy Manual

Administrative Communications

201.6 SURVEYS

All surveys made in the name of the Department shall be authorized by a Division Commander or above.

201.7 REVISIONS

Enacted: January 29, 2018

Emergency Management Plan

202.1 PURPOSE AND SCOPE

The City has prepared an Emergency Management Plan Manual for use by all employees in the event of a major disaster or other emergency events. The manual provides for a strategic response by all employees and assigns specific responsibilities in the event the plan is activated.

The Department has also developed an Emergency Operations Plan and a Field Operations Guide to guide officers on how to respond to critical incidents.

The Chief of Police will designate an Emergency Management Coordinator for the Department. The Coordinator is tasked with planning the Department's response to critical incidents. The Coordinator should be of the rank of Captain or above.

202.2 ACTIVATING THE EMERGENCY PLAN

The Emergency Management Plan can be activated in a number of ways. For the Police Department, the Chief of Police or the highest ranking official on-duty may activate the Emergency Management Plan in response to a major emergency.

202.2.1 RECALL OF PERSONNEL

In the event that the Emergency Management Plan is activated, all employees of the Salt Lake City Police Department are subject to immediate recall. Employees may also be subject to recall during extraordinary circumstances as deemed necessary by the Chief of Police or the authorized designee.

Failure to promptly respond to an order to report for duty may result in discipline.

202.3 EMERGENCY OPERATIONS PLAN AND FIELD OPERATIONS GUIDE

In addition to the City's Emergency Management Plan, the Department has developed an Emergency Operations Plan (EOP) and a Field Operations Guide (FOG) to guide officers on how to respond to critical incidents. The EOP and FOG follow standard Incident Command System (ICS) protocols. Supervisors and officers should familiarize themselves with the EOP and FOG and what roles police personnel will play when these plans are implemented.

202.3.1 UPDATING OF MANUALS

The Emergency Management Coordinator shall review and update, as needed, the EOP and FOG.

202.4 BUILDING EVACUATION PLAN

In the event of a disaster or emergency which requires evacuation of any department facility, all employees shall follow implemented evacuation plans and posted exit strategies.

202.5 TRAINING

Annual training shall be provided to affected personnel on the Department's Emergency Operations Plan and the Incident Command System (ICS).

Salt Lake City Police Department

SLCPD Policy Manual

SLCPD Policy Manual

Emergency Management Plan

At least once every two years, training consisting of a tabletop or full-scale exercise will occur to assess the Department's capabilities with the Emergency Operations Plan and the Incident Command System (ICS).

Training on the City's Emergency Management Plan should occur on a periodic basis.

All training shall be documented.

202.6 REVISIONS

Enacted: January 29, 2018

Revised: January 19, 2018

Staffing Levels

203.1 PURPOSE AND SCOPE

The purpose of this policy is to ensure that proper field staffing and supervision is available for all shifts and events. The Department intends to balance employees' needs with the need to meet operational demands. While balance is desirable, the paramount concern is meeting operational requirements of the Department.

203.2 PATROL STAFFING

Patrol staffing minimums shall be determined on a shift basis (i.e., Day Shift, Afternoon Shift, Graveyard Shift). Only those officers specifically assigned to uniformed patrol duties in the Patrol Divisions will be counted in the minimum staffing determinations. Generally, minimum staffing is 70% of the full complement of officers assigned to a given shift. Any deviation from the 70% minimum must be approved by the Watch Commander.

Assignments to shifts, service areas, and days off are bid for on a trimester basis. Bidding takes place in order of Department seniority for non-supervisor positions. Supervisory positions bid by seniority in rank.

The trimester rotations occur around the first week of January, May, and September, based on the City's payroll cycle. The Patrol Divisions' Administrative Lieutenants are responsible for conducting the trimester sign-ups, which should occur approximately 3 to 4 weeks before a trimester rotation.

203.3 NON-PATROL STAFFING

Staffing minimums in non-patrol Units will be decided upon by their respective chains of command, taking into consideration the operational requirements of the Department and employees' needs.

Units outside of the Patrol Division that also rotate schedules every trimester should utilize the same rotation schedule as the Patrol Divisions. Regardless of a Unit's frequency of shift rotation, bidding for shifts worked and days off, when applicable, will be determined by Department seniority for non-supervisory positions. Supervisory positions, when applicable, bid by seniority in rank.

203.4 FIELD SUPERVISION

Minimum staffing levels should result in the scheduling of at least two Patrol Sergeants and one Watch Commander whenever possible.

203.4.1 SUPERVISOR COVERAGE

In order to accommodate training, leave time, and other unforeseen circumstances, an officer, with prior authorization from a Patrol Lieutenant, may be used as a field supervisor in place of a field Sergeant. Command Staff and/or a Patrol Lieutenant shall select the employee most qualified to assume the responsibilities of acting supervisor, regardless of seniority.

The acting supervisor shall confer with an on-duty supervisor from another sector or the Watch Commander whenever a major incident is assigned to any officer that they are supervising and/or a situation arises that the acting supervisor is unsure how to handle.

Salt Lake City Police Department

SLCPD Policy Manual

SLCPD Policy Manual

Staffing Levels

An employee assigned to work as an acting supervisor will be compensated in accordance with the applicable memorandum of understanding, City policy, or compensation plan.

203.5 SPECIAL EVENTS

Special event coordination is a function of the Special Operations Division. The coordination, organization, and staffing of special events is conducted by the Motor/Special Events Lieutenant.

Special events are divided into two categories: special events and large special events.

203.5.1 SPECIAL EVENTS

Special events are preplanned events that require police employee staffing to ensure a successful and safe event. The majority of events organized by the Special Operations Division are classified as special events and staffing will be filled by the Motor Squad and/or by utilizing officers who volunteer for the duty. If not enough officers volunteer to fill the positions required for the event, a reverse seniority staffing mandate may be used.

203.5.2 LARGE SPECIAL EVENTS

Large special events are preplanned events that require the police department to restrict time off in order to ensure a successful and safe event. Large special event staffing and sign-up will be accomplished in the following manner:

- (a) All employees will be given notice that a sign-up will be taking place at least seven (7) days prior to the actual sign-up. The notice will include the date and time the sign-up will commence and a preview of the event positions and start times.
- (b) As a result of a reverse seniority staffing mandate, some positions and start times may be blocked out from open sign-up and made available to only those officers that may be coming off shift and required to work.
- (c) Sign-ups will take place either on the secondary employment system (POSE), or in person. If an in person sign-up is utilized, once the sign-up for the event has commenced, officers may sign up for themselves and sign up as a proxy for one additional officer. Each additional proxy will require the officer signing up to go through the line again. Special Operations Division staff will not act as proxies.
- (d) As a result of a reverse seniority staffing mandate, no employee will be exempt from a large special event without their Bureau Commander's approval.
- (e) Large events may require a pool of officers identified prior to the event for use as backfill for unforeseen circumstances.

203.5.3 OPERATION PLAN AND ORDERS

The Special Event Coordinator will distribute operational plans and orders via e-mail two (2) weeks prior to the event.

203.5.4 COMPENSATION

Any overtime or compensatory time resulting from work at a Special Event will be processed and compensated as agreed and in effect through the applicable Memorandum of Understanding and City policy (see the Overtime Compensation Requests Policy).

Salt Lake City Police Department

SLCPD Policy Manual

SLCPD Policy Manual

Staffing Levels

203.6 REVISIONS

Enacted: January 29, 2018

Revised: September 12, 2018

Training

204.1 PURPOSE AND SCOPE

It is the policy of the Department to administer a training program that will provide for the professional growth and continued development of its personnel. By doing so, the Department will ensure its personnel possess the knowledge and skills necessary to provide a professional level of service that meets the needs of the community.

204.2 PHILOSOPHY

The Department seeks to provide ongoing training and encourages all personnel to participate in advanced training and formal education on a continual basis. Training is provided within the confines of funding, requirements of a given assignment, staffing levels, and legal mandates.

204.3 OBJECTIVES

The objectives of the Training Program are to:

- (a) Enhance the level of law enforcement service to the public.
- (b) Increase the technical expertise and overall effectiveness of Department personnel.
- (c) Provide for continued professional development of Department personnel.

204.4 TRAINING PLAN

The Training Lieutenant is responsible for planning the Department's annual training schedule, which will address the following state requirements:

- Compliance with POST mandated annual certified training of not less than 40 hours (Utah Code 53-6-202(4)(a)).
- Firearms qualifications.
- Arrest control tactics (defensive tactics).

The schedule should also address the following Department requirements:

- Legislative Changes
- State Mandated Training
- Critical Issues Training

204.5 INSTRUCTOR QUALIFICATIONS

Personnel assigned to the Training Unit in a full-time capacity as instructors shall receive instructor development training, which includes, at a minimum:

- (a) Lesson plans;
- (b) Performance objectives;
- (c) Instructional techniques;
- (d) Testing and evaluation techniques; and

Salt Lake City Police Department

SLCPD Policy Manual

SLCPD Policy Manual

Training

- (e) Resource availability and use.

204.6 TRAINING ATTENDANCE

All employees assigned to attend training shall attend unless previously excused by their immediate supervisor. Excused absences from mandatory training should be limited to:

- (a) Court appearances
- (b) Vacation
- (c) Sick leave
- (d) Physical limitations preventing the employee's participation
- (e) Emergency situations

When an employee is unable to attend mandatory training, that employee shall:

- (a) Notify his/her supervisor as soon as possible, but no later than 15 minutes after the start of training.
- (b) Document his/her absence in a memorandum to his/her supervisor.
- (c) Make arrangements through his/her supervisor and the Training Lieutenant to attend an alternate date.

204.6.1 SWORN PERSONNEL ANNUAL IN-SERVICE TRAINING

All sworn personnel will complete an annual in-service training program provided by the Training Unit. The annual in-service program shall include legal updates.

204.7 TRAINING DOCUMENTATION

The Training Unit is responsible for updating employees' training records following their completion of Departmental training.

If an employee attends a non-Departmental training program, they are responsible for providing their immediate supervisor proof of attendance and completion. The employee's supervisor is responsible for entering the training hours into the Department's online training program. It is the employee's responsibility to provide certificates and/or documentation of completion to the Training Unit, who will then place the certificate/documentation in the employee's training file.

204.8 DAILY TRAINING BULLETINS

204.8.1 LEXIPOL DAILY TRAINING BULLETINS

The Lexipol Daily Training Bulletins (DTBs) are contained in the web-accessed Lexipol system and provide training on the Salt Lake City Police Department policy manual and other important topics. Generally, one training bulletin is available for each work week of the month. However, the number of DTBs may be adjusted by the Policy Coordinator.

Depending on the content of Daily Training Bulletins, sworn and non-sworn personnel will be assigned accordingly to participate in DTBs. The content of the Lexipol DTBs is copyrighted material and shall not be shared with others outside of the Department.

Salt Lake City Police Department

SLCPD Policy Manual

SLCPD Policy Manual

Training

Employees should complete each DTB at the beginning of their shift or as otherwise directed by their supervisor. Employees should not allow uncompleted DTBs to build up over time. Personnel may be required to complete DTBs missed during extended absences (e.g., vacation, medical leave, etc.) upon returning to duty. Although the DTB system can be accessed from any Internet active computer, employees shall only take DTBs as part of their on-duty assignment unless directed otherwise by a supervisor.

Supervisors will be responsible for monitoring the progress of personnel under their command to ensure compliance with this policy.

204.8.2 DEPARTMENT-GENERATED DAILY TRAINING BULLETINS

As needed, the Department may issue department-generated training via the DTB system. When this occurs a Chief's Memorandum will announce the training, along with the date specified personnel are required to complete it by. Personnel that are identified in the Chief's Memorandum as being required to complete the training shall complete it in the specified time frame, unless on department-approved extended absences (e.g., vacation, medical leave, etc.). Personnel will be required to complete the department-generated DTBs missed during extended absences upon returning to duty. Although the DTB system can be accessed from any Internet active computer, employees shall only take DTBs as part of their on-duty assignment unless directed otherwise by a supervisor.

Supervisors will be responsible for monitoring the progress of personnel under their command to ensure compliance with this policy.

204.10 POLICE ACADEMY

The Training Unit oversees the Salt Lake City Police Academy. The goal of the Academy is to graduate well-trained police officers by exposing recruits to a rigorous and challenging course of instruction. The curriculum has been designed to provide recruits with the necessary knowledge and skills to successfully operate as a Salt Lake City police officer.

The administrative and operating procedures for the academy can be found in the Salt Lake City Police Department Police Academy Recruit Manual.

204.10.1 RECRUIT TRAINING

Personnel hired as police trainees are assigned to attend the Salt Lake City Police Department Police Academy, which is a Utah POST certified law enforcement basic academy. These trainees are referred to as "recruits", and are not sworn peace officers. Once assigned to attend the academy, recruits are under the direct supervision of academy staff.

Pursuant to Utah Code 53-6-202(3), the academy curriculum shall be appropriate for the basic training of peace officers in the techniques of law enforcement. The use of evaluation techniques designed to measure competency in the required knowledge, skills, and abilities of peace officers will be used to determine if the recruits satisfactorily complete the basic training. A recruit must satisfactorily complete the basic training academy to become a sworn peace officer (Utah Code

Salt Lake City Police Department

SLCPD Policy Manual

SLCPD Policy Manual

Training

53-6-202(4)(a)) and progress to the Field Training Program, or prior to assignment in any capacity in which they are allowed to carry a weapon or be in a position to make an arrest.

Recruits will be supplied with a Recruit Manual upon entrance to the academy.

204.11 REPORTING

The Training Lieutenant shall ensure that all required training records are forwarded to POST in the appropriate format pursuant to UAC R728-410-6.

204.12 REVISIONS

Enacted: January 29, 2018

Revised: February 8, 2018

Revised: May 21, 2018

Electronic Mail

205.1 PURPOSE AND SCOPE

The purpose of this policy is to establish guidelines for the proper use and application of the Department's electronic mail (email) system by employees of this department. Email is a communication tool available to employees to enhance efficiency in the performance of job duties and is to be used in accordance with generally accepted business practices and current law. Regularly scheduled on-duty employees are required to read and respond to their work e-mails daily.

205.2 EMAIL RIGHT OF PRIVACY

All email messages, including any attachments, that are transmitted over department networks are considered department records and therefore are department property. The Department reserves the right to access, audit or disclose, for any lawful reason, any message, including any attachment, that is transmitted over its email system or that is stored on any department system.

The email system is not a confidential system and therefore is not appropriate for confidential communications. If a communication must be confidential, an alternative method to communicate the message should be used. Employees using the department email system shall have no expectation of privacy concerning communications transmitted over the system.

Employees should not use personal accounts to exchange email or other information that is related to the official business of the Department.

205.3 PROHIBITED USE OF EMAIL

Sending derogatory, defamatory, obscene, disrespectful, sexually suggestive and harassing or any other inappropriate messages on the email system will not be tolerated and may result in discipline.

Employees will not use the city email system to promote any private business or service, or to advertise any items for sale. Employees will not use the city email system to send mass emails to promote or advertise non-work related events or gatherings without the prior administrative approval. The city's Employee Forum is the proper venue for these types of distribution.

Police-All emails for investigative purposes shall not be sent unless it is an emergency situation (i.e., missing child, bank robbery suspect, etc). All investigative information will be placed on SmartForce™.

It is a violation of this policy to transmit a message under another user's name. Users are strongly encouraged to log off the network when their computer is unattended. This added security measure would minimize the misuse of an individual's email, name and/or password by others.

Salt Lake City Police Department

SLCPD Policy Manual

SLCPD Policy Manual

Electronic Mail

205.4 EMAIL RECORD MANAGEMENT

Email may, depending upon the individual content, be a public record under the Utah Government Records Access and Management Act (Utah Code 63G-2-101 et seq.) and must be managed in accordance with the established records retention schedule and in compliance with state law.

205.5 REVISIONS

Enacted: January 29, 2018

Police Facilities

206.1 PURPOSE AND SCOPE

This policy provides guidelines and procedures for the security and use of Department owned or operated facilities.

206.2 POLICY

The Administrative Division is responsible for managing the provisions of all security services and care of Department facilities. Notwithstanding, all members are responsible for taking reasonable precautions to ensure their personal safety and the security of personal and department property. Police facilities include, but are not limited to, the Public Safety Building, Pioneer Precinct, Crime Lab and Evidence Warehouse, training facilities, and the Community Connection Center.

206.3 CARE OF FACILITIES

Employees shall maintain orderly and clean premises, desks, lockers, distribution mailboxes, and other facilities designated for their use.

Employees will not paint or make changes to walls, floors, workstations or ceilings unless pre-approved by the Administrative Division Captain.

Employees may padlock lockers where applicable, however, if the locker has to be entered due to exigent circumstances, the lock may be cut. The Department will not reimburse members for cut or damaged locks.

206.4 SECURITY OF POLICE FACILITIES

206.4.1 RESTRICTED AREAS

Non-public areas in Department facilities shall be identified with a sign at the entrances stating, "Restricted Non-Public Area - Visible Identification Required." This will be displayed in English and Spanish.

Non-uniformed employees, interns, volunteers, vendors, and service and delivery workers shall exhibit their photo credential card while in a Department facility. Identification shall be conspicuously visible at all times and displayed on an outer garment attached on or above the waist.

206.4.2 VISITORS

When possible, visitors are required to show picture identification prior to admission to restricted areas of police buildings. The member working at the front desk is responsible for confirming the identity of the visitor prior to issuing a visitor pass and ensuring the documentation of it on the visitor's log. If a visitor has no identification, but is there to meet with Police or Fire Department personnel, the employee being met or their representative shall come to the front desk, personally issue the visitor pass, and escort the visitor to their destination.

Salt Lake City Police Department

SLCPD Policy Manual

SLCPD Policy Manual

Police Facilities

In the Community Connection Center guest badges will not be issued for individuals accessing areas designated for use by the social workers. However, all individuals visiting this area shall be escorted by a Department employee or designated community partner at all times. Before individuals are let into the social worker designated areas, all bags and large items the individual has will be locked in a designated locker, while being observed by a Department employee or designated community partner.

Visitors must be able to articulate a specific need to enter a restricted area. Department employees are authorized to courteously inquire as to that need.

Packages, briefcases, purses and other items being brought into police facilities by visitors are subject to a visual scan. Members may ask visitors to open these items and move contents aside to complete the visual scan.

No weapons are allowed in any police facility. It is the duty of the escorting employee to screen visitors for weapons before allowing the visitor to enter a restricted area. Current law enforcement officers or retired Salt Lake City police officers with an Armed Retired Officer identification card are allowed to enter the building with a firearm.

If a Department employee grants access, visitors shall:

- Be accompanied by a personal escort at all times.
- Display a Department approved visitor pass on their outer clothing.
- Be required to complete a visitor log. This log shall include the visitor's name, reason for the visit, time of the visit, and who escorted the visitor.

At the conclusion of the visitor's business within the building, the employee or their representative will escort the visitor to the front desk area, retrieve the visitor pass, log them out on the visitor's log, and see them past the security doors.

206.4.3 MAGNETOMETERS

Persons entering the Public Safety building or Pioneer Precinct building will be required to adhere to the following procedures:

- All non-law enforcement visitors will be required to walk through the magnetometers. Visitors with items on their person containing metal may set the items aside at the front desk prior to walking through the magnetometer. If the magnetometer alarm is activated:
 - A hand held metal detector will be used to further investigate the location of the metal on the person, and/or;
 - The person will be asked to step back outside of the metal detector and remove other items from their person containing metal prior to again stepping through the magnetometer.
- Visitors passing through the magnetometers may be subject to a search or denied access if no explanation can be provided for an alarm being triggered.

Salt Lake City Police Department

SLCPD Policy Manual

SLCPD Policy Manual

Police Facilities

- Public safety employees or law enforcement personnel from other agencies will not be required to walk through the magnetometer as long as they present valid public safety identification and have that identification or a badge displayed.

206.4.4 CONCEALED CARRY PERMITS

No firearms are allowed in any police facility except when carried by an authorized law enforcement officer or retired Salt Lake City police officer with an Armed Retired Officer identification card.

Visitors who hold a concealed carry permit and are armed will be denied access to the building.

Civilian employees with a concealed carry firearm permit may carry the weapon to and from work, but not during work hours or within police buildings. Civilian employees with a concealed-carry permit will lock the weapon in a locker designated by the department prior to reporting for duty.

206.4.5 UNAUTHORIZED INDIVIDUALS

Employees shall challenge individuals in a restricted area who do not have proper identification and make a determination as to the nature of their business, or bring the matter to the attention of a supervisor or sworn member of the Department.

Individuals not having any legitimate business in a restricted area shall be courteously escorted to a public area of the facility.

If resistance or behavior of a threatening or suspicious nature is encountered, sworn personnel shall be notified or a call to 911 initiated.

206.5 VENDORS, SERVICE AND DELIVERY WORKERS

Individuals doing business with the Department, such as postal workers, building maintenance, etc., who are wearing their company uniform must display visible visitor passes.

All vendors and service providers will check in and check out at a facility's front lobby desk except when special arrangements have been made and authorized by the Administrative Division Captain.

On approval of the Administrative Division Captain, vendors and janitors who regularly work at the building may be issued a vendor identification card that is renewable annually. Vendors with current department-issued identification are not required to be escorted in police facilities, but must still pass through a magnetometer if present.

206.6 BACKGROUND CLEARANCE

Before a Department-issued identification card is authorized for any person, a criminal history check will be conducted. The following items will be disqualifiers for a Department-issued identification:

- Currently on probation or parole for a criminal offense.
- Any felony conviction.
- Any misdemeanor conviction in the last 4 years.

Salt Lake City Police Department

SLCPD Policy Manual

SLCPD Policy Manual

Police Facilities

- A pending criminal charge.
- Any drug conviction in the last 5 years.
- Any offense against government or government employees (e.g., resisting arrest, interfering with an arrest, false information to a police officer, etc.)

Any of the above items may be waived on a case-by-case basis by the Administrative Division Captain.

Before a Department-issued identification card is issued, the person seeking the card must also be fingerprinted and sign a UCJIS agreement as outlined in the Protected Information Policy.

Any person without the above clearances must be escorted at all times while in any Department facility.

206.7 COMMUNITY ROOMS

The community rooms at the Public Safety Building and Pioneer Precinct are intended as multi-use facilities for both the Department and the community. Use by community organizations is limited to non-commercial and non-profit individuals and groups.

The needs and requirements of the Department will take precedence over other requests.

As a general rule, food and beverages, with the exception of water, will not be allowed in the community rooms. Events and organizations with catering or food requests will need to provide a \$200 cleaning deposit made payable to the Salt Lake City Police Department.

Requests specific to table, seating, and room arrangements must be made no later than 72 hours prior to the event.

Under no circumstances should the partition walls or audio-visual equipment be interfered with or changed without the permission and instruction from the Administrative Division at the Public Safety Building or the Training Unit at the Pioneer Precinct.

Organizations and/or after hours functions requiring audio-visual equipment or other assistance will be charged a \$100 fee for payment of technical staff.

206.7.1 PROCEDURE FOR RESERVING ROOMS

All reservation requests for use of the Public Safety Building community and media rooms will be coordinated through the Office of the Chief's administrative secretary either in person or by telephone at (801) 799-3802.

All reservation requests for use of the Pioneer Precinct community rooms will be coordinated through the Training Unit staff either in person or by telephone at (801) 799-4300.

All parties and organizations requesting the use of these rooms will have to provide a designated contact person. The contact person will provide the following information:

- Contact phone number.
- Signature accepting responsibility for the room.

Salt Lake City Police Department

SLCPD Policy Manual

SLCPD Policy Manual

Police Facilities

- Cleaning deposit, if applicable.

The primary use of these rooms is for the training of Department staff. Although uncommon, this may on occasion necessitate a short notice cancelation of a reservation.

206.8 REVISIONS

Enacted: January 29, 2018

Law Enforcement Service Agreements

207.1 PURPOSE AND SCOPE

The purpose of this policy is to provide clear directives for the preparation of written agreements governing law enforcement services provided by the Salt Lake City Police Department to outside agencies or entities. Written agreements shall be required anytime the Salt Lake City Police Department undertakes a contractual obligation to provide City resources for law enforcement purposes to any other agency or entity.

207.2 PRINCIPLES OF CONTRACT CONSTRUCTION FOR LAW ENFORCEMENT SERVICES CONTRACTS

All contracts for law enforcement services shall be written agreements including, at a minimum, the following terms, conditions, and information:

- (a) A statement of the specific services to be provided;
- (b) Specific language dealing with financial agreements between the parties;
- (c) Specification of the records to be maintained concerning the performance of services by the provider agency;
- (d) Language dealing with the duration, modification, and termination of the contract;
- (e) Specific language dealing with legal contingencies;
- (f) Stipulation that the provider agency maintains control over its personnel;
- (g) Specific arrangements for the use of equipment and facilities; and
- (h) A procedure for review and revision, if needed, of the agreement.

207.2.1 REVIEW AND APPROVAL OF CONTRACTS

All contracts for law enforcement services shall be reviewed and authorized by the Chief of Police, the City Attorney's Office, and the Mayor of Salt Lake City.

207.3 MULTI-JURISDICTIONAL INVESTIGATIVE TASK FORCES

The Salt Lake City Police Department allows for participation in formal, long-term, multijurisdictional investigative Task Forces as staffing levels permit. Task Force activities require a Memorandum of Understanding (MOU), which will include:

- (a) The purpose;
- (b) Delineation of authority and responsibilities; and
- (c) A procedure for review and revision, if needed, of the MOU.

207.4 REVISIONS

Enacted: January 29, 2018

Retiree Concealed Firearms

208.1 PURPOSE AND SCOPE

The purpose of this policy is to provide guidelines for the issuance, denial, suspension or revocation of Salt Lake City Police Department identification cards under the Law Enforcement Officers' Safety Act (LEOSA) and Utah law (18 USC § 926C; Utah Code 53-5-704).

208.2 POLICY

It is the policy of the Salt Lake City Police Department to provide identification cards to qualified former or retired officers as provided in this policy.

208.3 LEOSA

The Chief of Police may issue an identification card for LEOSA purposes to any qualified former officer of this department who (18 USC § 926C(c)):

- (a) Separated from service in good standing from this department as an officer.
- (b) Before such separation, had regular employment as a law enforcement officer for an aggregate of 10 years or more or, if employed as a law enforcement officer for less than 10 years, separated from service after completing any applicable probationary period due to a service-connected disability as determined by this department.
- (c) Has not been disqualified for reasons related to mental health.
- (d) Has not entered into an agreement with this department where the officer acknowledges that he/she is not qualified to receive a firearm qualification certificate for reasons related to mental health.
- (e) Is not prohibited by federal law from receiving or possessing a firearm.

208.3.1 LEOSA IDENTIFICATION CARD FORMAT

The LEOSA identification card should contain a photograph of the former officer and identify him/her as having been employed as an officer.

If the Salt Lake City Police Department qualifies the former officer, the LEOSA identification card or separate certification should indicate the date the former officer was tested or otherwise found by the Department to meet the active duty standards for qualification to carry a firearm.

208.3.2 AUTHORIZATION

Any qualified former law enforcement officer, including a former officer of this department, may carry a concealed firearm under 18 USC § 926C when he/she is:

- (a) In possession of photographic identification that identifies him/her as having been employed as a law enforcement officer and one of the following:
 1. An indication from the person's former law enforcement agency that he/she has, within the past year, been tested or otherwise found by the law enforcement agency to meet agency-established active duty standards for qualification in firearms training to carry a firearm of the same type as the concealed firearm.

Salt Lake City Police Department

SLCPD Policy Manual

SLCPD Policy Manual

Retiree Concealed Firearms

2. A certification, issued by either the state in which the person resides or by a certified firearms instructor who is qualified to conduct a firearms qualification test for active duty law enforcement officers within that state, indicating that the person has, within the past year, been tested or otherwise found to meet the standards established by the state or, if not applicable, the standards of any agency in that state.
 - (b) Not under the influence of alcohol or another intoxicating or hallucinatory drug or substance.
 - (c) Not prohibited by federal law from receiving a firearm.
 - (d) Not in a location prohibited by Utah law or by a private person or entity on his/her property if such prohibition is permitted by Utah law.

208.4 FORMER OFFICER RESPONSIBILITIES

A former officer with a card issued under this policy shall immediately notify the Watch Commander of his/her arrest or conviction in any jurisdiction, or that he/she is the subject of a court order, in accordance with the Reporting of Employee Convictions Policy.

208.4.1 RESPONSIBILITIES UNDER LEOSA

In order to obtain or retain a LEOSA identification card, the former officer shall:

- (a) Sign a waiver of liability of the Department for all acts taken related to carrying a concealed firearm, acknowledging both his/her personal responsibility as a private person for all acts taken when carrying a concealed firearm as permitted by LEOSA and also that these acts were not taken as an employee or former employee of the Department.
- (b) Remain subject to all applicable department policies and federal, state and local laws.
- (c) Demonstrate good judgment and character commensurate with carrying a loaded and concealed firearm.
- (d) Successfully pass an annual criminal history background check indicating that he/she is not prohibited by law from receiving or possessing a firearm.

208.5 DENIAL, SUSPENSION OR REVOCATION

A LEOSA identification card may be denied or revoked upon a showing of good cause as determined by the Department. In the event that an identification card is denied, suspended or revoked, the former officer may request a review by the Chief of Police. The decision of the Chief of Police is final.

208.6 PROCEDURE

[Salt Lake City Police Department Procedure Manual: 201.2 OBTAINING A LEOSA IDENTIFICATION CARD - PROCEDURE](#)

208.7 REVISIONS

Enacted: January 29, 2018

Concealed Weapon License

209.1 PURPOSE AND SCOPE

Concealed weapon permit holders are subject to suspension or revocation of the permit upon commission of certain acts. This policy will provide guidance to the officer for notification to the Bureau of Criminal Identification of circumstances that may be grounds for review of a concealed weapon permit (Utah Code 53-5-704).

209.2 QUALIFIED APPLICANTS

In order to continue to qualify for a permit to carry a concealed weapon, a person (Utah Code 53-5-704):

- (a) Must not have been convicted of a felony.
- (b) Must not have been convicted of any crime of violence.
- (c) Must not have been convicted of any offense involving the use of alcohol.
- (d) Must not have been convicted of any offenses involving the unlawful use of narcotics or other controlled substances.
- (e) Must not have been convicted of any offenses involving moral turpitude, as defined in UAC R722-300-3.
- (f) Must not have been convicted of any offense involving domestic violence.
- (g) Must not have been adjudicated by a court of a state or of the United States as mentally incompetent, unless the adjudication has been withdrawn or reversed; must not have been committed to a mental institution or found not guilty by reason of insanity for a felony offense; and must not have been found mentally incompetent to stand trial for a felony offense.
- (h) Must not be a person who is illegally or unlawfully in the United States.
- (i) Must not have been dishonorably discharged from the armed forces.
- (j) Must not have renounced his/her citizenship after having been a citizen of the United States.
- (k) Must not have committed any crime or act that would disqualify the person from the possession of a weapon under federal law.
- (l) Must not be on the voluntary restricted list (Utah Code § 53-5c-301).

An officer who has reason to believe that a concealed weapon permit holder or applicant has violated one of the foregoing provisions should notify the Department of Public Safety Bureau of Criminal Identification and document the reasons in an information report. The Bureau of Criminal Identification may then review the person's eligibility to hold a concealed weapon permit.

[Salt Lake City Police Department Procedure Manual: 202.2 NOTIFICATION TO BCI](#)

209.3 REVISIONS

Enacted: January 29, 2018

Salt Lake City Police Department

SLCPD Policy Manual

SLCPD Policy Manual

Concealed Weapon License

Revised: May 23, 2022

Department Audits and Reports

210.1 PURPOSE AND SCOPE

This policy outlines the responsibility of all Salt Lake City Police Department personnel in regard to the audits and inspections conducted by the Audit & Inspections Unit and the authority of those conducting the audit/inspection. This policy, and accompanying procedure, also sets forth the procedures to be followed by the Audit & Inspections Unit, along with procedures for requesting an audit and/or inspection.

210.1.1 DEFINITIONS

Audits - Conducted internally by the Police Department Audit & Inspections Unit. Audits shall be based on Generally Accepted Government Auditing Standards (GAGAS). Audits generally fall into one of two categories: attestation or performance/compliance audits. All audits must contain the following elements:

- Audit agenda
- Audit plan
- Audit program
- Audit report
- Work papers
- Recommendations
- Management response

Reports - An examination of a specified area or procedure that does not meet the above criteria of an audit.

Inspection - Independent and objective observation and/or documentation of a function to determine compliance with policy.

Study - Independent and objective research to provide information or data to a requesting party which may not include field work.

Inventory - Reconciliation of items.

210.2 POLICY

The mission of the Audit & Inspections Unit (AIU) is to provide quality, independent, and comprehensive audits and reviews of police operations, internal controls, and systems by trained and experienced sworn auditors. When areas for improvement are identified, recommendations are made to enhance Department operations. AIU will proactively work with Department officials to identify risks, evaluate controls, and make recommendations to promote high-quality policing and effective delivery of police services.

Salt Lake City Police Department

SLCPD Policy Manual

SLCPD Policy Manual

Department Audits and Reports

The AIU's purpose shall not be to function as an Internal Affairs Unit. That is, while Internal Affairs Units focus on maintaining professional standards by investigating allegations of misconduct, the AIU's function is to review and analyze policies, procedures, and processes within the Department. While AIU's function does include ascertaining whether policies and procedures are being followed on an organizational level, AIU shall scrutinize whether these deviations from policy or procedure are due to negligence or whether the policy or procedure itself is impractical and should be revised. Additionally, the AIU should be utilized to research nationwide best practices that may be implemented at the Salt Lake City Police Department to improve departmental functioning.

210.3 COMMENCEMENT OF AN AUDIT, INSPECTION, REPORT, OR STUDY

The AIU should formulate an Annual Audit Plan (AAP) at the beginning of each calendar year. The Department's AAP is intended to be used as a guide by AIU personnel to audit various areas within the Department. The AAP is based on a Department Risk Assessment, which includes an analysis of previous audit results, new Department policy and procedures, a review of external audits, analysis of a Command Staff survey, and interviews with key Command Staff personnel. The AAP should also include required CALEA audits and inspections, determined in conjunction with the Accreditation Supervisor.

The AAP is flexible to allow unanticipated issues to be dealt with. Should it require significant interim changes, adjustments shall be presented to Department Command Staff.

Any member of Command Staff may request an audit, inspection, report, or study. A Command Staff member wishing to have an audit, inspection, report, or study conducted must submit a written request to the Support Division Commander and AIU Lieutenant. Included in the written request will be a list of objectives for the examination (i.e., what questions should the examination seek to answer). All requests will be evaluated and scheduled by the AIU Lieutenant based on the need, workload, and availability of AIU personnel. Notwithstanding, the Chief of Police, or his or her designee, has final authority to determine audit priorities.

210.3.1 AUTHORITY

The AIU Lieutenant reports to the Support Division Commander. AIU Inspectors have no command authority over line components.

Members of the AIU function under the authority of the Chief of Police as they carry out their duties. Access will be permitted to all records, facilities, and property relevant to the assigned duties of the AIU supervisors and detectives. If an Inspector requests information that is so confidential or controversial that the advisability of its release to the Inspector is questionable in the mind of the possessor of that information, the matter will be referred to the AIU Lieutenant. If the AIU Lieutenant cannot resolve the conflict, the matter will be referred to the Support Division Commander and proceed up the chain of command as necessary. The Chief of Police will be the final authority on the subject.

210.4 GENERAL DIRECTION

The purpose of an audit/inspection is to:

Salt Lake City Police Department

SLCPD Policy Manual

SLCPD Policy Manual

Department Audits and Reports

- (a) Inform management about the detailed operation of a departmental program or function.
- (b) Assist managers in directing their resources toward the efficient accomplishment of their Unit's objectives and the Department's goals.
- (c) Make recommendations to eliminate potential problems or stimulate discussion on alternative solutions to resolve problems and reduce liability issues.

AIU personnel will plan each audit at the direction of the AIU Lieutenant. As part of the audit, they will obtain and evaluate sufficient relevant material and competent evidence to determine if management and/or employees have or have not accepted and carried out the following:

- (a) Appropriate accounting procedures.
- (b) Established management or operational principles.
- (c) Pertinent policies and standards with the goal of effectively and efficiently using resources.

From information gathered and compared to pre-determined audit objectives, observations, conclusions, and recommendations will be determined and reported to the Chief of Police and affected Command Staff.

210.4.1 GENERAL GUIDELINES FOR AUDITS

- (a) A pre-agenda meeting will be held with the Commander/Administrator of the affected Bureau/Division
 - i. A risk assessment analysis will be discussed as well as items of concern the Commander/Administrator may have.
- (b) The audit plan will be submitted for approval to the AIU Lieutenant.
- (c) Inspectors will conduct the "field work" portion of the audit.
- (d) An audit program and work papers will be created and maintained by AIU.
- (e) Inspectors may conduct an exit meeting.
- (f) Once a *draft* copy of the audit is completed, it will be forwarded to the affected Commander/Administrator.
- (g) Inspectors will meet with the affected Commander/Administrator for a closing conference. Any issue of concern which cannot be reconciled in the meeting will be forwarded to the applicable Bureau Commander.
 - i. A closing conference will not be required if there are no recommendations to be discussed or if a Commander/Administrator declines.
- (h) If the audit recommends action, a formal response is required from the affected Commander/Administrator.
 - i. In the event the affected Commander/Administrator does not concur with a recommendation, discussions will be held to reach an agreement.

Salt Lake City Police Department

SLCPD Policy Manual

SLCPD Policy Manual

Department Audits and Reports

- (i) The finalized audit, along with the response, will be forwarded to the affected Bureau Commander for review and signature.
 - i. The AIU will finalize the audit, brief the Assistant Chief of Police, and submit a final copy for review and signature.
 - ii. The AIU will forward the final copy to the affected Bureau Commander for distribution.

210.4.2 GENERAL GUIDELINES FOR REPORTS, INSPECTIONS, AND STUDIES

Reports, inspections, and studies will follow the same general outline listed above for audits. However, a formal response is not required and the findings may be reported via a memorandum to the affected Commander/Administrator, applicable Bureau Commander, and the Assistant Chief of Police.

210.5 PROCEDURE

AIU personnel shall follow proper auditing and inspection procedures as outlined in the associated Department Audits and Reports Procedure.

210.6 REVISIONS

Enacted: October 30, 2018

Chapter 3 - General Operations

Use of Force

300.1 PURPOSE AND SCOPE

This policy requires that only the amount of force that reasonably appears necessary given the facts and circumstances perceived by the officer at the time may be used. While there is no way to specify the exact amount or type of reasonable force to be applied in any situation, every member of this department is expected to make such decisions in a professional, impartial and reasonable manner.

Officers have an affirmative, individual duty to ensure compliance with this policy and with all applicable municipal, state, and federal laws. Actions inconsistent with this policy may result in disciplinary action, up to and including termination. Officers whose actions are consistent with the law and provisions of this policy will be strongly supported in any subsequent review of their conduct regarding the use of force.

300.1.1 DEFINITIONS

Definitions related to this policy include:

Deadly force - Force reasonably anticipated and intended to create a substantial likelihood of causing death or serious bodily injury.

De-escalation - Taking action or communicating verbally or non-verbally during a potential force encounter in an attempt to stabilize the situation and reduce the immediacy of the threat so that more time, options, or resources can be called upon to resolve the situation without the use of force or with a reduction in the force necessary. De-escalation may include the use of such techniques as command presence, advisements, warnings, verbal persuasion, use of force continuum options, and tactical repositioning.

Feasible - Reasonably capable of being done or carried out under the circumstances to successfully achieve the arrest or lawful objective without increasing risk to the officer or another person.

Force - The application of physical techniques or tactics, chemical agents, or weapons to another person. It is not a use of force when individuals allow themselves to be searched, escorted, handcuffed, or restrained.

Imminent - Ready to take place; is distinct from immediate or instantaneous.

Necessary – Given the totality of the circumstances, an objectively reasonable officer in the same situation could conclude that force was required and that the level of force used was proportionate to the situation.

Objectively Reasonable Force - That level of force that is reasonable when analyzed from the perspective of a reasonable officer faced with the same set of facts and circumstances as the officer who actually utilized the force. The objective reasonableness of a particular use of force is

Salt Lake City Police Department

SLCPD Policy Manual

SLCPD Policy Manual

Use of Force

not analyzed in hindsight but will take into account the fact that officers must make rapid decisions regarding the amount of force to use in tense, uncertain, and rapidly evolving situations.

Reasonable Belief - Having knowledge of facts which, although not amounting to direct knowledge, could cause a reasonable officer, knowing the same facts, to reasonably come to the same conclusion.

Serious Bodily Injury - Bodily injury that creates or causes serious permanent disfigurement, protracted loss or impairment of the function of any bodily member or organ, or creates a substantial risk of death (Utah Code 76-1-601(17)).

Totality of the circumstances - All facts and circumstances known to the officer at the time, taken as a whole, including the conduct of the officer and the subject leading up to the use of force.

300.2 POLICY

The use of force by law enforcement personnel is a matter of critical concern, both to the public and to the law enforcement community. Officers are involved on a daily basis in numerous and varied interactions and, when warranted, may use reasonable force in carrying out their duties.

Officers must have an understanding of, and true appreciation for, their authority and limitations. This is especially true with respect to overcoming resistance while engaged in the performance of law enforcement duties.

The Department recognizes and respects the value of all human life and dignity without prejudice to anyone. Vesting officers with the authority to use reasonable force and to protect the public welfare requires monitoring, evaluation, and a careful balancing of all interests.

300.2.1 TACTICS PRECEDING THE USE OF FORCE

Officers should not place themselves or others in jeopardy by unreasonable, unlawful, or excessive conduct.

300.2.2 DUTY TO INTERCEDE

Any member present and observing another law enforcement officer of this or another agency using force that is clearly beyond that which is objectively reasonable under the circumstances shall, when in a position to do so, take reasonable action to interrupt the flow of events and stop the use of force.

If any member has objective information leading them to believe that another officer is going to use force that is illegal, excessive, or inconsistent with this policy, they shall intercede if feasible.

Any member who observes another law enforcement officer of this or another agency use force which is objectively unreasonable under the circumstances shall report the incident to a supervisor as soon as feasible. When observing force used by a law enforcement officer, each member should take into account the totality of the circumstances and the possibility that other law enforcement officers may have additional information regarding the threat posed by the subject.

Salt Lake City Police Department

SLCPD Policy Manual

SLCPD Policy Manual

Use of Force

If a supervisor observes such a violation, the supervisor must issue a direct order to stop the violation.

Retaliation, in any form, against another employee who intercedes in or reports a violation of the policy, or who cooperates with an investigation into a possible violation of this policy, will be subject to discipline.

300.3 USE OF FORCE

Officers shall use only that amount of force that reasonably appears necessary given the facts and circumstances perceived by the officer at the time of the event to accomplish a legitimate law enforcement purpose.

The reasonableness of force will be judged from the perspective of a reasonable officer faced with the same set of facts and circumstances. Any evaluation of reasonableness must allow for the fact that officers are often forced to make split-second decisions about the amount of force that reasonably appears necessary in a particular situation, with limited information and in circumstances that are tense, uncertain, and rapidly evolving.

Given that no policy can realistically predict every possible situation an officer might encounter, officers are entrusted to use well-reasoned discretion in determining the appropriate use of force in each incident.

It is also recognized that circumstances may arise in which officers reasonably believe that it would be impractical or ineffective to use any of the tools, weapons, or methods provided by the Department. Officers may find it more effective or reasonable to improvise their response to rapidly unfolding conditions that they are confronting. In such circumstances, the use of any improvised device or method must nonetheless be objectively reasonable and utilized only to the degree that reasonably appears necessary to accomplish a legitimate law enforcement purpose.

While the ultimate objective of every law enforcement encounter is to avoid or minimize injury, nothing in this policy requires an officer to retreat or be exposed to possible physical injury before applying reasonable force.

300.3.1 DE-ESCALATION

When circumstances reasonably permit, officers must use strategies and techniques to decrease the intensity of a situation, improve decision-making, improve communication, reduce the level of force needed, and increase voluntary compliance.

De-escalation techniques and tactics may include, but are not limited to:

- (a) attempting verbal persuasion
- (b) establishing rapport
- (c) increasing distance and time
- (d) finding, using, maintaining available cover
- (e) performing a threat assessment

Salt Lake City Police Department

SLCPD Policy Manual

SLCPD Policy Manual

Use of Force

- (f) denying access to barricaded and tactically superior positions
- (g) summoning additional resources
- (h) formulating a plan
- (i) providing accurate communications with responding personnel
- (j) tactical repositioning of resources or involved parties
- (k) providing warnings or advisements
- (l) utilizing available use of force continuum options

An officers actions, not the outcome, will serve as the basis for determining if de-escalation tactics or techniques were properly employed.

300.3.2 USE OF FORCE TO EFFECT AN ARREST

An officer may use reasonable force to effect an arrest, to prevent escape, or to overcome resistance. An officer who makes or attempts to make an arrest need not retreat or desist from the officer's efforts by reason of resistance or threatened resistance of the person being arrested; nor shall such officer be deemed the aggressor or lose the officer's right to self-defense by the use of reasonable force to effect the arrest or to prevent escape or to overcome resistance (Utah Code 77-7-7; UAC R728-507-5).

300.3.3 FACTORS USED TO DETERMINE THE REASONABLENESS OF FORCE

When determining whether to apply force and evaluating whether an officer has used reasonable force, a number of factors should be taken into consideration, as time and circumstances permit. These factors may include but are not limited to:

- (a) Immediacy and severity of the threat to officers or others.
- (b) The conduct of the individual being confronted, as reasonably perceived by the officer at the time.
- (c) Officer/subject factors (e.g., age, size, relative strength, skill level, injuries sustained, level of exhaustion or fatigue, the number of officers available vs. subjects).
- (d) The effects of suspected drug or alcohol use.
- (e) The individual's mental state or capacity.
- (f) The individual's ability to understand and comply with officer commands.
- (g) Proximity of weapons or dangerous improvised devices.
- (h) The degree to which the individual has been effectively restrained and their ability to resist despite being restrained.
- (i) The availability of other reasonable and feasible options and their possible effectiveness.
- (j) Seriousness of the suspected offense or reason for contact with the individual.
- (k) Training and experience of the officer.

Salt Lake City Police Department

SLCPD Policy Manual

SLCPD Policy Manual

Use of Force

- (l) Potential for injury to officers, suspects, and others.
- (m) Whether the individual appears to be resisting, attempting to evade arrest by flight, or is attacking the officer.
- (n) The risk and reasonably foreseeable consequences of escape.
- (o) The apparent need for immediate control of the individual or a prompt resolution of the situation.
- (p) Whether the conduct of the individual being confronted no longer reasonably appears to pose an imminent threat to the officer or others.
- (q) Prior contacts with the individual or awareness of any propensity for violence.
- (r) Any other exigent circumstances.

300.4 RESISTANCE AND CONTROL

Force situations are dynamic and require an officer to continually assess the subject's actions to ensure a proper response. Officers will transition to differing degrees or types of force as appropriate.

LEVELS OF RESISTANCE:

- A. **Cooperative** - The subject responds appropriately to the officer's presence and instructions as well as to the way the officer has taken control of the situation.
- B. **Passive Resistance** - The subject, with little or no overt physical actions, refuses to obey the officer's instructions. This behavior can be exercised by verbal objection as well as by intentional physical inertia.
- C. **Active Resistance** - The subject physically resists or physically displays their refusal to comply with the officer's order(s) without being assaultive. For example, the subject may abruptly step aside to avoid/escape the officer; they may overtly walk toward the officer, or on the contrary away from them. To run away is another example of active resistance.
- D. **Assaultive** - The subject attempts or threatens, by an act or gesture, to use force, or uses force against someone else, or leads the officer on reasonable grounds to believe that they have the ability to carry out their intentions. For example, the subject may kick or punch, or display threatening body language showing the intention to do so.
- E. **Serious Bodily Injury or Death** - The subject's behavior leads an officer to believe on reasonable grounds that they have the intention to, or is at imminent risk of, causing serious bodily injury or death to the officer or another person. For example, the subject may commit an assault with a weapon such as a knife, a bat, or a firearm, or may act in a manner likely to cause serious injuries to an officer or another person.

USE OF FORCE OPTIONS:

- A. **Officer's Presence** - As much as it is not representative of a use of force option, the mere presence of an officer can have effect on, or influence over, the subject and the situation at hand. Visible signs of authority such as an officer in uniform or a

Salt Lake City Police Department

SLCPD Policy Manual

SLCPD Policy Manual

Use of Force

marked police vehicle can have an influence on a subject, or cause them to modify their behavior.

- B. **Communication** - An officer can use both verbal and non-verbal communication to take control of a situation.
- C. **Physical Control:**
 - 1. **Soft Techniques** - Used to contain subject behaviors and are less likely to cause injury. These include immobilization techniques, escort techniques, articulation control, and pressure points.
 - 2. **Hard Techniques** - Used with the intention of preventing the continuation of a behavior, to allow the application of a control technique, and they present a higher risk of injury. These can include bare hand techniques such as punches, kicks, or grounding.
- D. **Intermediate Weapons** - This use of force option entails the use of all weapons available to an officer that are not designed, nor of a nature, to cause serious bodily injury or death to the subject. This category specifically includes impact weapons, aerosols, and conductive energy devices.
- E. **Lethal Weapons** - This use of force option includes the use of all weapons and techniques designed, or of a nature, to inflict serious bodily injury or death.

Officers have the ability to impact the direction and the outcome of many situations they handle. In their interaction with subjects, officers should use advisement, warnings, and verbal persuasion when practicable and reasonable. However, a person need not strike or attempt to strike an officer to be considered a physical threat as long as an officer has an objectively reasonable belief that the person is physically threatening and has the present ability to harm the officer or another. The department relies on the officer's judgment and discretion to employ objectively reasonable force under each unique circumstance.

300.4.1 USE OF FORCE MODEL

The attachment below is the Use of Force Model utilized by the Department. The Level of Resistance being displayed by an offender determines the Use of Force Options authorized for use by an officer. The fact that there is more than one Use of Force Option available for a given Level of Resistance does not imply that each available option must be followed in a tiered order. While each option that is available should be considered, when practicable, a subject's actions and the situation's circumstances may dictate an officer's immediate use of the highest option authorized for a given Level of Resistance.

[See attachment: Use of Force Model.pdf](#)

300.5 DEADLY FORCE APPLICATIONS

When reasonable, the officer shall, prior to the use of deadly force, make efforts to identify themselves as a peace officer and to warn that deadly force may be used, unless the officer has objectively reasonable grounds to believe the person is aware of those facts (UAC R728-507-6).

Salt Lake City Police Department

SLCPD Policy Manual

SLCPD Policy Manual

Use of Force

Use of deadly force is justified in the following circumstances (Utah Code 76-2-404; UAC R728-507-6):

- (a) An officer is justified in using deadly force when the officer reasonably believes that the use of deadly force is necessary to prevent death or serious bodily injury to the officer or another person.
- (b) An officer may use deadly force when necessary to stop a fleeing subject when the officer has probable cause to believe that the individual has committed, or intends to commit, a felony involving the infliction or threatened infliction of serious bodily injury or death, and the officer has probable cause to believe that there is an imminent risk of serious bodily injury or death to any other person if the individual is not immediately apprehended.
- (c) Under such circumstances, a verbal warning should precede the use of deadly force, where feasible.

Imminent does not mean immediate or instantaneous. An imminent danger may exist even if the suspect is not at that very moment pointing a weapon at someone.

300.5.1 SHOOTING AT A MOVING VEHICLE

Discharging a firearm at a moving vehicle is generally prohibited. An officer should only discharge a firearm at a moving vehicle or its occupants when:

- (a) The officer reasonably believes there are no other reasonable means available to avert the threat of the vehicle, and the vehicle is being used in a manner to immediately threaten the officer or another person with death or serious bodily injury; or
- (b) A person in the vehicle is threatening the officer or another person with deadly force by means other than the vehicle.

Officers should not shoot at any part of a vehicle in an attempt to disable the vehicle (UAC R728-507-6).

300.5.2 SHOOTING FROM A MOVING VEHICLE

Officers shall not discharge a firearm from a moving vehicle unless a person is immediately threatening the officer or another person with deadly force.

300.5.3 WARNING SHOTS

Warning shots are prohibited.

300.5.4 NO DEADLY FORCE IN CASES OF SELF-HARM ONLY

Under no circumstances may an officer use deadly force to prevent an individual from self-harm where the individual does not pose an imminent threat of serious bodily injury or death to the officer or others.

300.6 PHYSICAL CONTROL TECHNIQUES

Physical control techniques may be effective in controlling a passively, physically, or actively resisting individual. Officers may only apply those physical control techniques for which they

Salt Lake City Police Department

SLCPD Policy Manual

SLCPD Policy Manual

Use of Force

have successfully completed department-approved training. Officers utilizing any physical control technique should consider:

- (a) The degree to which the application of the technique may be controlled given the level of resistance.
- (b) Whether the person can comply with the direction or orders of the officer.
- (c) Whether the person has been given sufficient opportunity to comply.

The application of any physical control technique shall be discontinued once the officer determines that compliance has been achieved.

300.7 USE OF FORCE TO SEIZE EVIDENCE

When faced with a subject ingesting possible drugs or other physical evidence, officer(s) will not use physical force to remove the contraband. If a subject is suspected of placing anything in their mouth, the officer(s) should request the subject voluntarily remove the article and:

- (a) In cases when the subject is under arrest for other violations and refuses to eject the materials from their mouth, or has swallowed the material, medical personnel will be requested to evaluate the subject. The subject should be transported to the hospital for evaluation by a doctor prior to jail booking.
- (b) In cases when a subject is not under arrest, medical personnel will be requested to evaluate the subject. Every effort should be made to convince the subject to seek medical treatment if they have swallowed a substance. If they refuse medical treatment and there is no indication of physical distress, the subject should be released and a report written documenting the incident and the medical refusal.

This policy in no way prevents officers from using life-saving techniques in cases where the subject is choking and unable to breathe.

300.8 REPORTING THE USE OF FORCE

Any use of force that is Physical Control (Soft and/or Hard Techniques) or above on the Use of Force Options list is considered a reportable use of force. This does not include when a person allows themselves to be searched, escorted, handcuffed or restrained. See [Salt Lake City Police Department Procedure Manual: 320.2 REPORTABLE USES OF FORCE](#)

Any use of force defined as reportable by a member of this department shall be documented promptly, completely, and accurately in the appropriate report, depending on the nature of the incident. The officer should articulate the factors perceived and why they believed the use of force was reasonable under the circumstances.

To collect data for purposes of training, resource allocation, analysis, and related purposes, the Department may require the completion of additional report forms, as specified in department policy, procedure, or law.

An initial or supplemental report is also required whenever a member takes an action that results in, or is alleged to have resulted in, injury (minor discomfort resulting from the application and

Salt Lake City Police Department

SLCPD Policy Manual

SLCPD Policy Manual

Use of Force

general wearing of handcuffs does not, in and of itself, enact this requirement). See [Salt Lake City Police Department Procedure Manual: 320.3 REPORT REQUIREMENTS](#)

Whenever force is used, a Use of Force BlueTeam entry shall be promptly and accurately completed. One Use of Force BlueTeam entry will be completed for each subject against whom force was used. The initial officer has primary responsibility to verify that a Use of Force BlueTeam entry is completed by themselves or an assisting officer. Multiple officers involved in an incident shall not all complete a Use of Force BlueTeam entry thereby creating multiple Use of Force reports for a single subject. Any officer who used force against a subject, but is not responsible for the BlueTeam entry, shall document their actions in a narrative text.

The completion of a BlueTeam entry will be required for all reportable uses of force.

To complete a Use of Force BlueTeam entry, officers shall follow proper procedure. See [Salt Lake City Police Department Procedure Manual: 320.2 Use of Force BlueTeam Entries](#)

300.8.2 NOTIFICATION TO SUPERVISORS

Supervisory notification shall be made as soon as practicable following the application of any reportable use of force.

300.9 MEDICAL CONSIDERATIONS

Once it is reasonably safe to do so, medical assistance shall be obtained for any person who exhibits signs of physical distress, has sustained a visible injury, expresses a complaint of injury or continuing pain, or was rendered unconscious (UAC R728-507-7; UAC R728-507-11). Any individual exhibiting signs of physical distress after an encounter should be continuously monitored until they can be medically assessed. Absent exigent circumstances or direction from a medical service provider, individuals should not be placed on their stomachs for an extended period, as this could impair their ability to breathe.

Based upon the officer's initial assessment of the nature and extent of the individual's injuries, medical assistance may consist of examination by an emergency medical services provider or medical personnel at a hospital or medical personnel at the jail. If any such individual refuses medical attention, such a refusal shall be fully documented in related reports and, whenever practicable, should be witnessed by another officer and/or medical personnel. If a recording is made of the contact or an interview with the individual, any refusal should be included in the recording, if possible.

The on-scene supervisor or, if the on-scene supervisor is not available, the primary handling officer shall ensure that any person providing medical care or receiving custody of a person following any use of force is informed that the person was subjected to force. This notification shall include a description of the force used and any other circumstances the officer reasonably believes would be potential safety or medical risks to the subject (e.g., prolonged struggle, extreme agitation, impaired respiration).

Individuals who exhibit extreme agitation, violent irrational behavior accompanied by profuse sweating, extraordinary strength beyond their physical characteristics, and imperviousness to pain

Salt Lake City Police Department

SLCPD Policy Manual

SLCPD Policy Manual

Use of Force

(sometimes called "excited delirium"), or who require a protracted physical encounter with multiple officers to be brought under control, may be at an increased risk of sudden death. Calls involving these persons should be considered medical emergencies. Officers who reasonably suspect a medical emergency should request medical assistance as soon as practicable and have medical personnel stage away if appropriate. (UAC R728-507-11).

300.10 SUPERVISOR RESPONSIBILITY

When a supervisor is able to respond to an incident in which there has been a reported application of force, the supervisor is expected to:

- (a) Obtain the basic facts from the involved officers.
- (b) Ensure that any injured parties are examined and treated.
- (c) Once any initial medical assessment has been completed or first aid has been rendered, ensure that photographs have been taken of any areas involving visible injury or complaint of pain, as well as overall photographs of uninjured areas.
- (d) If an arrest review is conducted, the supervisor conducting the arrest check will be forwarded the BlueTeam Use of Force Report by the officer(s) who used force. If no arrest review was conducted, the officer(s) who used force will forward the BlueTeam Use of Force Report to a supervisor who responded to the scene. If a supervisor was unable to respond to the scene, the officer(s) who used force will forward the BlueTeam Use of Force Report to the on-duty area Sergeant. In any case, the supervisor receiving the BlueTeam Use of Force Report shall:
 1. Review the report for completeness and accuracy and either return it to the officer for corrections, or if approved, forward the report to the Internal Affairs Unit Lieutenant for release into the database.
 2. While a review of body-camera footage is always authorized, supervisors are required to review body-camera footage for use of force incidents where the subject has an obvious injury or the subject complains of injury related to the use of force incident. This review can be conducted via watching the footage on the involved officer's department-issued phone, the supervisor pairing their department-issued phone to the involved officer's body-camera, or the applicable URL if the involved officer included it in their BlueTeam Use of Force Report. The following guidelines to body-camera footage review will be followed:
 - (a) Only the amount of footage necessary to ascertain how the injury occurred is required to be reviewed.
 - (b) The review shall be noted in the portion of the BlueTeam Use of Force Report available for supervisor comments.
 - (c) The supervisor will take appropriate action in accordance with the Complaints Against Personnel and Disciplinary Action Policy, if needed.
 3. Complete the review of submitted Use of Force Reports before the end of shift.

Salt Lake City Police Department

SLCPD Policy Manual

SLCPD Policy Manual

Use of Force

- (e) The Internal Affairs Unit will review all Use of Force Reports that have been transferred from BlueTeam into IA Pro and will document the final disposition on all Use of Force Reports in IA Pro.

300.11 TRAINING

In order to ensure that the SLCPD continues to be the most professional, well trained, progressive police department in the State of Utah and beyond, officers will receive training proportionate to the desired outcomes. It is the intention of the SLCPD to provide the necessary resources to drive industry leading training initiatives, and go above and beyond the basic requirements set forth by Utah POST.

Officers will receive annual training on this policy, which will be documented by the Training Unit.

Agency personnel authorized to carry lethal and less lethal weapons will receive this policy and related instruction before authorization to carry a weapon. Policy receipt and curriculum delivery shall be documented.

Officers will receive training on physical control techniques on a biennial basis, at a minimum. This training shall be monitored by a certified tactics instructor and documented by the Training Unit.

300.12 USE OF FORCE ANALYSIS

Annually, the Administration Bureau Commander, or their designee, will prepare an analysis report on use of force incidents. The report will be submitted to the Chief of Police. The report should not contain the names of officers, suspects or case numbers, and should include:

- (a) The identification of any trends in the use of force by members (i.e., date and time of incidents; types of encounters resulting in the use of force; trends or patterns related to race, age, and gender of subjects involved; and trends or patterns resulting in injury to any person including employees).
- (b) Training needs recommendations.
- (c) Equipment needs recommendations.
- (d) Policy revision recommendations.

300.13 REVISIONS

Enacted: March 5, 2018

Revised: January 19, 2018

Revised: January 22, 2018

Revised: January 25, 2018

Revised: May 21, 2018

Revised: August 2, 2018

Revised: November 6, 2019

Revised: October 5, 2020

Salt Lake City Police Department

SLCPD Policy Manual

SLCPD Policy Manual

Use of Force

Revised: May 23, 2022

Handcuffing and Restraints

302.1 PURPOSE AND SCOPE

This policy provides guidelines for the use of handcuffs and other restraints during detentions and arrests.

302.2 POLICY

The Salt Lake City Police Department authorizes the use of restraint devices in accordance with this policy, the Use of Force Policy and department training. Restraint devices shall not be used to punish, to display authority or as a show of force.

302.3 USE OF RESTRAINTS

Only members who have successfully completed Salt Lake City Police Department-approved training on the use of restraint devices described in this policy are authorized to use these devices.

When deciding whether to use any restraint, officers should carefully balance officer safety concerns with factors that include, but are not limited to:

- The circumstances or crime leading to the arrest.
- The demeanor and behavior of the arrested person.
- The age and health of the person.
- Whether the person is known to be pregnant.
- Whether the person has a hearing or speaking disability. In such cases, consideration should be given, safety permitting, to handcuffing to the front in order to allow the person to sign or write notes.
- Whether the person has any other apparent disability.

302.3.1 RESTRAINT OF DETAINEES

Situations may arise where it may be reasonable to restrain an individual who may, after brief investigation, be released without arrest. Unless arrested, the use of restraints on detainees should continue only for as long as is reasonably necessary to assure the safety of officers and others. When deciding whether to remove restraints from a detainee, officers should continuously weigh the safety interests at hand against the continuing intrusion upon the detainee.

Juveniles should not be handcuffed to adults, nor should females be handcuffed to males.

302.3.2 RESTRAINT OF JUVENILES

A juvenile should not be restrained unless he/she is suspected of a dangerous felony or when the officer has a reasonable suspicion that the juvenile may resist, attempt escape, injure him/herself, injure the officer or damage property.

Salt Lake City Police Department

SLCPD Policy Manual

SLCPD Policy Manual

Handcuffing and Restraints

302.4 APPLICATION OF HANDCUFFS OR PLASTIC CUFFS

Handcuffs, including temporary nylon or plastic cuffs, may be used only to restrain a person's hands to ensure officer safety.

Officers should consider handcuffing any person they reasonably believe warrants that degree of restraint. However, officers should not conclude that in order to avoid risk every person should be handcuffed, regardless of the circumstances. Notwithstanding, except under extraordinary situations approved by a supervisor, no officer will permit a suspect or prisoner to enter a department vehicle without first being handcuffed.

In most situations handcuffs should be applied with the hands behind the person's back. When feasible, handcuffs should be double-locked to prevent tightening, which may cause undue discomfort or injury to the hands or wrists.

In situations where one pair of handcuffs does not appear sufficient to restrain the individual or may cause unreasonable discomfort due to the person's size, officers should consider alternatives, such as using an additional set of handcuffs or multiple plastic cuffs.

Handcuffs should be removed as soon as it is reasonable or after the person has been searched and is safely confined within a detention facility.

302.5 APPLICATION OF SPIT HOODS/MASKS/SOCKS

Spit hoods/masks/socks are temporary protective devices designed to prevent the wearer from biting and/or transferring or transmitting fluids (saliva and mucous) to others.

Spit hoods may be placed upon persons in custody when the officer reasonably believes the person will bite or spit, either on a person or in an inappropriate place. They are generally used during application of a physical restraint, while the person is restrained, or during or after transport.

Officers utilizing spit hoods should ensure that the spit hood is fastened properly to allow for adequate ventilation and that the restrained person can breathe normally. Officers should provide assistance during the movement of restrained individuals due to the potential for impaired or distorted vision on the part of the individual. Officers should avoid comingling individuals wearing spit hoods with other detainees.

Spit hoods should not be used in situations where the restrained person is bleeding profusely from the area around the mouth or nose, or if there are indications that the person has a medical condition, such as difficulty breathing or vomiting. In such cases, prompt medical care should be obtained. If the person vomits while wearing a spit hood, the spit hood should be promptly removed and discarded. Persons who have been sprayed with oleoresin capsicum (OC) spray should be thoroughly decontaminated including hair, head and clothing prior to application of a spit hood.

Those who have been placed in a spit hood should be continually monitored and shall not be left unattended until the spit hood is removed. Spit hoods shall be discarded after each use.

Salt Lake City Police Department

SLCPD Policy Manual

SLCPD Policy Manual

Handcuffing and Restraints

302.6 APPLICATION OF LEG RESTRAINT DEVICES

Leg restraints may be used to restrain the legs of a violent or potentially violent person when it is reasonable to do so during the course of detention, arrest or transportation. Only restraint devices approved by the department shall be used.

In determining whether to use the leg restraint, officers should consider:

- (a) Whether the officer or others could be exposed to injury due to the assaultive or resistant behavior of a suspect.
- (b) Whether it is reasonably necessary to protect the suspect from his/her own actions (e.g., hitting his/her head against the interior of the patrol unit, running away from the arresting officer while handcuffed, kicking at objects or officers).
- (c) Whether it is reasonably necessary to avoid damage to property (e.g., kicking at windows of the patrol unit).

302.6.1 GUIDELINES FOR USE OF LEG RESTRAINTS

When applying leg restraints the following guidelines should be followed:

- (a) Once applied, absent a medical or other emergency, restraints should remain in place until the officer arrives at the jail or other facility or the person no longer reasonably appears to pose a threat.
- (b) Once secured, the person should be placed in a seated or upright position, secured with a seat belt, and shall not be placed on his/her stomach for an extended period, as this could reduce the person's ability to breathe. Transporting face down on an ambulance gurney is permissible when attending medical personnel deem it necessary.
- (c) The restrained person should be continually monitored by an officer while in the leg restraint. The officer should ensure that the person does not roll onto and remain on his/her stomach.
- (d) The officer should look for signs of labored breathing and take appropriate steps to relieve and minimize any obvious factors contributing to this condition.
- (e) When transported by ambulance/paramedic unit, the restrained person should be accompanied by an officer when requested by medical personnel. The transporting officer should describe to medical personnel any unusual behaviors or other circumstances the officer reasonably believes would be potential safety or medical risks to the subject (e.g., prolonged struggle, extreme agitation, impaired respiration).
- (f) The leg restraints will not be used to secure prisoner's legs to fixed positions inside a vehicle as this could result in serious injury in the event of an accident.
- (g) The leg restraint device will not be affixed to the prisoner's handcuffs.
- (h) When utilizing the MJM leg restraint device, the seat belt shall be used in conjunction with the vehicle restraint system.

In addition to the above, the following guidelines should be followed when applying the WRAP restraint system:

Salt Lake City Police Department

SLCPD Policy Manual

SLCPD Policy Manual

Handcuffing and Restraints

- (a) A minimum of two officers is required to safely apply the WRAP restraint system. When possible, three officers should be utilized to maximize officer and subject safety.
- (b) Once secured in the WRAP restraint, the vest harness shall be connected to the lower restraint and adjusted such that the subject is placed in a seated or upright position. Transport in a flat position on an ambulance gurney is permissible when attending medical personnel deem it necessary.
- (c) Handcuffs may be attached to one of the WRAP restraint system's security rings if deemed necessary.
- (d) When utilizing the WRAP restraint system, the seat belt shall be used in conjunction with the WRAP restraint system.

302.7 REQUIRED DOCUMENTATION

If an individual is restrained and released without an arrest, the officer shall document the details of the detention and the need for handcuffs or other restraints in an appropriate report. The use of handcuffs in and of itself will not require a use of force report. See the Use of Force Policy for when the use of handcuffs require a use of force report.

If an individual is arrested, the use of handcuffs, and/or restraints other than handcuffs, shall be documented in the related report. A use of force report will be completed, as applicable, in compliance with the Use of Force Policy.

302.8 REVISIONS

Enacted: March 5, 2018

Revised: July 2, 2018

Revised: June 13, 2023

Control Devices and Techniques

303.1 PURPOSE AND SCOPE

This policy provides guidelines for the use and maintenance of control devices that are described in this policy.

303.2 POLICY

In order to control subjects who are violent or who demonstrate the intent to be violent, the Salt Lake City Police Department authorizes officers to use control devices in accordance with the guidelines in this policy and the Use of Force Policy.

303.3 ISSUING, CARRYING AND USING CONTROL DEVICES

Control devices described in this policy may be carried and used by members of this department only if the device has been issued by the Department or approved by the Chief of Police or the authorized designee.

Only officers who have successfully completed department-approved training in the use of any control device are authorized to carry and use the device.

Control devices may be used when a decision has been made to control, restrain or arrest a subject who is violent or who demonstrates the intent to be violent, and the use of the device appears reasonable under the circumstances. When reasonable, a verbal warning and opportunity to comply should precede the use of these devices.

When using control devices, officers should carefully consider potential impact areas in order to minimize injuries and unintentional targets.

303.4 RESPONSIBILITIES

303.4.1 QUARTERMASTER RESPONSIBILITIES

The Quartermaster shall control the inventory and issuance of all control devices and shall ensure that all issued devices meet Department standards prior to issuance, and that damaged, inoperative, outdated, or expended control devices or munitions are properly disposed of, repaired, or replaced. The exception to this is control devices maintained through the SWAT Team and/or Public Order Unit. In these cases, the Unit responsible for the applicable control device shall ensure that all issued devices meet Department standards prior to issuance, and that damaged, inoperative, outdated, or expended control devices or munitions are properly disposed of, repaired, or replaced.

303.4.2 USER RESPONSIBILITIES

All normal maintenance, charging, or cleaning shall remain the responsibility of personnel using the various devices.

Any damaged, inoperative, outdated or expended control devices or munitions shall be returned to the Quartermaster for disposition.

Salt Lake City Police Department

SLCPD Policy Manual

SLCPD Policy Manual

Control Devices and Techniques

303.5 BATON GUIDELINES

Only department-approved batons, as authorized by the Training Lieutenant, will be utilized. The Training Unit shall maintain a list of authorized batons for reference purposes. All sergeants and officers will be certified in the use of the baton and straight stick. Certification for Lieutenants and above is optional, however, certification and on-going training requirements as described below are required in order for a baton to be carried. Sergeants and officers in uniform will carry, or have readily available as an optional weapon, the baton. If an officer or sergeant in uniform chooses not to carry the baton, they must carry oleoresin capsicum (OC) spray (see the Uniform Regulations Policy for items required to carry while in detective uniform). The straight stick is only authorized for carry and use in a Mobile Field Force deployment or Public Order Unit deployment.

The need to immediately control a suspect must be weighed against the risk of causing serious injury. The head, neck, throat, spine, heart, kidneys and groin should not be intentionally targeted except when the officer reasonably believes the suspect poses an imminent threat of serious bodily injury or death to the officer or others.

303.6 TEAR GAS GUIDELINES

Tear gas may be used against barricaded suspects based on the circumstances. The use of tear gas on crowds is prohibited. Only the Watch Commander, Incident Commander, or SWAT Commander may authorize the delivery and use of tear gas, and only after evaluating all conditions known at the time and determining that such force reasonably appears justified and necessary.

The SWAT Unit maintains the Department's inventory of tear gas, as well as the specifications for the tear gas authorized for use.

When practicable, fire personnel should be alerted or summoned to the scene prior to the deployment of tear gas to control any fires and to assist in providing medical aid or gas evacuation if needed.

303.7 OLEORESIN CAPSICUM (OC) GUIDELINES

As with other control devices, oleoresin capsicum (OC) spray may be considered for use to bring under control an individual or groups of individuals who are engaging in, or are about to engage in violent behavior. OC spray should not, however, be used against individuals or groups who merely fail to disperse or do not reasonably appear to present a risk to the safety of officers or the public.

303.7.1 OC SPRAY

Only department-approved OC spray, as authorized by the Training Lieutenant, will be utilized. The Training Unit shall maintain a list of authorized OC spray devices for reference purposes. All sergeants and officers will be certified in the use of OC spray. Certification for Lieutenants and above is optional, however, certification and on-going training requirements as described below are required in order for OC spray to be carried. Sergeants and officers in uniform will carry, or have readily available as an optional weapon, OC spray. If an officer or sergeant in uniform chooses not to carry OC spray, they must carry their baton (see the Uniform Regulations Policy for items required to carry while in detective uniform).

Salt Lake City Police Department

SLCPD Policy Manual

SLCPD Policy Manual

Control Devices and Techniques

Notwithstanding the above, Airport-assigned officers shall not carry OC spray and will be required to carry their baton. Further, officers not assigned to the Airport Bureau should not use OC spray within the Airport or airplanes. This is to mitigate the possibility of closures and/or delays to Airport operations due to contamination in crowded concourses, terminals, and/or airplanes.

303.7.2 TREATMENT FOR OC SPRAY EXPOSURE

Persons who have been sprayed with or otherwise affected by the use of OC and are cooperative should be promptly provided with clean water to cleanse the affected areas by medical personnel. Subjects will not be forcibly decontaminated. If the subject is taken to jail, the officer shall notify the jail staff of the use of OC spray on the subject.

303.8 POST-APPLICATION NOTICE

Whenever tear gas or OC has been introduced into a residence, building interior, vehicle or other enclosed area, officers should provide the owners or available occupants with notice of the possible presence of residue that could result in irritation or injury if the area is not properly cleaned. Such notice should include advisement that clean up will be at the owner's expense. Information regarding the method of notice and the individuals notified should be included in related reports.

303.9 SPECIALTY IMPACT MUNITIONS (SIMS) GUIDELINES

This department is committed to reducing the potential for violent confrontations. Specialty Impact Munitions (SIMs), when used properly, are less likely to result in death or serious physical injury and can be used in an attempt to de-escalate a potentially deadly situation. All sergeants and officers will be certified in the use of SIMs. Certification for Lieutenants and above is optional, however, certification and on-going training requirements as described below are required in order for SIMs to be carried.

303.9.1 DEPLOYMENT AND USE

Only department-approved SIMs shall be carried and deployed. The Training Unit shall maintain a list of authorized SIMs and SIMs launchers for reference purposes. Approved munitions may be used to compel an individual to cease his/her actions when such munitions present a reasonable option.

Officers are not required or compelled to use approved munitions in lieu of other reasonable tactics if the involved officer determines that deployment of these munitions cannot be done safely. The safety of hostages, innocent persons and officers takes priority over the safety of subjects engaged in criminal or suicidal behavior.

Circumstances appropriate for deployment include, but are not limited to, situations in which:

- (a) The suspect is armed with a weapon and the tactical circumstances allow for the safe application of approved munitions.
- (b) The suspect has made credible threats to harm him/herself or others.

Salt Lake City Police Department

SLCPD Policy Manual

SLCPD Policy Manual

Control Devices and Techniques

- (c) The suspect is engaged in riotous behavior or is throwing rocks, bottles or other dangerous projectiles at people and/or officers.
- (d) There is probable cause to believe that the suspect has already committed a crime of violence and is refusing to comply with lawful orders.

SIMs are the only specialty munitions approved for patrol use. Only SWAT is authorized to use approved chemical munitions.

303.9.2 DEPLOYMENT CONSIDERATIONS

Before discharging projectiles, if the situation allows, the officer should consider such factors as:

- (a) Distance and angle to target.
- (b) Type of munitions employed.
- (c) Type and thickness of subject's clothing.
- (d) The subject's proximity to others.
- (e) The location of the subject.
- (f) Whether the subject's actions dictate the need for an immediate response and the use of control devices appears appropriate.

A verbal warning of the intended use of the device should precede its application, unless it would otherwise endanger the safety of officers or when it is not practicable due to the circumstances. The purpose of the warning is to give the individual a reasonable opportunity to voluntarily comply and to warn other officers and individuals that the device is being deployed.

Officers should keep in mind the manufacturer's recommendations and their training regarding effective distances and target areas. However, officers are not restricted solely to use according to manufacturer recommendations. Each situation must be evaluated on the totality of circumstances at the time of deployment.

The need to immediately incapacitate the subject must be weighed against the risk of causing serious injury or death. The head and neck should not be intentionally targeted, except when the officer reasonably believes the suspect poses an imminent threat of serious bodily injury or death to the officer or others.

303.10 LESS LETHAL SHOTGUN GUIDELINES

Less lethal shotguns, when used properly, are less likely to result in death or serious physical injury and can be used in an attempt to de-escalate a potentially deadly situation. All sergeants and officers will be certified in the use of less lethal shotguns. Certification for Lieutenants and above is optional, however, certification and on-going training requirements as described below are required in order for less lethal shotguns to be carried.

303.10.1 DEPLOYMENT AND USE

Only officers who have successfully completed department-approved training in the use of the less lethal shotgun are authorized to carry and use the device.

Salt Lake City Police Department

SLCPD Policy Manual

SLCPD Policy Manual

Control Devices and Techniques

Only department-approved less lethal shotguns and munitions shall be carried and deployed. The Training Unit shall maintain a list of authorized less lethal shotguns and munitions for reference purposes. Approved munitions may be used to compel an individual to cease their actions when such munitions present a reasonable option.

Officers are not required or compelled to use approved munitions in lieu of other reasonable tactics if the involved officer determines that deployment of these munitions cannot be done safely. The safety of hostages, innocent persons and officers takes priority over the safety of subjects engaged in criminal or suicidal behavior.

Circumstances appropriate for deployment include, but are not limited to, situations in which:

- (a) The suspect is armed with a weapon and the tactical circumstances allow for the safe application of approved munitions.
- (b) The suspect has made credible threats to harm him/herself or others.
- (c) The suspect is engaged in riotous behavior or is throwing rocks, bottles or other dangerous projectiles at people and/or officers.
- (d) There is probable cause to believe that the suspect has already committed a crime of violence and is refusing to comply with lawful orders.

Officers participating in the personally-owned lethal shotgun program shall not be issued or deploy a less lethal shotgun.

303.10.2 DEPLOYMENT CONSIDERATIONS

Before discharging projectiles, if the situation allows, the officer should consider such factors as:

- (a) Distance and angle to target.
- (b) Type of munitions employed.
- (c) Type and thickness of subject's clothing.
- (d) The subject's proximity to others.
- (e) The location of the subject.
- (f) Whether the subject's actions dictate the need for an immediate response and the use of control devices appears appropriate.

A verbal warning of the intended use of the device should precede its application, unless it would otherwise endanger the safety of officers or when it is not practicable due to the circumstances. The purpose of the warning is to:

- (a) Provide the individual with a reasonable opportunity to voluntarily comply.
- (b) Provide other officers and individuals with a warning that the device may be deployed.

The fact that a verbal or other warning was given or the reasons it was not given shall be documented by the officer deploying the less lethal shotgun in the related report.

Officers should keep in mind the manufacturer's recommendations and their training regarding effective distances and target areas. However, officers are not restricted solely to use according to

Salt Lake City Police Department

SLCPD Policy Manual

SLCPD Policy Manual

Control Devices and Techniques

manufacturer recommendations. Each situation must be evaluated on the totality of circumstances at the time of deployment.

The need to immediately incapacitate the subject must be weighed against the risk of causing serious injury or death. The head and neck should not be intentionally targeted, except when the officer reasonably believes the suspect poses an imminent threat of serious bodily injury or death to the officer or others.

303.10.3 MEDICAL CONSIDERATIONS

All persons who have been subjected to the less lethal device shall be medically assessed, as soon as practicable.

If any individual refuses medical attention, such a refusal should be witnessed by another officer and/or medical personnel and shall be fully documented in related reports.

If an individual is subjected to a less lethal device and is unable to be taken into custody to be treated, the officer deploying the device shall document the full description of the subject as well as the observed effects of the use of force in the required Use of Force report.

The transporting officer shall inform any person providing medical care or receiving custody that the individual has been subjected to the application of the less lethal device.

303.10.4 SUPERVISOR RESPONSIBILITIES

When possible, supervisors should respond to calls when they reasonably believe there is a likelihood the less lethal device may be used. A supervisor should respond to all incidents where the device was used.

A supervisor should review each incident where a person has been subjected to a less lethal device. The supervisor should ensure that proper care is given to injured officers and/or citizens. The supervisor shall notify the Watch Commander of any less lethal device deployment. The supervisor will direct any officer who deployed a less lethal device to complete all reporting requirements.

303.11 TRAINING FOR CONTROL DEVICES

The Training Lieutenant shall ensure that all personnel who are authorized to carry a control device have been properly trained and certified to carry the specific control device and are retrained or recertified as necessary.

- (a) Proficiency training shall be monitored and documented by a certified, control-device weapons or tactics instructor.
- (b) All training and proficiency for control devices will be documented by the Training Unit.
- (c) Sergeants and below will recertify annually with all approved control devices. Lieutenants and above will recertify annually with any approved control devices they desire to carry.
- (d) Officers who fail to demonstrate proficiency with the control device or knowledge of this agency's Use of Force Policy will be provided remedial training. If an officer cannot

Salt Lake City Police Department

SLCPD Policy Manual

SLCPD Policy Manual

Control Devices and Techniques

demonstrate proficiency with a control device or knowledge of this agency's Use of Force Policy after remedial training, the officer will be restricted from carrying the control device and may be subject to discipline.

303.12 CAROTID CONTROL AND CHOKE HOLDS

The use of carotid control holds, restraints, or techniques are not authorized, and officers shall not attempt to render an individual unconscious through the use of bi-lateral carotid artery restriction.

Officers are strictly prohibited from applying choke holds or direct force to the mouth, neck, or throat that will intentionally compress the airway or restrict an individual's ability to breathe unless the officer reasonably believes that the use of deadly force is necessary to prevent serious bodily injury or death to the officer or other person(s).

303.13 REPORTING USE OF CONTROL DEVICES AND TECHNIQUES

Any application of a control device or technique listed in this policy shall be documented in the related incident report and reported pursuant to the Use of Force Policy.

303.14 REVISIONS

Enacted: March 5, 2018

Revised: May 21, 2018

Revised: January 29, 2019

Revised: June 9, 2020

Revised: March 4, 2021

Conducted Energy Device

304.1 PURPOSE AND SCOPE

This policy provides guidelines for the issuance and use of CEDs.

304.2 POLICY

The TASER® device is intended to control a violent or potentially violent individual, while minimizing the risk of serious injury. The appropriate use of such a device should result in fewer serious injuries to officers and suspects.

304.3 ISSUANCE AND CARRYING CEDS

The Quartermaster shall control the inventory and issuance of all CEDs and shall ensure that all issued CEDs meet Department standards prior to issuance, and that damaged or inoperative CEDs are properly disposed of, repaired, or replaced.

Only members who have successfully completed department-approved training may be issued and carry the CED.

CEDs are issued for use during a member's current assignment. Those leaving a particular assignment may be required to return the device to the department's inventory.

All officers, sergeants, and lieutenants in uniform assignments will carry and maintain certification with the CED (see the Uniform Regulations Policy for items required to carry while in detective uniform). Maintenance of certification for Captains and above is optional, however, certification and on-going training as described below is required for a CED to be carried.

Officers shall only use the CED and cartridges that have been issued by the Department. The Training Unit shall maintain a list of authorized CEDs and cartridges for reference purposes. Uniformed officers who have been issued the CED shall wear the device in an approved holster on their person. Non-uniformed officers may secure the CED in the driver's compartment of their vehicle.

Members carrying the CED should perform a spark test on the unit prior to every shift.

When carried while in uniform, officers shall carry the CED in a manner consistent with a support hand draw.

- (a) All CEDs shall be clearly and distinctly marked to differentiate them from the duty weapon and any other device.
- (b) Officers shall be responsible for ensuring that their issued CED is properly maintained and in good working order. CEDs that are found to be malfunctioning will be returned to the Quartermaster Unit for repair or replacement.
- (c) Officers should not hold both a firearm and the CED at the same time.

Salt Lake City Police Department

SLCPD Policy Manual

SLCPD Policy Manual

Conducted Energy Device

304.4 VERBAL AND VISUAL WARNINGS

A verbal warning of the intended use of the CED should precede its application, unless it would otherwise endanger the safety of officers or when it is not practicable due to the circumstances.

The purpose of the warning is to:

- (a) Provide the individual with a reasonable opportunity to voluntarily comply.
- (b) Provide other officers and individuals with a warning that the CED may be deployed.

If, after a verbal warning, an individual is unwilling to voluntarily comply with an officer's lawful orders and it appears both reasonable and feasible under the circumstances, the officer may, but is not required to, display the electrical arc or the laser in a further attempt to gain compliance prior to the application of the CED. The aiming laser should never be intentionally directed into the eyes of another as it may permanently impair his/her vision.

The fact that a verbal or other warning was given or the reasons it was not given shall be documented by the officer deploying the CED in the related report.

304.5 USE OF THE CED

The CED has limitations and restrictions requiring consideration before its use. The CED should only be used when its operator can safely approach the subject within the operational range of the device. Although the CED can be effective in controlling individuals, officers should be aware that the device may not achieve the intended results and be prepared with other options.

304.5.1 APPLICATION OF THE EMDTDEVICE

The CED may be used in any of the following circumstances, when the circumstances perceived by the officer at the time indicate that such application is reasonably necessary to control a person:

- (a) The subject is violent or is physically resisting.
- (b) The subject has demonstrated, by words or action, an intention to be violent or to physically resist, and reasonably appears to present the potential to harm officers, him/herself or others.

Mere flight from a pursuing officer, without other known circumstances or factors, is not good cause for the use of the CED to apprehend an individual.

304.5.2 SPECIAL DEPLOYMENT CONSIDERATIONS

The use of the CED on certain individuals should generally be avoided unless the totality of the circumstances indicates that other available options reasonably appear ineffective or would present a greater danger to the officer, the subject or others, and the officer reasonably believes that the need to control the individual outweighs the risk of using the device. This includes:

- (a) Individuals who are known to be pregnant.
- (b) Elderly individuals or obvious juveniles.
- (c) Individuals with obviously low body mass.
- (d) Individuals who are handcuffed or otherwise restrained.

Salt Lake City Police Department

SLCPD Policy Manual

SLCPD Policy Manual

Conducted Energy Device

- (e) Individuals who have been recently sprayed with a flammable chemical agent or who are otherwise in close proximity to any known combustible vapor or flammable material, including alcohol-based oleoresin capsicum (OC) spray.
- (f) Individuals whose position or activity may result in collateral injury (e.g., falls from height, operating vehicles).

The CED shall not be used to psychologically torment, elicit statements or to punish any individual.

304.5.3 TARGETING CONSIDERATIONS

Reasonable efforts should be made to target lower center mass and avoid the head, neck, and groin. If the dynamics of a situation or officer safety do not permit the officer to limit the application of the CED probes to a precise target area, officers should monitor the condition of the subject if one or more probes strikes the head, neck, or groin until the subject is examined by paramedics or other medical personnel.

304.5.4 MULTIPLE APPLICATIONS OF THE CED

Officers should apply the CED for only one standard cycle and then evaluate the situation before applying any subsequent cycles.

Officers should generally not intentionally apply more than one CED at a time against a single subject.

304.5.5 ACTIONS FOLLOWING DEPLOYMENTS

Immediate action should be taken to care for the injured, to apprehend any subjects, and to protect the scene. Once the subject is restrained or has complied the CED should be turned off. Officers shall notify a supervisor of all CED discharges. A number of the confetti tags should be collected and the expended cartridge, along with both probes and wire, should be submitted into evidence. The cartridge serial number should be noted and documented on the evidence paperwork. The evidence packaging should be marked "Biohazard" if the probes penetrated the subject's skin. Photographs of probe sites should be taken.

304.5.6 DANGEROUS ANIMALS

The CED may be deployed against an animal as part of a plan to deal with a potentially dangerous animal, such as a dog, if the animal reasonably appears to pose an imminent threat to human safety or another animal, and alternative methods are not reasonably available or would likely be ineffective.

304.5.7 OFF-DUTY CONSIDERATIONS

Officers are authorized to carry department CEDs while off-duty. CEDs carried off-duty while not in uniform shall be concealed from public view.

Officers shall ensure that CEDs are secured while in their homes, vehicles or any other area under their control, in a manner that will keep the device inaccessible to others.

Salt Lake City Police Department

SLCPD Policy Manual

SLCPD Policy Manual

Conducted Energy Device

304.6 DOCUMENTATION

Officers shall document all CED discharges, if the officer aims a CED at an individual, or displays the electrical current in their reports in compliance with the Use of Force Policy (Utah Code 53-13-116: UAC R728-507-12). The notification shall also be made to a supervisor in compliance with the Use of Force Policy. Unintentional discharges will be documented in a General Offense report, with a memorandum, including the case number, sent to the officer's immediate supervisor. The memorandum will be forwarded up the chain of command to the respective officer's Division Commander.

304.6.1 REPORTS

The officer should include the following in the arrest/crime report:

- (a) Identification of all personnel firing CEDs
- (b) Medical care provided to the subject
- (c) Observations of the subject's physical and physiological actions

304.7 MEDICAL TREATMENT

Absent extenuating circumstances, only appropriate medical personnel should remove CED probes from a person's body. Used CED probes shall be treated as a sharps biohazard, similar to a used hypodermic needle, and handled appropriately. Universal precautions should be taken.

All persons who have been struck by CED probes or who have been subjected to the electric discharge of the device shall be medically assessed prior to booking. Additionally, any such individual who falls under any of the following categories should, as soon as practicable, be examined by paramedics or other qualified medical personnel:

- (a) The person is suspected of being under the influence of controlled substances and/or alcohol.
- (b) The person may be pregnant.
- (c) The person reasonably appears to be in need of medical attention.
- (d) The CED probes are lodged in a sensitive area (e.g., groin, female breast, head, face, neck).
- (e) The person requests medical treatment.

If any individual refuses medical attention, such a refusal should be witnessed by another officer and/or medical personnel and shall be fully documented in related reports.

The transporting officer shall inform any person providing medical care or receiving custody that the individual has been subjected to the application of the CED.

304.8 SUPERVISOR RESPONSIBILITIES

When possible, supervisors should respond to calls when they reasonably believe there is a likelihood the CED may be used. A supervisor should respond to all incidents where the CED was activated.

Salt Lake City Police Department

SLCPD Policy Manual

SLCPD Policy Manual

Conducted Energy Device

A supervisor should review each incident where a person has been exposed to an activation of the CED. The supervisor should ensure that proper care is given to injured officers and/or citizens. The supervisor shall notify the Watch Commander of any CED deployment. The supervisor will direct any officer who deployed a CED to have the device's onboard memory downloaded by the Training Unit as soon as practicable.

304.9 TRAINING

Personnel who are authorized to carry the CED shall be permitted to do so only after successfully completing the initial department-approved training.

The Training Lieutenant shall ensure that all personnel who are authorized to carry a CED have been properly trained and certified to carry the CED and are retrained or recertified as necessary.

- (a) Proficiency training shall occur annually and will be monitored by a certified CED instructor.
- (b) All training and proficiency for CEDs will be documented by the Training Unit.
- (c) Lieutenants and below will recertify annually with the CED. Captains and above will recertify annually with the CED if they desire to carry one.
- (d) Officers who fail to demonstrate proficiency with the CED or knowledge of this agency's Use of Force Policy will be provided remedial training. If an officer cannot demonstrate proficiency with a CED or knowledge of this agency's Use of Force Policy after remedial training, the officer will be restricted from carrying the CED and may be subject to discipline.

304.10 REVISIONS

Enacted: March 5, 2018

Revised: May 21, 2018

Revised: August 2, 2018

Revised: May 23, 2022

Officer-Involved Critical Incidents

305.1 PURPOSE AND SCOPE

The purpose of this policy is to establish policy and procedures for the investigation of an incident involving a Salt Lake City Police Department officer/employee which is considered an officer-involved critical incident as defined in UCA 76-2-408 or its successor provisions.

305.2 POLICY

The policy of the Salt Lake City Police Department is to ensure that Officer Involved Critical Incidents (OICI) are investigated in a thorough, fair and impartial manner and in accordance with State Law.

For purposes of this policy, the Department hereby adopts the definition of Officer-Involved Critical Incident as that term is defined in UCA 76-2-408 or its successor provisions.

The Salt Lake City Police Department participates and is a member of the Salt Lake County Law Enforcement Task Force: Officer Involved Critical Incident Investigative Protocol (OICI Protocol).

When an OICI Protocol qualifying event occurs with a member of the Salt Lake City Police Department, this department will invoke the OICI Protocol.

For purposes of this policy, an Involved Officer is an officer whose conduct directly results in an OICI qualifying event. A Witness Officer is an officer who witnessed the OICI but is not an Involved Officer. An Uninvolved Officer is a SLCPD officer who is neither a Witness Officer nor an Involved Officer but who otherwise is dispatched to the scene of an OICI.

305.3 TYPES OF INVESTIGATIONS

Officer Involved Critical Incidents involve several separate investigations. The investigations may include:

- (a) A criminal investigation of the suspect's actions may be conducted by an OICI Protocol Team and/or by the Salt Lake City Police Department. Generally the OICI Protocol Team will handle the criminal investigation of the suspect's actions, however, this is ultimately controlled by the agency in whose jurisdiction the suspect's crime occurred.
- (b) A criminal investigation of the Involved Officer's actions will be conducted by an OICI Protocol Team. The Salt Lake City Police Department's OICI Protocol Team shall not conduct this investigation if a Salt Lake City Officer or employee is involved. If a Salt Lake City officer or employee is involved in an OICI qualifying event outside of Salt Lake County, the agency with jurisdiction will handle the investigation. The outside agency may request that a Salt Lake County OICI Protocol Team handle the investigation; however, the Salt Lake County OICI Protocol Team may decline.
- (c) An administrative investigation as to policy compliance by Involved Officers will be conducted by the Internal Affairs Unit of the Salt Lake City Police Department regardless of where the incident occurs. The administrative investigation of each Involved Officer is controlled by the respective employing agency.

Salt Lake City Police Department

SLCPD Policy Manual

SLCPD Policy Manual

Officer-Involved Critical Incidents

305.4 INVESTIGATION PROCESS

Any evidence, including, but not limited to video recordings, audio recordings, photographs and written records that are related to an officer's use of force; regardless of whether such evidence documents the moments before or after an officer's use of force, will be collected and maintained and a copy of each turned over to the investigating OICI Protocol Team. It is the responsibility of the District Attorney's Office to make a determination as to the relevance of all collected evidence.

The administrative investigation is independent of the criminal investigation. Internal Affairs investigators will not be present during any interview or walk-through conducted by criminal investigators with the involved officer(s).

305.4.1 UNINVOLVED OFFICER RESPONSIBILITIES

Upon arrival at the scene of an OICI, the first uninvolved SLCPD officer will be the officer-in-charge until properly relieved. This officer should, as appropriate:

- (a) Secure the scene and identify and eliminate hazards for all those involved.
- (b) Take reasonable steps to obtain emergency medical attention for injured individuals.
- (c) Request additional resources from the Department or other agencies.
- (d) Coordinate a perimeter or pursuit of suspects.
- (e) Check for injured persons and evacuate as needed.
- (f) Brief the supervisor upon arrival.

305.4.2 SUPERVISOR RESPONSIBILITIES

Upon arrival at the scene, the first uninvolved SLCPD supervisor should ensure completion of the duties as outlined above, plus:

- (a) Attempt to obtain a brief overview of the situation including information contained in the "Public Safety Statement" from any Witness Officers.
 - (a) In the event that there are no Witness Officers who can supply the Public Safety Statement information, the supervisor should attempt to obtain a Public Safety Statement from the Involved Officer(s).
- (b) If necessary, the supervisor may administratively order any SLCPD officer to immediately provide a Public Safety Statement in order to secure the scene, identify injured parties and pursue suspects.
 - (a) The Public Safety Statement information shall be limited to such things as listed below:
 - (a) Type of force used - if applicable, approximate number and direction of any shots fired by the officer(s) and/or suspect(s).
 - (b) Location of injured persons, including those in need of medical attention, if any.
 - (c) Outstanding suspect information, their direction of travel and elapsed time, and description of any suspect(s) weapons.

Salt Lake City Police Department

SLCPD Policy Manual

SLCPD Policy Manual

Officer-Involved Critical Incidents

- (d) Description and location of any known evidence.
- (e) Other information as necessary to ensure officer and public safety and assist in the apprehension of any outstanding suspect(s), including the identities of all persons present.
- (b) The initial on-scene supervisor should not attempt to order any Involved Officer to provide any information other than public safety information.
- (c) It is not a requirement to record the Public Safety Statement, and at the request of the Involved Officer, it will not be recorded.
- (d) The supervisor will ensure the Public Safety Statement information is communicated to arriving supervisory personnel and the responding OICI Protocol personnel. The supervisor shall incorporate this information into his/her report.
- (c) Provide all available necessary information to the Watch Commander and Dispatch. If feasible, sensitive information should be communicated over secure networks.
- (d) Take command of and secure the incident scene with additional Salt Lake City Police Department members until properly relieved by another supervisor, other assigned personnel, an investigator, or the responding Salt Lake County OICI Protocol Team.
 - i. Salt Lake City Police Department members are responsible for securing the scene(s) throughout the duration of the OICI investigation at the direction of the Protocol Team.
 - ii. Remove unauthorized persons including police officers not required at the scene.
- (e) As soon as practicable, ensure that Involved Officers are transported (separately, if feasible) to a suitable location for further direction. The responding Protocol Team will determine the secure location where officers will be processed.
 - (a) Each involved SLCPD officer should be given an administrative order not to discuss the incident with other Involved Officers or SLCPD members pending further direction from a supervisor.
 - (b) If practicable, an officer of higher rank than the Involved Officer will escort the Involved Officer(s) and remain with them until relieved by a Protocol Team investigator. The escorting officer will not discuss the details of the incident with the Involved Officer and will document their involvement in a supplemental report.
 - (c) The condition of the Involved Officer(s) equipment and clothing must be preserved for examination by Protocol Investigators. Generally, the Involved Officer(s) will retain their weapons until a Protocol Investigator determines if the weapon(s) will be seized.
 - (d) The Involved Officer(s) weapon(s) and magazines must be examined in the loaded state by the Protocol Team. If seized, the Watch Commander will arrange for a replacement weapon and magazines as soon as possible.

Salt Lake City Police Department

SLCPD Policy Manual

SLCPD Policy Manual

Officer-Involved Critical Incidents

305.4.3 WATCH COMMANDER RESPONSIBILITIES

Upon learning of an OICI, the Watch Commander shall be responsible for coordinating all aspects of the incident until he/she is relieved by the Chief of Police, Division Commander or Investigating personnel.

305.4.4 NOTIFICATIONS

The following persons shall be notified as soon as practicable:

- Chief of Police
- Investigations Division Commander
- Salt Lake County OICI Protocol Task Force
- Internal Affairs Unit supervisor
- Peer Support personnel
- Chaplain (optional)
- Involved Officer's legal representation (if requested)
- Public Information Officer
- District Attorney (Utah Code 76-2-408)

305.4.5 INVOLVED OFFICERS

Involved Officers will be transported by an escorting officer to a secure location, where they will be processed by OICI investigators. The escorting officer will remain with the Involved Officer(s) until relieved by OICI investigators.

The Involved Officer may request an attorney. If an attorney is requested, interviews will be delayed until such time as the officer has had an opportunity to consult with the attorney. Generally, the Involved Officer will be interviewed at a later date and time by Protocol investigators.

Any Involved Officer will not be required to write a report. The reporting requirement will be satisfied by the formal interview conducted by Protocol Investigators.

The department's Protocol Liaison detective will complete the initial report. The Internal Affairs Unit will complete the Use of Force BlueTeam report.

The following shall be considered for the Involved Officer(s):

- (a) Any request for legal or union representation will be accommodated.
- (b) Discussions with agency representative/employee groups will be privileged only as to the discussion of non-criminal information.
- (c) Utah Code recognizes the sensitivity of communications with peer support team members. Peer support team members may refuse to disclose information made by a person participating in peer support services, including group therapy sessions (Utah Code 78B-5-903(3)). Peer support team members and OICI Involved Officers should be aware, however, that this only applies to communications made during

Salt Lake City Police Department

SLCPD Policy Manual

SLCPD Policy Manual

Officer-Involved Critical Incidents

individual interactions conducted by a peer support team member who is acting in the capacity of a peer support team member and functioning within the written peer support guidelines for the department (Utah Code 78B-5-903(4)) (see the Peer Support Policy). Moreover, this privilege of refusal does not apply if (Utah Code 78B-5-903(5)):

- (a) The peer support team member was a witness or a party to the incident that prompted the delivery of peer support services;
 - (b) Information received by a peer support team member is indicative of actual or suspected child abuse, or actual or suspected child neglect;
 - (c) The person receiving peer support is a clear and immediate danger to the person's self or others;
 - (d) Communication to a peer support team member establishes reasonable cause for the peer support team member to believe that the person receiving peer support services is mentally or emotionally unfit for duty; or
 - (e) Communication to the peer support team member provides evidence that the person who is receiving the peer support services has committed a crime, plans to commit a crime, or intends to conceal a crime.
- (d) Officers involved in an OICI incident will meet for a consultation with an approved licensed psychologist or licensed clinical social worker of their choice prior to their return to full duty. The consultation will be coordinated by the Peer Support Team. Documentation of attendance and the date of consultation must be provided to the officer's Division Commander prior to the officer returning for duty. All other information from the consultation is confidential between the officer and the practitioner. The initial consultation will be paid for by the City. The officer is the client for this consultation.

305.5 WITNESS IDENTIFICATION AND INTERVIEWS

Because potential witnesses to an OICI may become unavailable or the integrity of their statements compromised with the passage of time, a supervisor should take reasonable steps to promptly coordinate with the Protocol Team and criminal investigators to utilize available law enforcement personnel for the following:

- (a) Identification of all persons present at the scene and in the immediate area.
 - (a) When feasible, a recorded statement should be obtained from those persons who claim not to have witnessed the incident but were present at the time it occurred.
 - (b) Any potential witness who is unwilling or unable to remain available for a formal interview should not be detained absent reasonable suspicion to detain or probable cause to arrest. Without detaining the individual for the sole purpose of identification, attempts to identify the witness prior to his/her departure should be made whenever feasible.
- (b) Witnesses who are willing to provide a formal interview should be asked to meet at a suitable location where Protocol investigators may obtain a recorded statement. Such witnesses, if willing, may be transported by a member of the Department.

Salt Lake City Police Department

SLCPD Policy Manual

SLCPD Policy Manual

Officer-Involved Critical Incidents

305.6 INVOLVED OFFICER WEAPON PROCEDURE

The following steps shall be followed in dealing with the officer's firearm:

- (a) The Involved Officers in a shooting incident will protect their weapon(s) and magazines for examination.
- (b) The weapon(s) and magazines will be retained by the investigating Protocol Team pending completion of the District Attorney's investigation and any Judicial proceedings. The assigned department Protocol Liaison will ensure the weapon and other equipment is collected from the Protocol Team and are returned to the Quartermaster's Office or the Training Unit at the appropriate time.

305.7 ADMINISTRATIVE LEAVE

Following an Officer Involved Critical Incident, all involved officers shall be placed on administrative leave. An Involved Officer may be returned to full-duty or modified-duty only after the completion of an administrative review as further provided by this section or by decision of the Chief of Police or his/her designee following a screening presentation by the OICI Protocol team. The administrative review required by this section shall be conducted by the Chief of Police or his/her designee and all other available Deputy Chiefs following a presentation by the IA Director or his/her designee of preliminary information available to the Internal Affairs Division regarding the OICI. The administrative review shall occur no sooner than 14 days from the date the OICI protocol is invoked. This administrative review is for the sole purpose of making an initial determination regarding whether an Involved Officer will be returned to full-duty or modified-duty or will remain on administrative leave and does not constitute a determination or conclusion as to whether an officer's actions were within policy. The Chief or his/her designee retains complete discretion as to this determination.

305.8 ADMINISTRATIVE INVESTIGATION

In addition to all other investigations associated with an OICI, this department will conduct an internal administrative investigation to determine conformance with all department policy. This investigation will be conducted under the supervision of the Internal Affairs Unit.

Any Involved Officer in a shooting or death may be requested or administratively compelled to provide a blood and/or urine sample or submit to a breath test for alcohol/drug screening. Absent consent from the officer, such compelled samples and the results of any such testing shall not be disclosed to any criminal investigative agency.

Interviews of members shall be subject to department policies and applicable law.

- (a) If any officer has voluntarily elected to provide a statement to criminal investigators, the assigned administrative investigator should review that statement before proceeding with any further interview of that involved officer.
 - i. If a further interview of the officer is deemed necessary to determine policy compliance, care should be taken to limit the inquiry to new areas with minimal, if any, duplication of questions addressed in the voluntary statement. The involved officer shall be provided with a copy of his/her prior statement before proceeding with any subsequent interviews.

Salt Lake City Police Department

SLCPD Policy Manual

SLCPD Policy Manual

Officer-Involved Critical Incidents

- (b) In the event that an involved officer has elected not to provide criminal investigators with a voluntary statement, the assigned administrative investigator shall conduct an administrative interview to determine all relevant information.
 - i. Although this interview should not be unreasonably delayed, care should be taken to ensure that the officer's physical and psychological needs have been addressed before commencing the interview.
 - ii. If requested, the officer shall have the opportunity to select an uninvolved representative to be present during the interview. However, in order to maintain the integrity of each individual officer's statement, involved officers shall not consult or meet with a representative or attorney collectively or in a group prior to being interviewed.
 - iii. Administrative interviews should be recorded by the investigator. The officer may also record the interview.
 - iv. The officer shall be informed of the nature of the investigation and given his/her *Garrity* warning.
 - v. The Internal Affairs Unit shall conduct a thorough review of all available evidence to determine compliance with applicable policies.
 - vi. Any other indications of a potential violation of any policy shall be determined in accordance with applicable Department policy.

305.9 AUDIO AND VIDEO RECORDINGS

Any Involved Officer or Witness Officer in an OICI incident will be permitted to review their available body-worn camera video before making a statement.

Any body-worn camera footage shall be released according to Department policy, City policy, and state law. A copy of all body-worn camera video or other recordings shall be furnished to the OICI Protocol Team.

305.10 OICI INVOLVED OFFICER CASE REVIEW (IOCR)

The IOCR will be presented by the Investigating OICI Protocol Team to the Involved Officer(s) of any OICI, along with others listed below. This presentation will consist of the Protocol Team's case screening presentation, which was presented to the District Attorney's Office.

The IOCR will be conducted once the District Attorney has ruled on the Justification of the incident, there is no further criminal matter pending related to the incident, any Internal Affairs Investigation has been completed along with any Civilian Review Board matter, and the Involved Officer(s) have been released by the Chief of Police back to full duty (with the exception of temporary modified-duty due to injury).

This Case Review is not intended to replace any department or employee debrief. The purpose of this case review, and those who may attend, is listed below.

Involved Officer(s)

Salt Lake City Police Department

SLCPD Policy Manual

SLCPD Policy Manual

Officer-Involved Critical Incidents

- Officers present at the time the Critical Incident took place may attend the IOCR. IOCR is not intended for officers and other personnel arriving after the incident took place.
- Gives the Involved Officer(s) the opportunity to gain a greater understanding of the incident from the perspective of witnesses, investigators, and other officers.
- Gives the Involved Officer(s) the opportunity to ask any questions they may still have involving the incident in order to give them the chance to gain closure.
- Allows the officer(s) the opportunity to look for ways they can improve their response to future incidents.

Training Unit Personnel

- A representative from the Training Unit may attend; however, care should be taken to limit the number of personnel in this review in order to make the environment safe for the Involved Officer(s).
- A representative from the Training Unit may respond to the scene of any OICI, but is limited to a walk-through once the Protocol Team has completed the scene processing. By holding an IOCR and having a Training Unit representative attend, it gives the Training Unit the ability to analyze the event and look for ways to use this event in future training. This will give the Training Unit the ability to ask both the Protocol Team Investigators and the Involved Officer(s) any clarifying questions and apply it to future training scenarios.

Peer Support

- At the Involved Officer(s) request a member of Peer Support may attend in order to assist the officer(s) with Peer Support related matters.

Other Representatives

- At the Involved Officer(s) request a labor representative may attend.

305.11 MEDIA RELATIONS

Any media release shall be prepared with input and concurrence from the supervisor and department representative responsible for each phase of the investigation. Releases will be available to the Watch Commander, Investigations Division Commander and Public Information Officer (PIO) in the event of inquiries from the media.

When communicating about an Officer-Involved Critical Incident, PIOs must coordinate with the investigating authority in addition to agency investigators. The release of information pertinent to the investigation will be authorized by the investigating agency and coordinated with its PIO as well.

When on the scene of the OICI, the Watch Commander will handle media interactions and interviews about the incident, in conjunction with approval from the investigating agency (external). If no Salt Lake City Police Department PIO is available, the PIO of the investigating agency may handle media inquiries and coordinate release with their investigating officers.

Salt Lake City Police Department

SLCPD Policy Manual

SLCPD Policy Manual

Officer-Involved Critical Incidents

All release of information will adhere to the established policy on releasable information for the Salt Lake City Police Department and follow established media protocol for media interactions. Additional updates and follow-up media releases will be coordinated with Salt Lake City Police Department investigating officers, outside agency investigating officers, and outside agency PIOs.

According to protocol, the Salt Lake City Police Department will handle press releases related to OICI's involving Salt Lake City Police Department personnel as the Involved Officer.

No officer shall make any comment to the media unless he/she is authorized by the Chief of Police or their designee.

Department members receiving inquiries regarding OICI's occurring in other jurisdictions shall refrain from public comment and will direct those inquiries to the agency having jurisdiction and primary responsibility for the investigation.

305.11.1 DEPARTMENT WEBSITE

This policy shall be published on the department website along with any related written procedures and protocols (Utah Code 76-2-408).

305.12 REVISIONS

Enacted: March 5, 2018

Revised: September 7, 2018

Revised: June 29, 2020

Revised: September 14, 2022

Firearms

306.1 PURPOSE AND SCOPE

This policy provides guidelines for issuing firearms, the safe and legal carrying and use of firearms, firearms maintenance, and firearms training.

This policy does not apply to issues related to the use of firearms that are addressed in the Use of Force or Officer-Involved Shootings and Deaths policies.

This policy only applies to those members who are authorized to carry firearms.

306.2 POLICY

The Salt Lake City Police Department will equip its members with firearms to address the risks posed to the public and department members by violent and sometimes well-armed persons. The Department will ensure firearms are appropriate and in good working order and that relevant training is provided as resources allow.

Officers shall be armed with a Department-approved firearm at all times while on-duty. Division Commanders may authorize officers to be unarmed while on special assignment.

306.3 AUTHORIZED FIREARMS, AMMUNITION, AND OTHER WEAPONS

The Training Unit shall maintain a current and up to date list of all Department-approved firearms. Members shall only use firearms that are issued or approved by the Department and have been inspected by a qualified Department firearms instructor or a department-approved and designated armorer. Except in an emergency or as directed by a supervisor, no firearm shall be carried by a member who has not qualified with that firearm.

All other weapons not provided by the Department, including, but not limited to, chemical or electronic weapons, impact weapons or any weapon prohibited or restricted by law, or that is not covered elsewhere by department policy, may not be carried by members in the performance of their official duties without the express written authorization of the member's Division Commander. This exclusion does not apply to the reasonable carrying of reasonable edged weapons (e.g., pocket knife, punch dagger, fixed-blade knife).

306.3.1 HANDGUNS

The authorized department-issued handgun is the Glock Model 17 9mm. Depending on assignment and preference, officers may request the issuance of the Glock Model 19 9mm, Glock Model 26 9mm, or Glock Model 43 9mm.

Members desiring to carry an authorized but personally owned primary handgun who have been hired after October 1, 2012, are authorized to carry a Glock, Smith, and Wesson, or Walther in a 9mm striker fired platform only. Members hired before the above date are authorized to carry any of the following manufacturers in 9mm or 45 ACP.

Authorized personally-owned handguns include the following manufacturers:

Salt Lake City Police Department

SLCPD Policy Manual

SLCPD Policy Manual

Firearms

- Glock
- Smith & Wesson
- Sig Sauer
- Springfield
- Browning Hi-Power
- FN
- Heckler & Koch
- Walther
- CZ
- Colt and other approved 1911 and 2011 models

Handguns not equipped with a pistol-mounted optic are required to have night sights. Handguns equipped with an optic are not required to have night sights and it is optional.

306.3.2 SHOTGUNS

All department-owned shotguns that are issued and authorized for use will be used for less lethal purposes only. The Training Unit will maintain an updated list of approved manufacturers, models, and approved specialty munitions. Department-owned shotguns are the only shotguns authorized to be utilized in a less lethal capacity. A department-owned less lethal shotgun will only be used in the accordance with the training and directives provided to the authorized user. Refer to Less Lethal Shotgun Policy

The following personally owned shotguns are authorized to be used in a lethal capacity and may be approved for duty use:

- Remington 870, 1100 Police, and 1187 Police
- Mossberg 500, 590, 930 and ATI Tactical
- Benelli M1, M2, M3, M4, Nova, SuperNova and Vinci Tactical

Officers wishing to carry a personally owned shotgun may do so under the following conditions:

- (a) Officers must successfully complete the Basic Shotgun Certification course with the shotgun action type they intend to deploy.
- (b) Officers must attend a 4-hour recertification course and qualify annually. Officers failing to recertify or qualify with their shotgun will lose their authorization to carry the shotgun.
- (c) Shotguns must be standard production with no modifications unless the modifications have prior approval from the Training Unit.
- (d) All shotguns must be approved by the Training Unit and inspected by a qualified Department firearms instructor or a Department-approved and designated armorer prior to being carried.

Salt Lake City Police Department

SLCPD Policy Manual

SLCPD Policy Manual

Firearms

- (e) Only Department-approved or issued ammunition is authorized for duty use.
- (f) Personally owned shotguns must be equipped with ghost ring or rifle sights and a sling.

Officers participating in the personally-owned lethal shotgun program shall not be issued or deploy a less lethal shotgun.

306.3.3 PATROL RIFLE/PISTOLS

Only Training Unit-approved variants of the AR-15 family of rifles/pistols in .223/5.56 caliber will be issued and are authorized. The Training Unit will maintain an updated list of manufacturing standards that must be adhered to in order for an officer's personally owned rifle/pistol to be authorized. Officers contemplating the purchase of a rifle/pistol should consult with the Training Unit prior to making their purchase to ensure compliance with the standards. Moreover:

- (a) Rifles/pistols must be standard production with no modifications unless the modifications have prior approval by the Training Unit.
- (b) All rifles/pistols will be equipped with full or collapsible stock.
- (c) All rifles/pistols will be equipped with a minimum of two magazines.
- (d) All rifles/pistols will be equipped with either a two or three-point sling. Single-point slings are not authorized.
- (e) All rifles/pistols will be equipped with a tactical light.
- (f) Fully automatic weapons are not authorized.
- (g) Officers must attend and successfully complete the Basic Patrol Rifle Certification course as outlined by the Training Unit and approved by the Chief of Police.
- (h) Officers must attend a 4-hour recertification course and qualify annually. Officers failing to recertify or qualify with their rifle/pistol will lose their authorization to carry a rifle.
- (i) Officers failing to qualify or recertify with assigned Department-issued rifles will surrender the rifle to the Training Unit or Quartermaster.
- (j) All rifles must be approved by the Training Unit and inspected by a qualified Department firearms instructor or a Department-approved and designated armorer prior to being carried.
- (k) Only Department-approved or issued ammunition is authorized for duty use.

Members may deploy the rifle/pistol in any circumstance where the member can articulate a reasonable expectation that the rifle/pistol may be needed. Examples of some general guidelines for deploying the patrol rifle/pistol may include, but are not limited to:

- (a) Situations where the member reasonably anticipates an armed encounter.
- (b) When a member is faced with a situation that may require accurate and effective fire at long range.
- (c) Situations where a member reasonably expects the need to meet or exceed a suspect's firepower.

Salt Lake City Police Department

SLCPD Policy Manual

SLCPD Policy Manual

Firearms

- (d) When a member reasonably believes that there may be a need to fire on a barricaded person or a person with a hostage.
- (e) When a member reasonably believes that a suspect may be wearing body armor.
- (f) When authorized or requested by a supervisor.
- (g) When needed to euthanize an animal.

306.3.4 SWAT FIREARMS

Only firearms approved by Department and SWAT administration will be authorized for use by SWAT members.

All SWAT firearms will be assigned to SWAT officers with the approval of the SWAT Sergeant or Tactical Commander. All SWAT firearms must be inspected by a qualified Department firearms instructor or a Department-approved and designated armorer prior to use.

Personally owned firearms must be approved by the Tactical Commander and inspected by a qualified Department firearms instructor or a Department-approved and designated armorer prior to use.

SWAT firearms will not be assigned to personnel until they have met all qualification requirements for that firearm.

Firearm selections, accessories, ammunition, qualification courses of fire, and deployment procedures will be governed by the Salt Lake City Police Department SWAT Policy and Procedure Manual.

306.3.5 PERSONALLY OWNED DUTY FIREARMS

Personally owned duty firearms are subject to the following restrictions:

- (a) The purchase of the personally owned firearm and all required equipment shall be the responsibility of the member.
- (b) The firearm shall be in good working order and on the department list of approved firearms.
- (c) The firearm must be standard factory production with no modifications unless the modifications have prior approval from the Training Unit.
- (d) The firearm must be approved by the Training Unit and inspected by a qualified Department firearms instructor or a Department-approved and designated armorer prior to being carried, and thereafter shall be subject to inspection whenever it is deemed necessary.
- (e) Prior to carrying the firearm, members shall qualify under range supervision and thereafter shall qualify in accordance with the department qualification schedule. Members must demonstrate proficiency and safe handling, and that the firearm functions properly.
- (f) Members shall provide written notice of the make, model, serial number and caliber of the firearm to the Training Unit.

Salt Lake City Police Department

SLCPD Policy Manual

SLCPD Policy Manual

Firearms

- (g) Members shall only carry Department-authorized ammunition.
- (h) All members that carry a primary personally owned handgun will return the Department-issued handgun, as well as any Department-issued equipment for that firearm.
- (i) All members that carry a personally owned patrol rifle and/or shotgun will return a previously issued Department-owned patrol rifle and/or shotgun, as well as any Department-issued equipment for that firearm.

306.3.6 AUTHORIZED SECONDARY HANDGUN

Members desiring to carry department or personally owned secondary handguns are subject to the following restrictions:

- (a) The handgun shall be in good working order and on the department list of approved firearms.
 - i. In addition to the department list of approved handguns for primary handguns, Colt, Ruger, and Smith & Wesson small frame revolvers are authorized as secondary handguns, and shall be in either .38 Special or 9mm.
- (b) Only one secondary handgun may be carried at a time.
- (c) The purchase of the handgun shall be the responsibility of the member unless the handgun is provided by the Department.
- (d) The handgun shall be carried concealed at all times and in such a manner as to prevent unintentional cocking, discharge, or loss of physical control.
- (e) The handgun must be approved by the Training Unit and inspected by a qualified Department firearms instructor or a Department-approved and designated armorer prior to being carried and thereafter shall be subject to inspection whenever it is deemed necessary.
- (f) Members shall only carry Department-authorized ammunition. If the caliber of the handgun is other than department issue, the Chief of Police or the authorized designee shall approve the ammunition.
- (g) Prior to carrying the secondary handgun, members shall qualify under range supervision and thereafter shall qualify in accordance with the department qualification schedule. Members must demonstrate proficiency and safe handling, and that the handgun functions properly.
- (h) Members shall provide written notice of the make, model, serial number and caliber of a secondary handgun to the Training Unit.

306.3.7 AUTHORIZED OFF-DUTY FIREARMS

The carrying of firearms by members while off-duty is permitted by the Chief of Police but may be rescinded should circumstances dictate (e.g., administrative leave). Members who choose to carry a firearm while off-duty, based on their authority as peace officers, will be required to meet the following guidelines:

Salt Lake City Police Department

SLCPD Policy Manual

SLCPD Policy Manual

Firearms

- (a) A personally owned firearm shall be used, carried, and inspected in accordance with the Personally Owned Duty Firearms requirements in this policy.
 - (a) In addition to the department list of approved handguns for primary handguns, Colt, Ruger, and Smith & Wesson small frame revolvers are authorized for off-duty carry, and shall be in either .38 Special or 9mm.
 - (b) The purchase of the personally owned firearm shall be the responsibility of the member.
- (b) The firearm shall be carried concealed at all times and in such a manner as to prevent unintentional cocking, discharge or loss of physical control.
- (c) The firearm must be approved by the Training Unit and inspected by a qualified Department firearms instructor or a Department-approved and designated armorer prior to being carried and thereafter shall be subject to inspection whenever it is deemed necessary.
- (d) Prior to carrying any off-duty firearm, the member shall demonstrate to the Training Unit that he/she is proficient in handling and firing the firearm and that it will be carried in a safe manner.
- (e) The member will successfully qualify with the firearm prior to it being carried.
- (f) Members shall provide written notice of the make, model, serial number and caliber of the firearm to the Training Unit.
- (g) Members shall only carry department-authorized ammunition. If the caliber of the handgun is other than department issue, the Chief of Police or the authorized designee shall approve the ammunition.
- (h) When armed, officers shall carry their badges and Salt Lake City Police Department identification cards under circumstances requiring possession of such identification.

306.3.8 AMMUNITION

Members shall carry only department-authorized ammunition. Members shall be issued fresh duty ammunition in the specified quantity for all Department-approved firearms when deemed necessary by the Training Unit. Replacement for unserviceable or depleted ammunition issued by the Department shall be dispensed by the Training Unit when needed.

The Department will only issue 9mm, .45 caliber, and .38 Special ammunition for handguns. The Department will issue approved ammunition for rifles and shotguns.

The Training Unit shall maintain a list of authorized ammunition for reference purposes.

Ammunition for SWAT firearms will be specified and maintained by SWAT.

306.4 EQUIPMENT

Firearms carried on- or off-duty shall be maintained in a clean, serviceable condition. Maintenance and repair of authorized personally owned firearms are the responsibility of the individual member.

Salt Lake City Police Department

SLCPD Policy Manual

SLCPD Policy Manual

Firearms

306.4.1 REPAIRS OR MODIFICATIONS

Each member shall be responsible for promptly reporting any damage or malfunction of an assigned firearm to a supervisor, the Training Unit, or a Department-approved and designated armorer.

Firearms that are the property of the Department may be repaired or modified only by a person who is Department-approved and certified as an armorer or gunsmith in the repair of the specific firearm. Such modification or repair must be authorized in advance by the Training Unit.

Any repairs or modifications to the member's personally owned firearm shall be done at his/her expense and must be approved by the Training Unit.

306.4.2 HOLSTERS

Only Department-approved holsters shall be used and worn by members for duty use. Duty holsters not issued by the Quartermaster will be at a minimum level 2 retention and be carried in a safe and secure position. Members shall periodically inspect their holsters to make sure they are serviceable and provide the proper security and retention of the handgun.

306.4.3 TACTICAL LIGHTS

Tactical lights may only be installed on a firearm carried on- or off-duty after they have been examined and approved by the Training Unit, or a Department-approved and designated armorer. Once the approved tactical lights have been properly installed on any firearm, the member shall qualify with the firearm to ensure proper functionality and sighting of the firearm prior to carrying it. Members must qualify with the tactical light mounted on their firearm annually.

Officers wishing to utilize a tactical light must purchase their own tactical light, mounting hardware, and compatible duty holster, if not already provided by the Department. No tactical light/laser combinations are approved.

Officers wishing to utilize a tactical light may do so with the following requirements:

- (a) The tactical light should be mounted on the firearm at all times when carried on duty.
- (b) A flashlight must be carried in addition to the tactical light. Tactical lights should never be used in lieu of a flashlight for general illumination.
- (c) It must be reasonable for officers to deploy their firearms in order to deploy a tactical light. A flashlight should be used for illumination when deploying a firearm would not be reasonable.

306.4.4 OPTICS OR LASER SIGHTS

Optics may be installed on a rifle or shotgun after they have been examined and approved by the Training Unit or a Department-approved and designated armorer; magnification will have a minimum of one power. Any approved sight shall only be installed in accordance with manufacturer specifications. Once approved sights have been properly installed on any firearm, the member shall qualify with the firearm to ensure proper functionality and sighting of the firearm prior to carrying it. Regardless of the use of optics, all firearms must be equipped with manual sights, and no optic will replace or obstruct the use of the manual sights.

Salt Lake City Police Department

SLCPD Policy Manual

SLCPD Policy Manual

Firearms

Except in an approved training situation, a member may only sight in on a target when the member would otherwise be justified in pointing a firearm at the target.

Laser sights are not allowed.

306.4.5 PISTOL MOUNTED OPTICS

Officers that wish to participate in the Pistol Mounted Optic (PMO) program can be issued an optic ready pistol from the Quartermaster (if available) or can use their personal handgun that is capable of having an optic sight mounted from the manufacturer. Officers shall not modify their department issued Glocks to be optic ready.

Approved handguns must have raised iron sights that co-witness with the optical sight. Officers will attend a Pistol Mounted Optic (PMO) course prior to receiving approval for duty carry.

306.4.6 SUPPRESSORS

Officers authorized to carry a patrol rifle may purchase and deploy a Department-approved suppressor. The purchase of the suppressor and any associated fees and maintenance shall be the responsibility of the deploying officer. Uniform allowance shall not be used to purchase the suppressor. Officers must attend a Suppressed Weapons Transition Course and qualify with the suppressor on the rifle prior to deploying the suppressor-equipped rifle. If, after qualifying on their patrol rifle with a suppressor, an officer decides to no longer utilize a suppressor, they must requalify with the rifle without the suppressor before deploying the rifle again.

The Training Unit is the authorizing authority for patrol rifle suppressors. As such, officers contemplating the purchase of a suppressor for use with a patrol rifle should consult with the Training Unit prior to purchase in order to ensure compliance with department specifications.

The following additional standards shall be adhered to:

- (a) The suppressor must be manufactured by a reputable company and any service beyond normal maintenance must be performed by the manufacturer or their designee.
- (b) The use of quick detach devices and muzzle-brake accessories that are provided by the manufacturer for use with their product is authorized.
- (c) The rifle must operate and function reliably with the suppressor.
- (d) The suppressor must have a hearing safe manufacturing decibel rating that reduces the muzzle blast noise to below 140 db. Documentation of this shall be provided to the Training Unit prior to approval.
- (e) Suppressors shall not take the place of proper hearing protection while on the range or in training. Noise reducing ear protection is mandatory for all live-fire training. Officers are encouraged to utilize additional protection while on duty if time and circumstances allow.

Salt Lake City Police Department

SLCPD Policy Manual

SLCPD Policy Manual

Firearms

306.5 SAFE HANDLING, INSPECTION, AND STORAGE

Members shall maintain the highest level of safety when handling firearms and shall consider the following:

- (a) Members shall not unnecessarily display or handle any firearm.
- (b) Members shall be governed by all rules and regulations pertaining to the use of the range and shall obey all orders issued by the Training Unit.
- (c) Firearms shall be loaded and unloaded while pointing in a safe direction.

306.5.1 INSPECTION, DOCUMENTATION, AND STORAGE

All firearms carried on- or off-duty by officers of this Department must be kept clean and in good repair at all times. During an officer's qualification with a firearm it shall be inspected by a qualified Department firearms instructor to ensure it meets all Department requirements and is in good condition. A completed qualification card will serve as indication that the firearm was inspected. If the firearm is inspected prior to the qualification process by a Department-approved and designated armorer, written documentation of the inspection must be provided to the Department firearms instructor at the time of qualification. Any firearm found to be defective, damaged, or unsafe will be removed from service. If the firearm is the member's primary duty firearm, a replacement firearm will be issued to the member. The member will qualify with that firearm as soon as practicable.

The Quartermaster shall keep an inventory of all Department-issued firearms. Records of personally owned duty firearms will be kept via qualification cards.

Department-owned firearms shall be stored in the appropriate equipment storage room, when applicable. Members should not place or store any firearm or other weapon on Department premises except where the place of storage is locked.

Officers shall provide reasonable security measures for all firearms located within their respective workplaces and assigned vehicles.

306.5.2 STORAGE AT HOME

Members shall ensure that all firearms and ammunition are secured while in their homes, vehicles, or any other area under their control, and in a manner that will keep them inaccessible to children and others who should not have access. Officers will not leave any firearms in police vehicles overnight unless the vehicle is parked in a locked garage.

Members shall not permit Department-issued firearms to be handled by anyone not authorized by the Department to do so. Members should be aware that negligent storage of a firearm could result in civil liability.

306.5.3 ALCOHOL AND DRUGS

Firearms shall not be carried by any member, either on- or off-duty, who has consumed an amount of an alcoholic beverage, taken any drugs or medication, or has taken any combination thereof that would tend to adversely affect the member's senses or judgment.

Salt Lake City Police Department

SLCPD Policy Manual

SLCPD Policy Manual

Firearms

306.6 FIREARMS TRAINING AND QUALIFICATIONS

Every sworn officer must attend annual firearms training and demonstrate firearms safety as well as proficient weapon handling skills. Every sworn officer must qualify as directed with each Department-approved handgun carried by the officer on- or off-duty.

There will be three firearms qualifications done annually:

- Duty Qualification
- Low-Light Qualification
- Concealed Carry Qualification
- Rifle Qualification (If applicable)
- Shotgun Qualification (If applicable)

All training and qualifications for firearm proficiency shall be documented by the Training Unit. All firearms training will be monitored by an individual specified by the Training Department.

Any weapon platform that fires the 223/5.56 round will be required to qualify annually utilizing the department rifle qualification course.

306.6.1 FAILURE TO QUALIFY

Refer to the Firearms Failure to Qualify Procedure. [Salt Lake City Police Department Procedure Manual: 300.2 FAILURE TO QUALIFY](#)

306.7 FIREARM DISCHARGE

Except during training or recreational use, any member who discharges a firearm intentionally or unintentionally, on- or off-duty, shall contact their Sergeant as soon as circumstances permit. If off-duty, a member may contact any on-duty Sergeant. A notified Sergeant shall notify the Watch Commander of the incident.

In any incident involving the discharge of a firearm (except during training or recreational use) the officer shall complete an initial report for the incident, and the notified Sergeant shall complete a Firearm Discharge entry in BlueTeam. The exception to this is if the discharge took place during an Officer-Involved Critical Incident (OICI); in these cases reporting requirements in the Officer-Involved Shootings and Deaths Policy will be adhered to. In any case, the Watch Commander will ensure that Internal Affairs is notified, as well as the employee's Division Commander. The Division Commander will notify the Bureau Chief and Chief of Police as necessary.

If an officer is shot or shot at, the Watch Commander shall be notified. The Watch Commander will notify the Investigations Division for immediate follow up to the incident.

306.7.1 DESTRUCTION OF ANIMALS OR WILDLIFE

Use of force is permitted, up to and including deadly force, when an officer reasonably believes an animal poses an imminent threat to the safety of the officer, another person, or another animal. The safety of people and property must be addressed should a firearm be used to destroy an animal.

Salt Lake City Police Department

SLCPD Policy Manual

SLCPD Policy Manual

Firearms

In circumstances where officers are notified that a dangerous animal may be encountered, or when the nature of police operations increase the potential for encountering animals, officers are encouraged to develop reasonable contingencies toward a non-lethal outcome. These include, but are not limited to, requesting the assistance of Animal Control, containment, and non-lethal tools (e.g., fire extinguisher, CED, OC spray). With the exception of humanitarian destruction, such plans will be noted if the circumstances ultimately require the completion of an initial report. Nothing in this policy shall prohibit the use of a firearm if the situation dictates and/or a reasonable contingency plan has failed or becomes impractical.

Officers are authorized to use firearms in the humanitarian destruction of severely injured wildlife when the related agency is not available, or the circumstances preclude waiting an extended period of time.

306.8 FLYING WHILE ARMED

The Transportation Security Administration (TSA) has imposed rules governing law enforcement officers flying armed on commercial aircraft. The following requirements apply to officers who intend to be armed while flying on a commercial air carrier or flights where screening is conducted (49 CFR 1544.219):

- (a) Officers wishing to fly while armed must be flying in an official capacity, not for vacation or pleasure, and must have a need to have the firearm accessible, as determined by the Department based on the law and published TSA rules.
- (b) Officers must carry their Salt Lake City Police Department identification card, bearing the officer's name, a full-face photograph, identification number, the officer's signature and the signature of the Chief of Police or the official seal of the Department and must present this identification to airline officials when requested. The officer should also carry the standard photo identification needed for passenger screening by airline and TSA officials (e.g., driver license, passport).
- (c) The Salt Lake City Police Department must submit a National Law Enforcement Telecommunications System (NLETS) message prior to the officer's travel. If approved, TSA will send the Salt Lake City Police Department an NLETS message containing a unique alphanumeric identifier. The officer must present the message on the day of travel to airport personnel as authorization to travel while armed.
- (d) An official letter signed by the Chief of Police authorizing armed travel may also accompany the officer. The letter should outline the officer's need to fly armed, detail his/her itinerary, and should include that the officer has completed the mandatory TSA training for a law enforcement officer flying while armed.
- (e) Officers must have completed the mandated TSA security training covering officers flying while armed. The required training material can only be requested when there is a scheduled flight. Officers with a scheduled flight can request the training material at the following website: <https://www.tsa.gov/contact-center/form/leofa-training-materials-request>

Salt Lake City Police Department

SLCPD Policy Manual

SLCPD Policy Manual

Firearms

- (f) It is the officer's responsibility to notify the air carrier in advance of the intended armed travel. This notification should be accomplished by early check-in at the carrier's check-in counter.
- (g) Any officer flying while armed should discreetly contact the flight crew prior to take-off and notify them of his/her assigned seat.
- (h) Discretion must be used to avoid alarming passengers or crew by displaying a firearm. The officer must keep the firearm concealed on his/her person at all times. Firearms are not permitted in carry-on luggage and may not be stored in an overhead compartment.
- (i) Officers should try to resolve any problems associated with flying armed through the flight captain, ground security manager, TSA representative or other management representative of the air carrier.
- (j) Officers shall not consume alcoholic beverages while aboard an aircraft, or within eight hours prior to boarding an aircraft.

306.9 CARRYING FIREARMS OUT OF STATE

Qualified, active, full-time officers of this department are authorized to carry a concealed firearm in all other states subject to the following conditions (18 USC § 926B):

- (a) The officer shall carry his/her Salt Lake City Police Department identification card whenever carrying such firearm.
- (b) The officer is not on administrative leave due to current disciplinary investigation/action.
- (c) The officer may not be under the influence of alcohol or any other intoxicating or hallucinatory drug.
- (d) The officer will remain subject to this and all other department policies (including qualifying and training).

Officers are cautioned that individual states may enact local regulations that permit private persons or entities to prohibit or restrict the possession of concealed firearms on their property, or that prohibit or restrict the possession of firearms on any state or local government property, installation, building, base or park. Federal authority may not shield an officer from arrest and prosecution in such locally restricted areas.

Active law enforcement officers from other states are subject to all requirements set forth in 18 USC § 926B.

306.10 REVISIONS

Enacted: March 5, 2018

Revised: May 21, 2018

Revised: June 22, 2018

Revised: October 11, 2018

Salt Lake City Police Department

SLCPD Policy Manual

SLCPD Policy Manual

Firearms

Revised: February 12, 2019

Revised: October 2, 2020

Revised: March 4, 2021

Revised: April 25, 2022

Vehicle Pursuits

307.1 PURPOSE AND SCOPE

Vehicle pursuits expose innocent citizens, law enforcement officers and fleeing violators to the risk of serious injury or death. The primary purpose of this policy is to provide officers with guidance in balancing the safety of the public and themselves against law enforcement's duty to apprehend violators of the law. Another purpose of this policy is to minimize the potential for pursuit-related collisions. Vehicular pursuits require officers to exhibit a high degree of common sense and sound judgment. Officers must not forget that the immediate apprehension of a suspect is generally not more important than the safety of the public and pursuing officers.

Deciding whether to pursue a motor vehicle is a critical decision that must be made quickly and under difficult and unpredictable circumstances. In recognizing the potential risk to public safety created by vehicular pursuits, no officer or supervisor shall be criticized or disciplined for deciding not to engage in a vehicular pursuit because of the risk involved. This includes circumstances where a department policy would permit the initiation or continuation of a pursuit. It is recognized that vehicular pursuit situations are not always predictable and decisions made pursuant to this policy will be evaluated according to the totality of the circumstances reasonably available at the time of the pursuit.

Officers must remember that the most important factors in the successful conclusion of a pursuit are proper self-discipline and sound professional judgment. Officers' conduct during the course of a pursuit must be objectively reasonable (i.e., what a reasonable officer would do under the circumstances).

307.1.1 DEFINITIONS

Definitions related to this policy include (UAC R728-503-2):

Blocking or vehicle intercept - A slow-speed coordinated maneuver where two or more patrol vehicles simultaneously intercept and block the movement of a suspect vehicle, the driver of which may be unaware of the impending enforcement stop, with the goal of containment and preventing a pursuit. Blocking is not a moving or stationary roadblock.

Boxing-in - A tactic designed to stop a violator's vehicle by surrounding it with law enforcement vehicles and then slowing all vehicles to a stop.

Channelization - A technique similar to a roadblock, where objects are placed in the anticipated (or actual) path of a pursued vehicle with the intent of altering the vehicle's direction of travel.

Paralleling - Participating in the pursuit by proceeding in the same direction and maintaining approximately the same speed while traveling on an alternate street or highway that parallels the pursuit route.

Pursuit intervention - An attempt to terminate the ability of a suspect to continue to flee in a motor vehicle through tactical application of technology, road spikes, blocking, boxing, PIT (Pursuit Intervention Technique), ramming or roadblock procedures. In this context, ramming shall

Salt Lake City Police Department

SLCPD Policy Manual

SLCPD Policy Manual

Vehicle Pursuits

be construed to mean maneuvering the police vehicle into contact with the pursued vehicle to mechanically disable or forcibly position it such that further flight is not possible or practical.

Pursuit Intervention Technique (PIT) - A low-speed maneuver designed to cause the suspect vehicle to spin out and terminate the pursuit.

Ramming - When deadly force is warranted the deliberate act of impacting a violator's vehicle with another vehicle to functionally damage or otherwise force the violator's vehicle to stop.

Roadblocks - When deadly force is warranted, establishing a physical impediment to traffic as a means of stopping a vehicle using actual physical obstructions or barricades.

Tire deflating device - Tire-deflating spikes utilized to deflate the suspect vehicle's tires.

Trailing - Following the path of the pursuit at a safe speed while obeying all traffic laws and without activating emergency equipment.

Vehicle pursuit - An active attempt by an officer in an authorized emergency vehicle to stop a moving vehicle through the use of emergency equipment (i.e., emergency lights and siren) when the suspect knowingly resists apprehension by failing to stop and/or fleeing.

307.2 POLICY

It is the policy of this Department that a vehicle pursuit shall be conducted with emergency lights and siren as required by Utah Code 41-6a-212 for exemption from compliance with the rules of the road. State law does not relieve the driver of an authorized emergency vehicle from the duty to drive with due regard for the safety of all persons, nor does the law protect the driver from the consequences of an arbitrary exercise of these privileges.

This policy is not intended to set civil or criminal standards. Violations of this policy will form the basis for departmental administrative sanctions only.

307.3 OFFICER RESPONSIBILITIES

Department vehicles that do not possess operable emergency vehicle equipment and an operable police radio will not be involved in a pursuit.

A police unit containing a civilian ride-along, prisoner, family member, or any other civilian will not initiate, continue, or become involved in a pursuit, unless exigent circumstances exist or authorized by a supervisor.

307.3.1 WHEN TO INITIATE A PURSUIT

Officers will follow established Department procedure regarding when to initiate a pursuit. [Salt Lake City Police Department Procedure Manual: 310.2 WHEN TO INITIATE A PURSUIT](#)

Furthermore, factors that individually and collectively shall also be considered in deciding whether to initiate or continue a pursuit are (UAC R728-503-4):

- (a) The performance capabilities of the pursuit vehicle.
- (b) The condition of the road surface upon which the pursuit is being conducted.

Salt Lake City Police Department

SLCPD Policy Manual

SLCPD Policy Manual

Vehicle Pursuits

- (c) The amount of vehicular and pedestrian traffic in the area.
- (d) The weather conditions.
- (e) The offense for which the subject will be pursued.
- (f) Any potential or existing hazards.
- (g) Familiarity with the area and road.
- (h) Any other pertinent factors.

307.3.2 WHEN TO TERMINATE A PURSUIT

Pursuits should be discontinued whenever the totality of objective circumstances known or which reasonably ought to be known to the officer or supervisor during the pursuit indicates that the present risks of continuing the pursuit reasonably appear to outweigh the risks resulting from the suspect's escape.

Officers and supervisors must objectively and continuously weigh the seriousness of the offense against the potential danger to innocent motorists and themselves when electing to continue a pursuit. In the context of this policy, the term "terminate" shall be construed to mean discontinue or to stop chasing the fleeing vehicles.

The following factors should be considered in deciding whether to terminate a pursuit (UAC R728-503-9):

- (a) Distance between the pursuing officers and the fleeing vehicle is so great that further pursuit would be futile or require the pursuit to continue for an unreasonable time and/or distance.
- (b) Pursued vehicle's location is no longer definitely known.
- (c) Officer's pursuit vehicle sustains any type of damage that renders it unsafe to drive.
- (d) The danger posed by the continued pursuit to the public, the officers, or the suspect is greater than the value of apprehending the suspect.
- (e) Weather or traffic conditions substantially increase the danger of the pursuit beyond the benefit of apprehending the suspect.
- (f) The pursuit is terminated by a supervisor.
- (g) The officer is unfamiliar with the area and is unable to accurately notify dispatch of the location and direction of the pursuit.
- (h) The violator is driving the wrong way on a limited access highway or one-way road.
- (i) Air support is available to track the suspect.

When an officer or supervisor terminates a pursuit, the pursuing officer shall turn off the siren and emergency lights, pull the vehicle to the side of the road and stop. The officer shall not follow the suspect or attempt to maintain visual observation once the pursuit has been terminated.

Salt Lake City Police Department

SLCPD Policy Manual

SLCPD Policy Manual

Vehicle Pursuits

307.4 PURSUIT UNITS

Due to the high possibility of weapons and/or multiple suspects, four units will be used in all pursuits, when possible, to assist in a high-hazard stop at the termination point. A supervisor may approve additional units to join a pursuit if, after assessing all relevant factors, it appears that the number of officers involved would be insufficient to safely arrest the suspects. Any officer who drops out of a pursuit may, if necessary, proceed to the termination point at legal speeds, following the appropriate rules of the road. However, if officers on scene at the termination point are asking for emergency assistance, other officers may respond accordingly.

307.4.1 MOTORCYCLE OFFICERS

A distinctively marked patrol vehicle equipped with emergency overhead lighting should replace a police motorcycle as soon as practicable.

307.4.2 UNMARKED VEHICLES

All unmarked units will relinquish their role in a pursuit to a marked vehicle as soon as practicable (UAC R728-503-7).

307.4.3 CANINE UNITS

The presence of a canine unit at a pursuit termination point provides many tactical and safety advantages. Accordingly, if a canine unit is able to participate in a pursuit, and is not already engaged, the fourth unit should disengage from the pursuit to allow a canine unit's participation once a canine unit is in a position to do so. A canine unit is authorized to conduct an emergency response in order to reach the pursuit location.

307.4.4 PRIMARY UNIT RESPONSIBILITIES

The initial pursuing vehicle will be designated as the primary pursuit vehicle and will be responsible for the conduct of the pursuit unless it is unable to remain reasonably close enough to the violator's vehicle. The primary responsibility of the officer initiating the pursuit is the apprehension of the suspect(s) without unreasonable danger to themselves or other persons (UAC R728-503-7).

The pursuing officer shall activate all emergency equipment upon initiating a pursuit.

The pursuing officer shall immediately notify Dispatch that a vehicle pursuit has been initiated. Use of plain English transmissions is encouraged, rather than using the 10-code. As soon as practicable the officer shall provide Dispatch information including, but not limited to:

- (a) Unit identification.
- (b) Location, speed and direction of travel of the fleeing vehicle.
- (c) Description of the fleeing vehicle and license number, if known.
- (d) Number of known occupants.
- (e) The identity or description of the known occupants.
- (f) Reason for initiating the pursuit.

Salt Lake City Police Department

SLCPD Policy Manual

SLCPD Policy Manual

Vehicle Pursuits

- (g) Information concerning the use of firearms, threat of force, injuries, hostages or other unusual hazards.

Unless relieved by a secondary vehicle, the officer in the primary vehicle shall be responsible for the broadcasting of the progress of the pursuit. Unless practical circumstances indicate otherwise, and in order to concentrate on pursuit driving, the primary officer should relinquish the responsibility of broadcasting the progress of the pursuit to a secondary vehicle or aircraft joining the pursuit as soon as practical.

307.4.5 SECONDARY UNIT RESPONSIBILITIES

The second officer in the pursuit is responsible for the following:

- (a) The officer in the secondary vehicle should immediately notify the dispatcher of entry into the pursuit.
- (b) Remain a safe distance behind the primary vehicle unless directed to assume the role of primary officer, or if the primary vehicle is unable to continue the pursuit.
- (c) The secondary officer should be responsible for broadcasting the progress of the pursuit unless the situation indicates otherwise.

307.4.6 THIRD AND FOURTH UNIT RESPONSIBILITIES

The third and fourth officers in the pursuit are responsible for the following:

- (a) The officers in the third and fourth pursuit vehicles should immediately notify the dispatcher of entry into the pursuit.
- (b) Watch for hazards that the primary and secondary units may not observe and relay such information.
- (c) Assist in maintaining visual of the suspect vehicle.
- (d) Assist with apprehension of suspects at the termination of the pursuit.
- (e) Immediately drop out of the pursuit to handle any traffic collisions along the pursuit route.

307.4.7 PURSUIT DRIVING TACTICS

The decision to use specific driving tactics requires the same assessment of considerations outlined in the factors to be considered concerning pursuit initiation and termination. The following are tactics for units involved in the pursuit:

- (a) Officers, considering their driving skills and vehicle performance capabilities, will space themselves from other involved vehicles so they are able to see and avoid hazards or react safely to maneuvers by the fleeing vehicle.
- (b) Because intersections can present increased risks, the following tactics should be considered:
 1. Available units not directly involved in the pursuit may proceed safely to controlled intersections ahead of the pursuit in an effort to warn cross traffic.

Salt Lake City Police Department

SLCPD Policy Manual

SLCPD Policy Manual

Vehicle Pursuits

2. Pursuing units should exercise due caution when proceeding through controlled intersections.
 - (c) Officers should generally not pursue a vehicle that is driving left of center (wrong way) on a roadway.
 - (d) Officers shall have Dispatch notify the Utah Highway Patrol and/or other jurisdictional agency if it appears that the pursuit may enter their jurisdiction.
 - (e) Officers involved in a pursuit should not attempt to pass other units unless the situation indicates otherwise or they are requested to do so by the primary vehicle or a supervisor.

307.4.8 TACTICS/PROCEDURES FOR UNITS NOT INVOLVED IN THE PURSUIT

There shall be no paralleling of the pursuit route (UAC R728-503-7). Officers are authorized to use emergency equipment at intersections along the pursuit path to clear intersections of vehicular and pedestrian traffic to protect the public. Officers may position themselves in predicted areas that the pursuit may proceed through, so long as they obey all traffic laws.

The units assigned to the pursuit should be the only units operating under emergency conditions (emergency lights and siren).

307.4.9 AIRCRAFT ASSISTANCE

When available, aircraft assistance should be requested. Once the air vehicle has established visual contact with the pursued vehicle, it should relay this to Dispatch. Control of the pursuit will be retained by Salt Lake City Police Department supervisors, unless the decision is made by this department to discontinue the pursuit and another agency continues the pursuit. Pursuing units should consider the participation of aircraft assistance when determining whether to continue the pursuit.

The air vehicle should coordinate the activities of resources on the ground, report progress of the pursuit and provide officers and supervisors with details of upcoming traffic congestion, road hazards, or other pertinent information to help evaluate whether or not to continue the pursuit.

307.5 SUPERVISORY CONTROL AND RESPONSIBILITY

Available supervisory and management control will be exercised over all vehicle pursuits involving officers from this department. When reasonably possible, the supervisor shall not actually be engaged in the pursuit itself (UAC R728-503-6).

After being notified of a pursuit, a supervisor shall:

- (a) Ensure proper radio channels and procedures are in use.
- (b) Ensure tactics are in conformance with any policy of the Department.
- (c) Ensure only the necessary numbers of units are involved.
- (d) Ensure allied agencies are notified.
- (e) Consider aborting the pursuit if cause exists.

Salt Lake City Police Department

SLCPD Policy Manual

SLCPD Policy Manual

Vehicle Pursuits

- (f) Consider air support availability and practicality.
- (g) Ensure post-incident notifications.
- (h) Ensure that proper written reports are completed and forwarded to the Watch Commander (UAC R728-503-6).

The supervisor should proceed to the termination point of the pursuit and provide appropriate assistance and supervision at the scene, when practicable.

307.5.1 WATCH COMMANDER RESPONSIBILITY

Upon becoming aware that a pursuit has been initiated, the Watch Commander should monitor and continually assess the situation and ensure the pursuit is conducted within the guidelines and requirements of this policy. The Watch Commander has the final responsibility for the coordination, control and termination of a vehicle pursuit and shall be in overall command.

307.6 COMMUNICATIONS

If the pursuit is confined within the City limits, radio communications will be conducted on the primary channel unless instructed otherwise by a supervisor or communications dispatcher. If the pursuit leaves the jurisdiction of the Department or such is imminent, a supervisor should, whenever available, direct Dispatch to patch the Salt Lake City radio channel being utilized for the pursuit to an emergency channel (typically SL Regional) that is most accessible by participating agencies and units.

307.6.1 COMMUNICATIONS CENTER RESPONSIBILITIES

Upon notification that a pursuit has been initiated, Dispatch shall immediately advise a field supervisor of essential information regarding the pursuit (UAC R728-503-5).

Communications personnel also shall:

- (a) Receive and record all incoming information on the pursuit and the pursued vehicle.
- (b) Control all radio communications and clear the radio channels of all non-emergency calls.
- (c) Announce on all frequencies that a pursuit has been initiated and designate the assigned channel.
- (d) If the reason for the pursuit is not known, immediately attempt to ascertain the reason and relay it.
- (e) Perform relevant record and motor vehicle checks.
- (f) Coordinate and dispatch back-up assistance and air support units under the direction of the field supervisor.
- (g) Notify concurrent and neighboring jurisdictions, where practicable, when the pursuit may extend into their location and specify whether involvement is needed.
- (h) If the pursuit enters a bordering state, that jurisdiction should be notified.

Salt Lake City Police Department

SLCPD Policy Manual

SLCPD Policy Manual

Vehicle Pursuits

307.6.2 LOSS OF PURSUED VEHICLE

When the pursued vehicle is lost, the primary vehicle should broadcast pertinent information to assist other units in locating suspects. The primary vehicle will be responsible for coordinating any further search for either the pursued vehicle or suspects fleeing on foot.

307.7 INTER-JURISDICTIONAL CONSIDERATIONS

The primary unit shall notify communications when it is likely that a pursuit will continue into a neighboring jurisdiction or across the county or state line (UAC R728-503-8). When a pursuit enters another agency's jurisdiction, the primary officer or supervisor, taking into consideration distance traveled, unfamiliarity with the area, and other pertinent facts, should determine whether or not to request the other agency to assume the pursuit. Unless entry into another jurisdiction is expected to be brief, it is generally recommended that the primary officer or supervisor ensure that notification is provided to each outside jurisdiction into which the pursuit is reasonably expected to enter, regardless of whether or not such jurisdiction is expected to assist.

307.7.1 ASSUMPTION OF PURSUIT BY ANOTHER AGENCY

Units originally involved may relinquish control of the pursuit to another agency when the pursuit has traveled into their jurisdiction if the pursuing officers are unfamiliar with the area. Upon relinquishing control of the pursuit, the primary vehicle may proceed to the termination point to assist in the investigation.

The role and responsibilities of officers at the termination of a pursuit initiated by this department shall be coordinated with appropriate consideration of the units from the agency assuming the pursuit.

Notification of a pursuit in progress should not be construed as a request to join the pursuit. Requests to or from another agency to assume a pursuit should be specific.

307.7.2 PURSUITS EXTENDING INTO THIS JURISDICTION

The agency that initiates a pursuit shall be responsible for conducting the pursuit. Units from this department will not join a pursuit unless specifically requested to do so by the agency whose officers are in pursuit, and only when a single vehicle from the initiating agency is in pursuit. Under this circumstance, a vehicle from this department may join the pursuit until sufficient units from the initiating agency join the pursuit. The Watch Commander, or a sworn supervisor, will determine how many vehicles from this department will assist the pursuing agency.

Assistance to a pursuing allied agency by officers of the Department will terminate at the City limits provided that the pursuing officers have sufficient assistance from other sources. Ongoing participation from this department may continue only until sufficient assistance is present.

In the event that a pursuit from another agency terminates within this jurisdiction, officers shall provide appropriate assistance to officers from the allied agency including, but not limited to, scene control, coordination and completion of supplemental reports and any other assistance requested or needed.

Salt Lake City Police Department

SLCPD Policy Manual

SLCPD Policy Manual

Vehicle Pursuits

When a request is made for this department to take over a pursuit from another agency that has entered this jurisdiction, the Watch Commander will be notified and should consider:

- (a) The department's ability to maintain the pursuit.
- (b) Whether the circumstances are serious enough to continue the pursuit.
- (c) Whether there is adequate staffing to continue the pursuit.
- (d) The public's safety within this jurisdiction.
- (e) The safety of the pursuing officers.
- (f) Whether the justification for the pursuit conforms to this department's policy.

As soon as practicable, the Watch Commander should review a request from another agency to assume a pursuit. The Watch Commander, after consideration of the above factors, may decline to assume the other agency's pursuit.

307.8 PURSUIT INTERVENTION

Intervention techniques shall be used only when the officer reasonably believes it is possible to do so safely and when the law enforcement officers using them have received training in their use (UAC R728-503-7). Use of pursuit intervention tactics should be employed only after approval of a supervisor. In deciding whether to use intervention tactics, officers/supervisors should balance the risks of allowing the pursuit to continue with the potential hazards arising from the use of each tactic to the public, the officers and persons in or on the pursued vehicle. With these risks in mind, the decision to use any intervention tactic should be reasonable in light of the circumstances confronting the officer at the time of the decision.

Any pursuit intervention tactic, depending upon the conditions and circumstances under which it is used, may present dangers to the officers, the public, or anyone in or on the vehicle being pursued. Certain applications of intervention tactics may be construed to be a use of deadly force and subject to the requirements for such use. Officers who have not received department-approved training in the application and use of any intervention tactic or equipment shall consider these facts and requirements prior to deciding how, when, where, and if an intervention tactic should be employed.

Proper procedures shall be followed for all intervention techniques.

[Salt Lake City Police Department Procedure Manual: 310.3 PURSUIT INTERVENTION TECHNIQUE](#)

[Salt Lake City Police Department Procedure Manual: 310.4 STOP STICKS](#)

[Salt Lake City Police Department Procedure Manual: 310.5 RAMMING](#)

[Salt Lake City Police Department Procedure Manual: 310.6 ROADBLOCKS](#)

[Salt Lake City Police Department Procedure Manual: 310.7 CHANNELIZATION](#)

[Salt Lake City Police Department Procedure Manual: 310.8 BOXING-IN](#)

Salt Lake City Police Department

SLCPD Policy Manual

SLCPD Policy Manual

Vehicle Pursuits

307.8.1 USE OF FIREARMS

An officer's discharge of a firearm at or from a moving vehicle shall follow this department's Use of Force Policy.

307.8.2 CAPTURE OF SUSPECTS

Proper self-discipline and sound professional judgment are the keys to a successful conclusion of a pursuit and apprehension of evading suspects. Officers shall use only that amount of force which reasonably appears necessary under the circumstances to properly perform their lawful duties.

Unless relieved by a supervisor, the primary officer should coordinate efforts to apprehend the suspects following the pursuit. Officers should consider safety of the public and the involved officers when formulating plans to contain and capture the suspect(s). Accepted high-hazard stop procedures will be employed when suspects remain in the vehicle.

307.9 REPORTING AND REVIEW REQUIREMENTS

The primary officer shall complete the appropriate crime/arrest reports. A pursuit report should minimally contain:

- (a) Whether any person involved in the pursuit or subsequent arrest was injured, specifying the nature of that injury and differentiating between the suspect driver, a suspect passenger and the officers involved.
- (b) The violation that caused the pursuit to be initiated.
- (c) The identity of the officers involved in the pursuit.
- (d) The means or methods used to stop the suspect being pursued.
- (e) The charges filed against the offender(s).
- (f) The conditions of the pursuit, including, but not limited to, all of the following:
 1. Duration
 2. Approximate mileage
 3. Number of officers involved
 4. Maximum number of units involved
 5. Time of day
 6. Weather conditions
 7. Maximum speeds
- (g) Whether the pursuit resulted in a collision and a resulting injury or fatality to an uninvolved third party, and the corresponding number of persons involved.
- (h) Whether the pursuit involved multiple agencies.
- (i) How the pursuit was terminated.

All officers involved in the pursuit in any way (except the initial officer, who will complete an initial report) shall complete a supplemental report.

Salt Lake City Police Department

SLCPD Policy Manual

SLCPD Policy Manual

Vehicle Pursuits

Additional required reports and notifications shall be completed as outlined in department procedure. [Salt Lake City Police Department Procedure Manual: 310.9 REQUIRED PURSUIT REPORTS AND NOTIFICATIONS](#)

307.9.1 REGULAR AND PERIODIC PURSUIT TRAINING

Officers shall not engage in a pursuit until they have successfully completed the department-sponsored Emergency Vehicle Operations (EVO) course.

All department officers shall retain a current copy of the pursuit policy and associated procedure and shall refer to it as a basis for initiation, continuation, and termination of a pursuit (Utah Code 41-6a-212).

307.9.2 POLICY REVIEW

Each sworn employee of the Department shall certify that he/she has received, read, and understands this policy initially and upon any amendments. A documented review of this policy will occur annually for all sworn employees.

307.10 ANNUAL PURSUIT ANALYSIS

An annual analysis of pursuit reports, to include a review of policy and reporting procedures, will be conducted by the Administrative Bureau Deputy Chief, or his/her designee. The purpose of the analysis is to monitor trends that indicate training needs, modifications, and/or the addition or removal of applicable equipment. The analysis shall be submitted to the Chief of Police for review and approval.

307.11 REVISIONS

Enacted: March 5, 2018

Revised: May 21, 2018

Revised: December 7, 2018

Revised: April 6, 2021

Officer Response to Calls

308.1 PURPOSE AND SCOPE

This policy provides for the safe and appropriate response to emergency and non-emergency situations.

308.1.1 DEFINITIONS

Emergency Calls - Calls which are critical and in-progress, where immediate police intervention is required to avert personal injury, or where prompt arrival is necessary to effect criminal apprehension.

Non-Emergency Calls - Calls for police service or reports of a crime where there is no immediate threat to the safety of persons or property.

Code-3 Response/10-39 - Response to a call utilizing both emergency lights and sirens in an authorized emergency vehicle.

308.2 POLICY

Officers should not cancel assigned backup officers, nor should officers arrive on scene without backup when the call would initially require two (2) or more officers. Officers may arrive on scene without backup when the call has been holding for a significant amount of time, it has been verified the suspect(s) have left the scene, and the officer believes it would be safe to do so. Moreover, if the situation is so dynamic that loss of life is imminent, officers may proceed to the scene without waiting for additional officers.

Though arriving on scene without a backing officer may be allowed under the circumstances listed above, officers are reminded the dynamics of any situation can rapidly change, and responding to calls with a backup officer under the circumstances listed above may still be prudent.

308.3 CODE-3 RESPONSE TO EMERGENCY CALLS

State law provides that officers are allowed to drive an authorized emergency vehicle Code-3 in response to an emergency call (Utah Code 41-6a-212).

Responding with emergency lights and siren does not relieve the officer operating an authorized emergency vehicle of the duty to act as a reasonably prudent emergency vehicle operator in like circumstances. The use of any other warning equipment without emergency lights and siren does not provide any privilege under the law. Officers shall exercise sound judgment and care with due regard for life and property when responding Code-3 to an emergency call.

Officers should only respond Code-3 when circumstances reasonably indicate an emergency response is required. Officers responding Code-3 shall notify Dispatch of the Code-3 response. Officers should also advise Dispatch of the location from which they are responding.

Officers not authorized to respond Code-3, or when the emergency ceases to exist, shall observe all traffic laws and proceed without the use of emergency lights and siren. Officers shall also stop their Code-3 response upon direction from a supervisor.

Salt Lake City Police Department

SLCPD Policy Manual

SLCPD Policy Manual

Officer Response to Calls

Traffic accidents are deemed to be medical emergencies. Injury accidents are not police emergencies and units will not respond Code-3.

308.4 SUPERVISORY RESPONSIBILITIES

Upon being notified that a Code-3 response has been initiated, the Watch Commander or the field supervisor shall verify the following:

- (a) The proper response has been initiated.
- (b) No more than those units reasonably necessary under the circumstances are involved in the response.
- (c) Affected outside jurisdictions are being notified as practical.

The field supervisor shall monitor the response until it has been stabilized or terminated and assert control by directing units into or out of the response if necessary. If, in the supervisor's judgment, the circumstances require additional units to be assigned a Code-3 response, the supervisor may do so.

It is the supervisor's responsibility to terminate a Code-3 response that, in his/her judgment is inappropriate due to the circumstances.

When making the decision to authorize a Code-3 response, the Watch Commander or the field supervisor should consider the following:

- (a) The type of call
- (b) The necessity of a timely response
- (c) Traffic and roadway conditions
- (d) The location of the responding units

308.5 FAILURE OF EMERGENCY EQUIPMENT

If the emergency equipment on a vehicle should fail to operate, the officer should terminate the Code-3 response and respond accordingly. In all cases, the officer shall notify the Watch Commander, field supervisor, or Dispatch of the equipment failure so that another vehicle may be assigned to the emergency response.

308.6 RESPONSE TO NON-EMERGENCY CALLS

Officers responding to non-emergency calls should observe all traffic laws and proceed without the use of emergency lights and siren.

In circumstances that warrant an expedited response, where an actual emergency is suspected but not yet conclusively confirmed, officers shall proceed with caution and use emergency lights and siren when/where applicable (such as when clearing an intersection). This type of response may also be applicable when an emergency response is warranted, but a tactical approach would be prudent; both for the officer(s) or any potential victim(s).

Salt Lake City Police Department

SLCPD Policy Manual

SLCPD Policy Manual

Officer Response to Calls

308.7 REVISIONS

Enacted: March 5, 2018

Canines

309.1 PURPOSE AND SCOPE

This policy establishes guidelines for the use of canines to augment law enforcement services to the community including, but not limited to, locating individuals and contraband and apprehending criminal offenders.

309.2 POLICY

It is the policy of the Salt Lake City Police Department that teams of handlers and canines meet and maintain the appropriate proficiency to effectively and reasonably carry out legitimate law enforcement objectives.

309.3 ASSIGNMENT

Canine teams should be assigned to assist and supplement the Patrol Division to function primarily in assist or cover assignments. However, they may be assigned by the Watch Commander to other functions, such as routine calls for service, based on the current operational needs.

Canine teams should generally not be assigned to handle routine matters that will take them out of service for extended periods of time and then only with the approval of the Watch Commander.

309.3.1 SELECTION OF CANINES AND TRAINING INTENT

The canine program intends to select and train single-purpose and dual-purpose canines. The various drives, energy levels, focus, temperament, and stability in diverse environments of the canine will be assessed. Candidates will be subjected to and must pass a comprehensive health examination. Ideal single-purpose canine candidates should have no history of aggression nor should the canine exhibit aggression during the testing process.

For the purpose of this policy, a single-purpose canine is a canine trained explicitly in one or any combination of the following: tracking, trailing, narcotic detection, and article search. A single-purpose canine should be trained to use a passive indication and shall not be trained to bite, nor should the canine intentionally be used as a use-of-force tool.

309.4 CANINE SUPERVISOR

The canine supervisor shall be appointed by and directly responsible to the Special Operations Division Commander or the authorized designee.

The responsibilities of the supervisor include, but are not limited to:

- (a) Reviewing all canine use reports to ensure compliance with policy and to identify training issues and other needs of the program.
- (b) Maintaining a liaison with the vendor kennel.
- (c) Maintaining a liaison with command staff and functional supervisors.
- (d) Maintaining a liaison with other agency canine coordinators.
- (e) Maintaining accurate records to document canine activities.

Salt Lake City Police Department

SLCPD Policy Manual

SLCPD Policy Manual

Canines

- (f) Recommending and overseeing the procurement of equipment and services for the teams of handlers and canines.
- (g) Scheduling all canine-related activities.
- (h) Ensuring the canine teams are scheduled for regular training to maximize their capabilities.

309.5 REQUESTS FOR CANINE TEAMS

All officers of this department are encouraged to request the use of a canine.

Canine teams are deployed city-wide and respond to requests for assistance during regular duty hours. Canine handlers should offer assistance in any situation where a canine could be effectively utilized. When available, canine officers will also assist with priority crimes-in-progress and crimes-just-occurred.

Canine teams are subject to call-out 24-hours a day. Call-outs must be approved by the Watch Commander.

Canines will not normally be deployed in situations where the handler believes that injury to the canine is imminent. Canines will not normally be deployed to apprehend (make physical contact with) subjects who are armed. Exceptions may be made by the canine handler under extraordinary circumstances. Canines will, however, be deployed to search for and locate subjects who are armed or believed to be armed.

309.5.1 OUTSIDE AGENCY REQUEST

All spontaneous requests from outside agencies for SLCPD canine assistance from outside agencies must be approved by the Watch Commander and are subject to the following:

- (a) Canine teams shall not be used for any assignment that is not consistent with this policy.
- (b) The canine handler shall have the authority to decline a request for any specific assignment they deem unsuitable.
- (c) Calling out off-duty canine teams is discouraged.
- (d) It shall be the responsibility of the canine handler to coordinate operations with agency personnel in order to minimize the risk of unintended injury.
- (e) It shall be the responsibility of the canine handler to complete all necessary reports or as directed.

When circumstances in Salt Lake City require the use of a patrol canine, officers may request assistance from outside agencies. In addition to those listed above in (a)-(e), the responding outside agency canine handler shall also operate following their own agency's canine policy.

Requests for canine assistance from outside agencies for pre-planned operations must receive approval from the canine supervisor or Special Operations Division Lieutenant.

Salt Lake City Police Department

SLCPD Policy Manual

SLCPD Policy Manual

Canines

309.5.2 PUBLIC DEMONSTRATIONS

All public requests for a canine team shall be reviewed and, if appropriate, approved by the canine supervisor prior to making any resource commitment. The canine supervisor is responsible for obtaining resources and coordinating involvement in the demonstration to include proper safety protocols. Canine handlers shall not demonstrate any apprehension work unless authorized to do so by the canine supervisor.

309.6 APPREHENSION GUIDELINES

A canine may be used to locate and apprehend a suspect if the canine handler reasonably believes that the individual has either committed, is committing, or threatening to commit any serious offense and if any of the following conditions exist:

- (a) There is a reasonable belief the suspect poses an imminent threat of violence or serious harm to the public, any officer or the handler.
- (b) The suspect is physically resisting or threatening to resist arrest and the use of a canine reasonably appears to be necessary to overcome such resistance.
- (c) The suspect is believed to be concealed in an area where entry by other than the canine would pose a threat to the safety of officers or the public.

It is recognized that situations may arise that do not fall within the provisions set forth in this policy. Such events require consideration of the totality of the circumstances and the use of an objective reasonableness standard applied to the decision to use a canine.

Absent a reasonable belief that a suspect has committed, is committing, or is threatening to commit a serious offense, mere flight from a pursuing officer, without any of the above conditions, shall not serve as the basis for the use of a canine to apprehend a suspect.

Absent a change in circumstances that present an imminent threat to officers, the canine, or the public, such canine use should be conducted on a leash or under conditions that minimize the likelihood the canine will bite or otherwise injure the individual.

A single or dual-purpose canine trained in tracking and/or trailing may be used in the investigation of any criminal offense to search for anyone believed to be involved. A canine search should be conducted in a manner that minimizes the likelihood of unintended bites or injuries.

309.6.1 PREPARATION FOR DEPLOYMENT

Prior to the use of a canine to search for or apprehend any suspect, the canine handler and/or the supervisor on scene should carefully consider all pertinent information reasonably available at the time. Canine officers will locate the officer-in-charge and obtain facts relevant to the search. The information should include, but is not limited to (UAC R728-507-9):

- (a) The nature and seriousness of the suspected offense.
- (b) Whether violence or weapons were used or are anticipated.
- (c) The degree of resistance or threatened resistance, if any, the suspect has shown.
- (d) The suspect's known or perceived age.

Salt Lake City Police Department

SLCPD Policy Manual

SLCPD Policy Manual

Canines

- (e) The potential for injury to officers or the public caused by the suspect if the canine is not utilized.
- (f) Any potential danger to the public and/or other officers at the scene if the canine is released.
- (g) The potential for the suspect to escape or flee if the canine is not utilized.
- (h) Whether there are any innocent persons, children, bystanders, or other officers contained within the area in which the canine will be deployed, and whether such persons are reasonably likely to hear and respond to canine deployment warnings.

As circumstances permit, the canine handler should make every reasonable effort to communicate and coordinate with other involved members to minimize the risk of unintended injury. The canine officer will determine the most effective way to conduct the search and will brief assisting officers.

It is the canine handler's responsibility to evaluate each situation and determine whether the use of a canine is appropriate and reasonable. The canine handler shall have the authority to decline the use of the canine whenever he/she deems deployment is unsuitable.

Canines are effective in a variety of tactical situations. A tactical (non-search) deployment is the use of a canine to apprehend or assist in the apprehension of a criminal suspect or to prevent an escape.

A supervisor who is sufficiently apprised of the situation may prohibit deploying the canine.

Unless otherwise directed by a supervisor, assisting members should take direction from the handler in order to minimize interference with the canine.

Officers should not deploy a CED on a suspect at the same time a canine is being deployed to bite the suspect unless the canine handler dictates otherwise. If an officer has already deployed a CED on a suspect and a canine is deployed on the same suspect, the officer should immediately render the CED safe. A drive stun to an area not in the immediate vicinity of where the canine is biting will not affect the canine.

309.6.2 WARNINGS AND ANNOUNCEMENTS

Unless it would increase the risk of injury or escape, a clearly audible warning announcing that a canine will be used if the suspect does not surrender should be made prior to releasing a canine. The handler should allow a reasonable time for a suspect to surrender.

309.6.3 PROCEDURE FOR FLEEING SUSPECTS

When an officer is pursuing a criminal suspect and contact with the suspect is lost, the officer should stop and pinpoint the suspect's last known location for the canine handler. Additionally, every effort should be made by the officers at the scene to:

- (a) Establish containment (Plan C) of an area if there is a high probability that the suspect is within a containable area. [Salt Lake City Police Department Procedure Manual: 400.2 PLAN "C" PROCEDURE](#) Otherwise, saturate the area with high-visibility patrol in an effort to discourage active flight by the suspect.

Salt Lake City Police Department

SLCPD Policy Manual

SLCPD Policy Manual

Canines

- (b) Avoid contaminating the area with human scent.
- (c) Protect all items holding the suspect's scent from being handled or otherwise contaminated.
- (d) Provide back-up for the canine team(s).
- (e) Collect evidence and process arrested persons located during the search.

309.6.4 REPORTING DEPLOYMENTS, BITES AND INJURIES

Whenever a canine deployment results in a bite or causes injury to an intended suspect, a supervisor and Watch Commander should be promptly notified and the deployment and injuries documented in an initial or supplemental report, as appropriate. Use of force reports must also be completed in accordance with the Use of Force Policy. The injured person shall be promptly treated by emergency medical services personnel and, if appropriate, transported to an appropriate medical facility for further treatment.

In cases where the injured person is a juvenile, the canine handler must ensure that a parent, guardian, or other responsible person is notified. A canine handler will not transport a prisoner that has been bitten by a police service dog.

Any unintended bite or injury caused by a canine, whether on- or off-duty, shall be promptly reported to the canine supervisor. Unintended bites or injuries caused by a canine should be documented in a General Offense report.

If an individual alleges an injury, either visible or not visible, a supervisor shall be notified and both the individual's injured and uninjured areas shall be photographed as soon as practicable after first tending to the immediate needs of the injured party. Photographs shall be retained as evidence in accordance with current department evidence procedures.

309.6.5 JUVENILES

A canine shall not be used to apprehend a known juvenile suspect unless they pose an imminent threat of serious bodily injury or death to the officer or another person (UAC R728-507-9).

309.7 NON_APPREHENSION GUIDELINES

Properly trained canines may be used to track or search for non-criminals (e.g., lost children, and individuals who may be disoriented or in need of medical attention). The canine handler is responsible for determining the canine's suitability for such assignments based on the conditions and the particular abilities of the canine. When the canine is deployed in a search or other non-apprehension operation, the following guidelines apply.

- (a) Absent a change in circumstances that present an immediate threat to officers, the canine, or the public, such applications should be conducted on-leash or under conditions that minimize the likelihood the canine will bite or otherwise injure the individual is located.
- (b) Unless otherwise directed by a supervisor, assisting department members should take direction from the handler in order to minimize interference with the canine.

Salt Lake City Police Department

SLCPD Policy Manual

SLCPD Policy Manual

Canines

309.7.1 ARTICLE DETECTION

A canine trained to find objects or property related to a person or crime may be used to locate or identify articles. A canine search should be conducted in a manner that minimizes the likelihood of unintended bites or injuries.

309.7.2 NARCOTICS DETECTION

Salt Lake Police drug detection dogs are available to search for the most commonly abused controlled substances. Officers requesting the assistance of a drug detection dog should avoid disturbing the search area. Such disturbance, however, will not preclude the use of a drug detection dog. A canine trained in narcotics detection may be used in accordance with current law and under certain circumstances, including:

- (a) The search of vehicles, buildings, bags, and other articles.
- (b) Assisting in the search for narcotics during a search warrant service.
- (c) Obtaining a search warrant by using the narcotics-detection trained canine in support of probable cause.

Arrested persons should be removed from the search area prior to the arrival of the canine team.

309.8 HANDLER SELECTION

The minimum qualifications for the assignment of canine handler include:

- (a) An officer who is currently off probation.
- (b) Agreeing to be assigned to the position for a minimum of five years.

309.9 HANDLER RESPONSIBILITIES

The canine handler shall ultimately be responsible for 24-hour care and maintenance of the canine and shall ensure that the canine receives proper nutrition, grooming, training, medical care, affection and living conditions.

The canine handler will be responsible for the following:

- (a) Except as required during appropriate deployment, the handler shall not expose the canine to any foreseeable and unreasonable risk of harm.
- (b) The handler shall maintain all department equipment under his/her control in a clean and serviceable condition. Required equipment includes:
 - i. Leash
 - ii. Harness
 - iii. Muzzle
 - iv. Kennel
 - v. NARCAN®
 - vi. Vet bag (with first aid ingredients)
 - vii. Other equipment as determined by the canine supervisor

Salt Lake City Police Department

SLCPD Policy Manual

SLCPD Policy Manual

Canines

- (c) Handlers shall permit the canine supervisor to conduct spontaneous on-site inspections of affected areas of their homes as well as their canine vehicles to verify that conditions and equipment conform to this policy.
- (d) Any changes in the living status of the handler that may affect the lodging or environment of the canine shall be reported to the canine supervisor as soon as possible.
- (e) The canine should be permitted to socialize in the home with the handler's family for short periods of time and under the direct supervision of the handler.
- (f) Under no circumstances will the canine be lodged at another location unless approved by the canine supervisor or Watch Commander.
- (g) When off-duty, the handler shall not involve the canine in any law enforcement activity or official conduct unless approved in advance by the canine supervisor or Watch Commander.
- (h) Whenever a canine handler is off-duty for an extended number of days, it may be necessary to temporarily relocate the canine. In those situations, the handler shall give reasonable notice to the canine supervisor so that appropriate arrangements can be made.
- (i) Canine handlers will not use a police service dog to intimidate any person outside the scope of a reasonable deployment.

309.9.1 CANINE IN PUBLIC AREAS

A single or dual-purpose canine should be kept on a leash when in areas that allow access to the public. Exceptions to this rule would include specific law enforcement operations for which the canine is trained and/or the handler may allow the canine to be off-leash when the handler feels the circumstances are appropriate.

- (a) A canine shall not be left unattended in any area to which the public may have access.
- (b) When the canine vehicle is left unattended, all windows and doors shall be secured in such a manner as to prevent unauthorized access to the dog. The handler shall also ensure that the unattended vehicle remains inhabitable for the canine.

309.10 SAFETY PROTOCOLS

Police service dogs are trained to respond to their perception of threatening behavior. Officers and employees of the Department shall conduct themselves accordingly when in the proximity of a canine. Employees will not agitate or tease a police service dog and will not approach, address or handle a canine out of the presence of the handler unless extraordinary circumstances exist. During canine deployments, the following safety protocols will be followed:

- (a) The canine handler will be focused on the dog. The assisting officer is responsible to continually scan the area for threats and hazards.
- (b) Officers will stay with the canine handler unless directed to do otherwise or exigent circumstances exist.
- (c) Assisting officers will follow the directions given by the canine handler.

Salt Lake City Police Department

SLCPD Policy Manual

SLCPD Policy Manual

Canines

- (d) In the event that the canine locates a suspect, the search team will be prepared to act at the direction of the handler. The handler will recall the dog as soon as it is safe to do so. Assisting officers will take control of the suspect at the handler's direction.
- (e) If a canine shows interest in an officer, the officer should not react or reach out to the dog. The officer should stand with normal posture and should not move.

309.10.1 INTERFERING WITH HANDLER OR CANINE

Department personnel, officers, and members of the public should be familiar with Utah Code 76-9-306 "Police service canine – Causing injury or interfering with handler". Any violations will be investigated for prosecution.

309.11 HANDLER COMPENSATION

Canine handler compensation will be in accordance with the applicable Memorandum of Understanding.

309.12 CANINE INJURY AND MEDICAL CARE

In the event that a canine is injured, or there is an indication that the canine is not in good physical condition, the injury or condition will be reported to the canine supervisor or Watch Commander as soon as practicable and appropriately documented.

All medical attention shall be rendered by the designated canine veterinarian, except during an emergency where treatment should be obtained from the nearest available veterinarian.

309.13 TRAINING

Before assignment in the field, each canine team shall be trained and certified to meet current Utah Peace Officer Standards and Training (POST) Service Dog Program requirements or other recognized and approved certification standards.

All canine training should be conducted while on-duty unless otherwise approved by the canine supervisor.

309.13.1 CONTINUED TRAINING

Each canine team shall thereafter be recertified to Utah POST Service Dog Program or other recognized and approved certification standards on an annual basis. In addition to the annual certification, canine handlers will participate in monthly in-service training that will be documented in the online canine tracking system. Additional training considerations are as follows:

- (a) Canine handlers are encouraged to engage in additional training with the approval of the canine supervisor.
- (b) To ensure that all training is consistent, no handler, trainer, or outside vendor is authorized to train to a standard that is not reviewed and approved by the canine supervisor.

Salt Lake City Police Department

SLCPD Policy Manual

SLCPD Policy Manual

Canines

309.13.2 FAILURE TO SUCCESSFULLY COMPLETE TRAINING

Any canine team failing to graduate or obtain certification shall not be deployed in the field for tasks the team is not certified to perform until graduation or certification is achieved. Pending successful certification, the canine handler shall be assigned to remedial canine handler training.

309.13.3 TRAINING RECORDS

All canine training records shall be maintained in the web-based canine training tracking system.

309.13.4 TRAINING AIDS AUTHORIZATION AND CONTROL

See the associated Canine Training Aids Authorization and Control Procedure.

309.14 RETIREMENT OF POLICE SERVICE CANINE

A police service canine will be retired at the decision of the canine supervisor based on: a recommendation of the veterinarian, due to the canine's age, for medical reasons, or unresolvable performance problems. When a police service canine reaches retirement, the accepting handler will purchase the dog for the sum of one dollar. At the discretion of the canine supervisor, the retired canine will be sold to the current handler or sold to the previous handler if the current handler is unable to accept the dog. The canine supervisor is authorized to find other suitable options for a retired police service canine that comport with Departmental and City Policies regarding the transfer of assets. A police service canine should only be euthanized as a last resort when no other suitable options are available. Once a police service canine has been retired and sold, Salt Lake City will no longer be responsible for care or liability.

309.15 REVISIONS

Enacted: March 5, 2018

Revised: May 21, 2018

Revised: April 4, 2023

Domestic Violence

310.1 PURPOSE AND SCOPE

The purpose of this policy is to provide the guidelines necessary to deter, prevent and reduce domestic violence through vigorous enforcement and to address domestic violence as a serious crime against society. The policy specifically addresses the commitment of this department to take enforcement action when appropriate, to provide assistance to victims and to guide department members in the investigation of domestic violence. This policy also addresses custodial interference investigations and complaints, as well as court orders often encountered in domestic violence-related investigations.

310.1.1 DEFINITIONS

Definitions related to this policy include:

Court order - All forms of orders related to domestic and dating violence, that have been issued by a court of this state or another, whether civil or criminal, regardless of whether service has been made.

Dating Partner - means the same as the term defined by [Utah Code 78B-7-102](#).

Dating Relationship - A dating relationship is defined by [Utah Code 78B-7-102](#).

Dating violence - Any criminal offense involving violence or physical harm, threat of violence or physical harm, or any attempt, conspiracy, or solicitation by a person to commit an offense involving violence or physical harm, when committed by a person against a dating partner of the person who is either 18 years of age or older or is emancipated.

Domestic violence - Domestic violence is defined in [Utah Code 77-36-1](#).

Intimate Partner - An intimate partner is defined by [Utah Code 77-36-2.1](#).

310.2 POLICY

The Salt Lake City Police Department's response to incidents of domestic violence and violations of related court orders shall stress enforcement of the law to protect the victim and shall communicate the philosophy that domestic violence is criminal behavior. It is also the policy of this department to facilitate victims' and offenders' access to appropriate civil remedies and community resources whenever feasible.

310.3 OFFICER SAFETY

The investigation of domestic violence cases often places department members in emotionally charged and sometimes highly dangerous environments. No provision of this policy is intended to supersede the responsibility of all department members to exercise due caution and reasonable care in providing for the safety of any department members and parties involved.

Salt Lake City Police Department

SLCPD Policy Manual

SLCPD Policy Manual

Domestic Violence

310.4 INITIAL INVESTIGATIONS

The following guidelines and attached flow chart ([See attachment: Domestic Violence Flow Chart.pdf](#)) should be followed by department members when investigating domestic violence or dating violence cases:

- (a) Calls of reported, threatened, imminent, or ongoing domestic violence or dating violence, and the violation of any court order is of extreme importance and should be considered among the highest response priorities. This includes incomplete 9-1-1 calls.
- (b) When practicable, department members should obtain and document statements from the victim, the suspect, and any witnesses, including children, in or around the household or location of occurrence.
- (c) Department members shall list the full name and date of birth of each child who was present in the household at the time of the offense.
- (d) All injuries should be photographed, regardless of severity, taking care to preserve the victim's personal privacy. Where practicable, photographs should be taken by a person of the same sex. Victims whose injuries are not visible at the time of the incident should be asked to contact the Department's non-emergency phone number in the event that the injuries later become visible.
- (e) Department members should request that the victim complete and sign an authorization for the release of medical records related to the incident when applicable. [See attachment: Health Records Authorization.pdf](#)
- (f) If the suspect is no longer at the scene, department members shall make reasonable efforts to locate the suspect to further the investigation, provide the suspect with an opportunity to make a statement and make an arrest if appropriate.
- (g) If a firearm or weapon was used in the alleged incident, the department member shall confiscate the weapon(s).
 - 1. This applies to both investigations involving domestic violence and dating violence ([Utah Code 77-36-2.1](#); [Utah Code 78B-7-408](#)).
- (h) When investigating domestic violence cases that involve strangulation, department members shall follow the domestic violence strangulation protocol ([Salt Lake City Police Department Procedure Manual: 321.2 PATROL RESPONSE TO DOMESTIC VIOLENCE STRANGULATION](#)).
- (i) When investigating domestic violence cases that involve intimate partners, department members shall complete a lethality assessment and refer to Procedure: 322 Domestic Violence Lethality Assessment.
- (j) When completing an incident or arrest report for violation of a domestic violence-related protective order, department members should include specific information that establishes that the offender has been served, including the date the offender was served, the name of the agency that served the order, and the provision of the order that the subject is alleged to have violated. When reasonably available, the arresting department members should attach a copy of the order to the incident or arrest report.

Salt Lake City Police Department

SLCPD Policy Manual

SLCPD Policy Manual

Domestic Violence

- (k) Department members shall make an arrest when there is probable cause to believe an offense outlined in [77-36-1\(4\)](#) UCA has occurred. Factors that should not be used as the sole justification for declining to take enforcement action include:
1. Marital status of suspect and victim.
 2. Whether the suspect lives on the premises with the victim.
 3. Claims by the suspect that the victim provoked or perpetuated the violence.
 4. The potential financial or child custody consequences of an arrest.
 5. The physical or emotional state of either party.
 6. Use of drugs or alcohol by either party.
 7. Denial that the abuse occurred where evidence indicates otherwise.
 8. A request by the victim not to arrest the suspect.
 9. Location of the incident (public/private).
 10. Speculation that the complainant may not follow through with the prosecution.
 11. The actual or perceived characteristics such as race, ethnicity, national origin, religion, sex, gender identity or expression, economic status, age, cultural group, social status, disability, professional position, or sexual orientation of the victim or suspect.

310.4.1 IF NO ARREST IS MADE

If no arrest is made, the department members should:

- (a) Advise the parties of any options, including but not limited to:
 1. Voluntary separation of the parties.
- (b) Document the resolution in a report.

310.5 DOMESTIC VIOLENCE INVESTIGATIONS INVOLVING OFFICERS AND/OR DEPARTMENT EMPLOYEES

310.5.1 DOMESTIC VIOLENCE INVOLVING SWORN POLICE OFFICERS AND OTHER EMPLOYEES OF THE SALT LAKE CITY POLICE DEPARTMENT OCCURRING WITHIN SALT LAKE CITY

When an officer or dispatcher receives notification of an alleged domestic violence incident involving a sworn officer or employee of the Salt Lake City Police Department, they will immediately notify the area Sergeant or the Watch Commander who will respond to the scene with the assigned units.

If the involved officer or employee is a supervisory level officer or employee, the Watch Commander shall be advised and respond.

Department members responding to complaints of domestic violence involving officers or employees of this department will respond to the scene and maintain the peace and integrity of

Salt Lake City Police Department

SLCPD Policy Manual

SLCPD Policy Manual

Domestic Violence

the scene. The Sergeant or Watch Commander shall request an outside agency to respond to handle the initial investigation.

If the on-scene investigation by the outside agency results in the arrest of the officer or employee, the following procedures will be followed:

- (a) Immediately following the arrest of the involved officer or employee, the on-scene supervisor will relieve them of duty with pay, pending further investigation. The supervisor will require the involved officer or employee to turn over all Department-owned badges, firearms, and assigned vehicles.
- (b) The on-scene supervisor or Watch Commander will notify the officer's or employee's respective Division Commander, who will in turn initiate an administrative investigation of the incident.
- (c) The Division Commander is responsible for notifying the Chief of Police or designee.

310.5.2 INCIDENTS OF DOMESTIC VIOLENCE INVOLVING OFFICERS OR EMPLOYEES OF THE DEPARTMENT OCCURRING OUTSIDE SALT LAKE CITY

Any officer or employee involved in a domestic violence situation will notify their Division Commander as soon as practicable.

A Division Commander, upon learning of an officer or employee under their command having been arrested, cited, or formally charged with a criminal offense resulting from an incident of domestic violence occurring outside the City, will immediately take the steps necessary to relieve the officer or employee from duty with pay, pending further administrative investigation. Further, the Division Commander will require the officer or employee to surrender all Department-owned badges, firearms, and assigned vehicle.

The Division Commander will initiate an administrative investigation of the incident and notify the Chief of Police or designee.

310.5.3 INCIDENTS OF DOMESTIC VIOLENCE INVOLVING PEACE OFFICERS OF OTHER JURISDICTIONS OCCURRING IN SALT LAKE CITY

When a department member or dispatcher receives notification of an alleged domestic violence incident involving a peace officer from any other agency, occurring within the City, they will immediately notify the area Sergeant or the Watch Commander who will respond to the scene with the assigned units.

The on-scene supervisor will closely scrutinize the investigation. If the investigation establishes probable cause to believe that an act of domestic violence has been committed and that the involved peace officer is the predominant aggressor, the investigating department member, with the concurrence of the on-scene supervisor, will arrest the involved party for the appropriate charge.

Following the arrest of a peace officer from an outside agency, the on-scene Sergeant will notify the Watch Commander.

Salt Lake City Police Department

SLCPD Policy Manual

SLCPD Policy Manual

Domestic Violence

Upon receiving notification of the arrest of an officer from an outside agency on charges incident to an act of domestic violence, it will be the responsibility of the Watch Commander to notify the arrested officer's agency, as well as this department's Investigations Division Commander or designee, as soon as practicable.

310.5.4 IDENTIFYING CLOTHING

In the event any peace officer or police employee is subject to arrest and will be placed in jail, the individual will be allowed to change out of his/her police-related clothing prior to arrival and booking at the jail facility if practicable.

310.6 VICTIM ASSISTANCE

Victims of domestic violence and dating violence may be traumatized or confused. Per [Utah Codes 77-36-2.1](#) and [78B-7-408](#) department members shall:

- (a) Seek medical assistance as soon as practicable for the victim if he/she has sustained an injury or complains of pain.
- (b) Recognize that a victim's behavior and actions may be affected.
- (c) Provide the victim with the department's blue victim information card, even if the incident may not rise to the level of a crime.
 - i. If the report is being taken telephonically, provide the victim with the information on the card and document the provision.
- (d) Stand by for a reasonable amount of time when an involved person requests law enforcement assistance while removing essential items of personal property.
- (e) Ask the victim whether he/she has a safe place to stay. Assist in arranging to transport the victim to an alternate shelter if the victim expresses a concern for his/her safety or if the department member determines that a need exists. Victim advocates may assist with this process (see the Victim and Witness Assistance Policy).
- (f) Make reasonable efforts to ensure that children or dependent adults who are under the supervision of the suspect or victim are being properly cared for.

310.7 LEGAL MANDATES AND RELEVANT LAWS

Utah law provides for the following:

310.7.1 STANDARDS FOR ARRESTS

- (a) Department members responding to a domestic violence call shall arrest or issue a citation to a domestic violence offender if there is probable cause to believe an offense has occurred. The offense need not occur in the department member's presence ([Utah Code 77-36-2.2](#)). Any citation issued shall note that the offense involved a domestic violence offense ([Utah Code 77-7-20](#)).
- (b) Department members who perform a lethality assessment on a domestic violence call that results in the victim being a "high risk" or if they believe that there is a risk of continued violence, then the department member shall transport and book into jail. In these scenarios, the issuance of a citation is not allowed per [Utah code 77-23-2.2](#).

Salt Lake City Police Department

SLCPD Policy Manual

SLCPD Policy Manual

Domestic Violence

- (c) Department members shall arrest a suspect whenever there is probable cause to believe that the suspect has violated any of the provisions of a court order or condition of release agreement and there is evidence the order has been served. The offense need not occur in the department member's presence ([Utah Code 77-36-2.4](#); [Utah Code 78B-7-119](#)).
- (d) If department members have probable cause to believe there will be continued violence against the victim or if there is evidence that the perpetrator has either recently caused serious bodily injury or used a dangerous weapon in the domestic violence offense, then the department members shall transport and book into jail. In these scenarios, the issuance of a citation is not allowed per [Utah Code 77-23-2.2](#). Factors that may support the likelihood of a continuing offense include:
 - 1. A prior history of arrests or citations involving domestic violence.
 - 2. The suspect is violating a court order.
 - 3. The suspect has a prior history of other assaultive behavior (e.g., arrests or convictions for assault and battery or aggravated assaults).
 - 4. Victim or witness statements that the suspect has a history of physical abuse toward the victim.
 - 5. Victim statements in which he/she expresses fear of retaliation or further violence should the suspect be released.
 - 6. Any other evidence that would indicate the victim may be subjected to continued violence or abuse.
- (e) In responding to domestic violence incidents, department members should generally be reluctant to make dual arrests. If department members receive complaints of domestic violence from two or more opposing persons, the department member shall evaluate each complaint separately to identify the predominant physical aggressor. If the department member determines that one person was the predominant physical aggressor, the department member need not arrest the other person alleged to have committed domestic violence.
- (f) Department members may not threaten, suggest, or otherwise indicate the possible arrest of all parties in order to discourage any party's request for intervention by law enforcement ([Utah Code 77-36-2.2\(4\)](#)).
- (g) Whenever a suspect is released by this department, the releasing department member shall then make a reasonable effort to notify the victim of that release and shall transmit that information to the statewide domestic violence network ([Utah Code 78B-7-802](#)).
- (h) Department members who do not make an arrest shall notify the victim of his/her right to initiate a criminal proceeding and of the importance of preserving evidence ([Utah Code 77-36-2.2](#)).
- (i) Whenever a complainant advises of the existence of a court order, the department member shall determine if a valid court order exists and use every reasonable means to enforce the order. The department member should determine whether the order is in the statewide domestic violence network ([Utah Code 78B-7-113](#)) and/or:

Salt Lake City Police Department

SLCPD Policy Manual

SLCPD Policy Manual

Domestic Violence

1. Whether a court order is on file with a law enforcement agency or whether the complainant has a copy of the court order in their possession.
 2. Whether proof of service or prior notice exists, whether the suspect was in court when the order was made, or whether it was provided by a court ex parte.
 3. The terms of the court order may be enforced against the suspect.
- (j) In the event, the suspect is no longer at the scene, department members shall document the incident for follow-up investigation.
- (k) If a custodial arrest is made or a citation is issued, the arresting department members shall provide both the arrestee and the victim a copy of the Salt Lake City Jail Release Agreement [Salt Lake City Police Department Policy Manual: 319.4.1 JAIL RELEASE AGREEMENTS](#). A copy of the Salt Lake City Jail Release Agreement will also be given to the jail staff as well as to the Salt Lake City Police Records Unit (see the Victim and Witness Assistance Policy for additional information on Jail Release Agreements). A copy of the Jail Release Agreement must be given to a member of the records unit as soon as reasonably possible. The Salt Lake City Jail Release Agreement shall contain the following information ([78B-7-802](#)):
1. The individual may not telephone, contact, or otherwise communicate directly or indirectly with the victim before being released.
 2. The individual may not be released except by court order or a written jail release agreement.
 3. Notification of the penalties for violation of the court order or any jail release agreement executed and that the individual must appear in court on the next business day after arrest.

310.7.2 DOMESTIC VIOLENCE ENHANCEMENTS

Per [Utah Code 77-36-1.1](#):

- (a) A Class C misdemeanor domestic violence charge can be enhanced to a Class B misdemeanor charge if the offender has been convicted of a qualifying domestic violence charge within the past 10 years or a criminal mischief offense within the past 5 years.
- (b) A Class B misdemeanor domestic violence charge can be enhanced to a Class A misdemeanor charge if the offender has been convicted of a qualifying domestic violence charge, excluding criminal mischief, within the past 10 years or a criminal mischief offense within the past 5 years.
- (c) A Class A misdemeanor domestic violence charge can be enhanced to a 3rd Degree felony if the offender has been convicted of a qualifying domestic violence charge, excluding criminal mischief offenses, within the past 10 years or a criminal mischief offense within the past 5 years.
- (d) An individual may be charged with a 3rd Degree felony if they have two or more convictions of qualifying domestic violence offenses, excluding criminal mischief,

Salt Lake City Police Department

SLCPD Policy Manual

SLCPD Policy Manual

Domestic Violence

within the past 10 years, or two or more convictions of qualifying domestic violence criminal mischief offenses within the past 5 years.

When making an arrest for a misdemeanor domestic violence offense, department members shall attempt to verify if the offender has any previous domestic violence convictions within the past 10 years. This may be accomplished by contacting records and requesting a criminal history check for any prior domestic violence convictions, or by checking the offender's criminal history through UCJIS or court exchange. If the offender has a qualifying domestic violence conviction within the past 10 years, they shall be booked into jail on the enhanced charge. The enhancement shall be noted in the probable cause statement.

Felony domestic violence charges cannot be enhanced for prior domestic violence convictions.

310.7.3 REPORTS AND RECORDS

- (a) Reports on all incidents of domestic violence shall include ([Utah Code 77-36-2.2](#)):
 1. The department members' disposition of the case.
 2. The appropriate crime classification for domestic violence.
 3. Marital status of each of the involved parties.
 4. The relationship of the suspect to the victim.
 5. Whether or not an arrest was made.
 6. If no arrest was made, the report shall detail the grounds for not arresting.
 7. If two parties are arrested, the report shall detail the grounds for arresting both parties.
- (b) The department members creating the report should provide the victim with the case number of the report. The case number may be placed in the appropriate space on the victim information handout provided to the victim. If the case number is not immediately available, the department members should explain to the victim how he/she can obtain the information at a later time.
- (c) The report, subject to redactions, shall be made available to the victim, upon request, at no cost ([Utah Code 77-36-2.2\(6\)\(d\)](#)).
- (d) The Records Unit shall forward a copy of the incident report to the appropriate prosecuting attorney within five days after the complaint of domestic violence occurred ([Utah Code 77-36-2.2\(6\)\(c\)](#)).
- (e) The department members completing a domestic violence report should include information regarding whether the victim would like the court to impose release restrictions upon the arrestee, including prohibiting the arrestee from having personal contact with the victim or from entering the victim's residence or other premises temporarily occupied by the victim ([Utah Code 78B-7-802](#)).
- (f) In cases where a lethality assessment was completed, department members shall include in any probable cause statement the results of the lethality assessment.

Salt Lake City Police Department

SLCPD Policy Manual

SLCPD Policy Manual

Domestic Violence

- (g) Department members shall not include in any probable cause statement or police report information regarding any details of the type of services offered or where a victim was referred for victim services. Instead, department members shall only document if services were offered.
- (h) The Records Unit shall update the statewide domestic violence network when a person is issued a citation for a domestic violence-related offense and a written jail release agreement is completed ([Utah Code 78B-7-802](#): [Utah Code 78B-7-113](#)).

310.7.4 LETHALITY ASSESSMENT SPECIFIC REPORTING REQUIREMENTS

Department members shall complete a general offense report for all cases where a lethality assessment was required. Department members shall include in their reports containing a lethality assessment along with the reporting requirements listed in the previous section:

- The intimate partner relationship between the involved parties that initiated the requirement of a lethality assessment.
- Whether or not a lethality assessment was completed and if not, why not.
- Whether or not the lethality assessment was reported to DPS and if not, why not.
- The results of the lethality assessment including:
 - If the victim was considered "HIGH RISK" or "NOT HIGH RISK."
 - If the victim was referred to services
- Department members will receive an e-mail from DPS containing the results of the lethality assessment, any analysis completed by DPS, and other related documents. Department members will convert that e-mail to a PDF and then add a supplemental report in Versadex where they will attach the PDF and any other documents they received to the case.

Department members shall include the results of a lethality assessment and any relevant analysis provided by DPS in any probable cause statement submitted at the jail while booking any arrest parties.

310.8 DOMESTIC VIOLENCE IN THE PRESENCE OF A CHILD

In any investigation of Domestic Violence, department members must pay special attention to and carefully document those instances in which a child is present.

A child is defined as any person less than 18 years of age.

In the presence of a child means:

- In the physical presence of a child; or
- Having knowledge that a child is present and may see or hear an act of domestic violence.

A charge of domestic violence in the presence of a child is separate and distinct from, and is in addition to, a charge of domestic violence where the victim is the cohabitant. Moreover, a person

Salt Lake City Police Department

SLCPD Policy Manual

SLCPD Policy Manual

Domestic Violence

who commits domestic violence in the presence of a child when more than one child is present is guilty of one offense for each child present when the violation occurred.

310.8.1 INVESTIGATIONS/REPORTS

In all cases of domestic violence in which a child is present, the department member shall include in their report:

- (a) The full name and date of birth of each child present.
- (b) The location of each child at the time of the incident and a description of the proximity of that child's location to the actual scene of the violence.
- (c) If the child is capable, a statement as received from the child of what each saw and/or heard.
- (d) A statement as to the apparent effect of the violence upon the child.

310.9 COURT ORDERS

Determining the validity of a court order, particularly an order from another jurisdiction can be challenging. Therefore, in determining whether there is probable cause to make an arrest for a violation of any court order, department members should carefully review the actual order when available, and, where appropriate and practicable:

- (a) Ask the subject of the order about his/her notice or receipt of the order, his/her knowledge of its terms, and efforts to respond to the order.
- (b) Check available records or databases that may show the status or conditions of the order.
- (c) Contact the issuing court to verify the validity of the order.
- (d) Contact a law enforcement official from the jurisdiction where the order was issued to verify the information.

Department members should document in an appropriate report their efforts to verify the validity of an order, regardless of whether an arrest is made. Department members should contact a supervisor for clarification when needed.

310.9.1 CRIMINAL PROTECTIVE ORDERS

These orders are issued by the Court directly to the defendant in a criminal case. They can be issued either at arraignment or at the time of adjudication. Such orders are served at the time they are issued and remain in force at the discretion of the court.

Criminal Protective Orders are not subject to revision or rescission by the victim in the case.

Criminal Protective Orders listed on the Statewide System may be recognized by the fact that the Plaintiff will be a governmental entity (i.e., Salt Lake City). The protected party will be identified on the statewide system as "other protected person."

Salt Lake City Police Department

SLCPD Policy Manual

SLCPD Policy Manual

Domestic Violence

310.9.2 CIVIL PROTECTIVE ORDERS

Civil Protective Orders are obtained from the Court by victims of domestic violence and/or dating violence. A department member shall, without a warrant, arrest an alleged perpetrator whenever there is probable cause to believe that the alleged perpetrator has violated any of the provisions of an ex parte protective order or protective order.

Civil Protective Orders are issued by the Court with various titles and are valid for varying periods of time. Some of these titles are:

- **Temporary Protective Order, Ex Parte Protective Order, or Ex Parte Protective Order on Behalf of Children** - This order is valid and enforceable only after it has been personally served on the Respondent by a peace officer. After service, this order is valid until the date of the court hearing stated in the order.
- **Amended Ex Parte Protective Order** - This order is issued as an order extending the hearing date for an Ex Parte Protective Order that has not been served. This order must be served personally by a peace officer before it is enforceable.
- **Order Extending Ex Parte Protective Order** - This order may be issued in either of two circumstances:
 - To extend the hearing date of an Ex Parte Protective Order not served. This order will not appear on the statewide system.
 - When a Protective Order has been issued but not served. This order will appear on the Statewide System as "Ex Parte Served/Protective Order Not Served." This order means that the Ex Parte Protective Order originally issued by the Court remains enforceable until the Protective Order is served.
- **Protective Order** - This order is issued following a court hearing in the matter. This order must be served by a peace officer before its provisions are enforceable. However, once a Protective Order is issued, the previously issued and served Ex Parte Protective Order remains in force until the Protective Order is served.
- **Mutual Protective Orders** - These orders are issued by the Court only after a hearing and a determination by the Court of the necessity to issue an order. This is the only order that is enforceable against both the Respondent and the Petitioner. This order is enforceable as any other Protective Order.

310.9.3 FOREIGN COURT ORDERS

Any foreign court order properly issued by a court of another state, Indian tribe, or territory shall be enforced by department members as if it were the order of a court in this state. An order should be considered properly issued when it reasonably appears that the issuing court has jurisdiction over the parties and reasonable notice and opportunity to respond was given to the party against whom the order was issued (18 USC § 2265). An otherwise valid out-of-state court order shall be enforced, regardless of whether the order has been properly registered with this state.

Foreign Protective Orders may or may not be listed on the Statewide System. The Petitioner should have a certified copy of the order. Examination of that copy should be the basis for the determination of validity.

Salt Lake City Police Department

SLCPD Policy Manual

SLCPD Policy Manual

Domestic Violence

Many foreign jurisdictions issue domestic violence Protective Orders under different titles (i.e., Restraining Orders). A department member may determine whether or not a foreign order is criminally enforceable in Utah by confirming it has within it two elements:

1. It was issued as a result of, or makes reference to, domestic violence; and
2. The order has criminal sanctions such as arrest or incarceration attached.

310.9.4 IMPORTANT POINTS ABOUT PROTECTIVE ORDERS

- (a) Except in the case of a Mutual Protective Order, the petitioner in a Civil Protective Order cannot criminally violate the order. Only the respondent can criminally violate the order.
- (b) A first offense violation of the criminal provisions of any domestic violence-related Protective Order is a class A misdemeanor. If a respondent has been previously convicted of a domestic violence offense within the previous five years, the violation may be enhanced to a third degree felony.
- (c) Violation of a dating violence Protective Order is a class B misdemeanor.
- (d) An arrest for a violation of any type of Protective Order requires a new case and case number.

310.9.5 SERVICE OF PROTECTIVE ORDERS

Typically, protective orders are served by the Civil Division of the Sheriff's Office. However, the Department will assist victims of domestic violence with service of orders of protection if:

- (a) The department has contact with the respondent and service is possible.
- (b) The department determines that under the circumstances, providing service of the order on the respondent is in the best interest of the petitioner.

When a department member serves an order of protection, the department member shall read all applicable sections of the order to the respondent. The department member will complete the return of service and immediately take it to the Records Unit. The respondent will be left with his/her copy of the order.

310.10 CUSTODIAL INTERFERENCE

Department members responding to and investigating reports of custodial interference will not enforce court orders of custody, as they are civil in nature. However, department members shall document any report of custodial interference for screening of criminal charges. When disagreement exists between the parents, the custodial status of the child will remain status quo.

310.10.1 WRITS OF ASSISTANCE

On occasion, department members may be presented with a Writ of Assistance, which is a court order from a judge directing peace officers to take action to return the custody of a child to a specific parent. In these cases, if there is a disagreement between the parents, department members shall contact a supervisor for consultation before taking action.

Salt Lake City Police Department

SLCPD Policy Manual

SLCPD Policy Manual

Domestic Violence

310.11 REVISIONS

Enacted: March 5, 2018

Revised: May 21, 2018

Revised: December 17, 2018

Revised: May 6, 2019

Revised: June 29, 2020

Revised: May 16, 2022

Revised: August 18, 2023

Search and Seizure

311.1 PURPOSE AND SCOPE

Both the federal and state Constitutions provide every individual with the right to be free from unreasonable searches and seizures. This policy provides general guidelines for Salt Lake City Police Department personnel to consider when dealing with search and seizure issues.

311.2 POLICY

It is the policy of the Salt Lake City Police Department to respect the fundamental privacy rights of individuals. Members of this department will conduct searches in strict observance of the constitutional rights of persons being searched. All seizures by this department will comply with relevant federal and state law governing the seizure of persons and property.

The Department will provide relevant and current training to officers as guidance for the application of current law, local community standards and prosecutorial considerations regarding specific search and seizure situations, as appropriate.

311.3 REASONABLENESS OF A SEARCH AND/OR SEIZURE

The U.S. Constitution affords protection for the individual against unreasonable search and seizure. To determine if any search is unreasonable, the courts balance the government's intrusion on the individual's Fourth Amendment protections and its promotion of legitimate governmental interests.

The reasonableness of a search is justified by the rationale leading to it, not the resulting seizure of incriminating property. With due consideration to the individual's rights, the courts cannot and will not allow a search based on a hunch or arbitrary judgment. Every step leading to a search and/or seizure must follow a logical progression, built upon a sound legal basis.

The Supreme Court has determined that the Fourth Amendment requires a warrant, or a judicially recognized exception to the warrant requirement, to search places where a person has a reasonable expectation of privacy. Examples of items or areas in which the courts have ruled that individuals do not have a reasonable expectation of privacy include:

- **Abandoned Property** - A person who abandons property has surrendered any privacy interest they may have had in the property.
- **Garbage** - When a person places garbage at the curb there is no longer any reasonable expectation of privacy in that garbage. Therefore, no Fourth Amendment protection is implicated by a search of that garbage.
- **Open Fields** - Defined by the United States Supreme Court as any unoccupied or undeveloped area outside the curtilage of a residence (*Oliver v United States*, 466 U.S. 170 (1984)).
- **Plain View** - There is no expectation of privacy in an object that is plain view to others from an area where the officer has a right to be. When a police officer sees an object in "plain view" and its value as contraband or evidence is readily apparent, the officer may seize it, as long as the officer can do so without moving or reaching into an area

Salt Lake City Police Department

SLCPD Policy Manual

SLCPD Policy Manual

Search and Seizure

in which the officer has no lawful right to be, and does not have to move or manipulate the item in order to ascertain its value as contraband or evidence.

- **Search by Non-Governmental Persons** - The Fourth Amendment does not provide protection against actions of private persons. Property seized by private persons, in a manner that would otherwise be illegal if seized by a government agent, does not violate the Constitution and may be provided to an officer for use in a criminal investigation. However, an officer may not use a private person as an "agent" to search if the officer would not otherwise be authorized to conduct the search.
- **Sniff- Dog or Human** - Generally, sniffing the air around a person or property that is in a public place or a place open to the public is not considered a search, as there is no reasonable expectation of privacy in the air.
- **Visual Aids or Heat Sensing Equipment** - The use of flashlights, photo surveillance, or heat sensing equipment to view or measure property that is otherwise open to public view is not considered a search, as it simply enhances the officer's senses. Some advanced technology has been held by the United States Supreme Court to require a warrant if it reveals the intimate details of persons within areas where they would hold a reasonable expectation of privacy (*Kyllo v. United States*, 533 U.S. 27 (2001)).

311.4 SEARCHES

The U.S. Constitution generally provides that a valid warrant is required in order for a search to be valid. There are, however, several exceptions that permit a warrantless search.

Examples of law enforcement activities that are exceptions to the general warrant requirement include, but are not limited to, searches pursuant to the following:

- Valid consent
 - The validity of the consent depends on the consent being given voluntarily. The courts determine the voluntariness of the consent based upon the totality of the circumstances. Some of the factors courts have considered in determining whether consent is voluntary include:
 - Knowledge of the right to refuse consent;
 - The consenting individual's experience with police procedures;
 - The number of police officers present;
 - Any threat of consequences if consent is not given;
 - Circumstances indicating use of force; and
 - The age, education, and intelligence of the individual.
 - Officers must also note that the extent of a consent search is limited by the consent given; the person can stop the search at any time, or restrict the breadth of the search at any time.
- Incident to lawful arrest
 - A search incident to lawful arrest is permissible in the following situations:
 - After a full custodial arrest and prior to transport, or

Salt Lake City Police Department

SLCPD Policy Manual

SLCPD Policy Manual

Search and Seizure

- After an arrest, even when a person is to be field released, if the officer has reason to believe there is a need to search for evidence related to the offense for which the person has been charged.
 - An officer has the authority to conduct a full search of the person of an arrestee following a full custodial arrest and prior to transport. The search incident to arrest of an arrestee who will be field released is limited to a search for evidence related to the offense with which the person is charged if the officer has reason to believe such evidence will be discovered. For example, a person arrested for shoplifting may be searched for additional stolen merchandise prior to being field released.
- Emergency Search of a Person
 - Various courts have allowed warrantless searches of persons when those searches are in response to emergency situations concerning an injured or unconscious person requiring aid, rather than a search for evidence to further a criminal investigation. The scope of an emergency search of a person is limited to the extent necessary to effectuate the purpose. Officers must be able to demonstrate that the emergency presented by the injured or unconscious person is readily apparent and there is a need to intrude upon the privacy interests of that person for one or more of the following reasons:
 - Identification of the person in order to contact relatives or friends;
 - Determination of the need for specific medication (e.g., medical bracelet, necklace, or card) or evidence of medication, etc.; and
 - Discovery of the nature of the injury or problem by examination.
- Exigent circumstances
 - Police may conduct an immediate, warrantless search or seizure under emergency conditions, if there is probable cause to believe that delay in getting a warrant would result in the loss of evidence, escape of the suspect, or harm to the police or public.
 - Officers are allowed to enter a home when a suspect retreats into the home or private area and there is reasonable fear of escape, destruction of evidence, or injury to the police or public.
 - When considering the matter of exigent circumstances, the courts examine criteria such as:
 - Was the offense serious or one of violence?
 - Was the suspect armed?
 - Was the probable cause strong enough to believe the suspect committed the crime?
 - Was there probable cause to believe the suspect was on the premises?
 - Did the police identify themselves and give the suspect a chance to surrender prior to entry?

Salt Lake City Police Department

SLCPD Policy Manual

SLCPD Policy Manual

Search and Seizure

- Was there an ongoing investigation or decision to arrest prior to the suspect fleeing into the premises?
- Exigent circumstances also exist if the police are responding to a domestic violence call. Entry may be made where a person's health, welfare, or safety is concerned.

Certain other activities are recognized by federal and state courts and by certain statutes as legitimate law enforcement activities that also do not require a warrant. Because case law regarding search and seizure is constantly changing and subject to interpretation by the courts, each member of this department is expected to act in each situation according to current training and their familiarity with clearly established rights as determined by case law.

Whenever practicable, officers are encouraged to contact a supervisor to resolve questions regarding search and seizure issues prior to electing a course of action.

311.4.1 SEARCHES OF CELL PHONES

With the exception of exigent circumstances, such as the safety of innocent persons (i.e., child abductions or bomb threats), or another judicially recognized exception to the warrant requirement, all searches of cell phones shall require a warrant. Searching a cell phone incident to arrest is not a judicially recognized exception to the warrant requirement and therefore shall not be done without a warrant (*Riley v. California*, 573 U.S. (2014)).

311.4.2 WARRANTLESS SEARCHES OF RESIDENCES

A search of a person's residence without a warrant is presumed to be unreasonable. Officers must be very careful about entering a home without a warrant and must be prepared to justify, in detail, any entrance to a residence based on an exception to the warrant requirement.

Abandoned Property

A person has no reasonable expectation of privacy in property that the person has intentionally or constructively abandoned. A police officer may enter such premises and this would not be a search under the Fourth Amendment.

The most likely application of this concept would be in an abandoned rental property. While the tenant who abandoned the property would no longer have a reasonable expectation of privacy, the landlord likely does. In such an instance, the officer must seek consent from the landlord or person with apparent authority over the premises to search the premises. Intent to abandon will not be presumed.

Whether abandonment has occurred will be determined by a review of all circumstances.

Open Field and Curtilage

Areas within the curtilage of a home are treated as a part of the residence and are highly protected by the Fourth Amendment. "Curtilage" is normally defined as the area around the home to which the activity of home life extends. To determine curtilage, the U.S. Supreme Court considers:

Salt Lake City Police Department

SLCPD Policy Manual

SLCPD Policy Manual

Search and Seizure

- (a) The proximity of the area to the home;
- (b) Whether the area is included within an enclosure surrounding the home;
- (c) The nature of the uses to which the area is put; and
- (d) The steps taken to protect the area from observation by people passing by.

The "open field" around a residence is defined as the unoccupied or undeveloped area outside of the curtilage. The Supreme Court has determined that there is no reasonable expectation of privacy in the open fields around a home and, therefore, a search of open fields does not raise a constitutional issue.

Consent Search of a Residence

The courts will look to the totality of the circumstances in determining whether or not the consent was voluntary.

The extent of the search is limited by the consent given. The subject can stop the search at any time, or restrict the breadth of the search at any time.

The extent of the search is limited to the area over which the consenting party has apparent authority.

If more than one person has apparent authority to consent and at least one declines consent, officers may not rely on consent of the other.

Whether or not a person has authority to consent to a search of particular property or a particular area depends on all of the facts known to the officers at the time. It is not necessary to prove that a person has actual authority; apparent authority is sufficient. The officer must be prepared to detail why the person giving consent was reasonably believed to have authority to do so. Officers may request consent to search from any person who has apparent authority over the immediate area to be searched or the object sought.

Joint occupants - spouses, partners, roommates - may consent to the search of shared areas, as well as areas under their own control. They may not consent to search of areas under the exclusive control of the other.

A parent may consent to the search of an area occupied by their child living at home. A child may not consent to the search of their parent's premises except those under the child's control. If the facts clearly show a non-familial relation between parent and child, (the parent is the child's landlord, an adult child shares rent with a parent, etc.), the rules of that relation prevail.

A host may consent to the search of premises occupied by a guest or visitor, but not to the search of a guest's personal property. A visitor or guest may not consent to the search of his/her host's premises. A long-term guest may acquire a tenant's right of privacy in some circumstances.

Mere permission to enter is not consent to search. It does establish lawful presence and therefore allows an officer to seize items immediately apparent as evidence or contraband in plain view. The consent to search one area does not allow search of other areas. The person may withdraw the

Salt Lake City Police Department

SLCPD Policy Manual

SLCPD Policy Manual

Search and Seizure

consent to search at any time. At such time the search must be stopped. Evidence or contraband found before then may be seized and the area secured.

Public Safety or Emergency Search of a Residence

This exception to the warrant requirement generally relates to situations in which it appears that a person may be hurt or in need of immediate medical assistance. Examples include welfare checks and domestic violence situations where the crime is ongoing.

This exception is based upon an immediate need to provide protection or aid, not on the need for investigation or the seriousness of an offense. Specifically, officers must have reasonable grounds to believe there is an immediate need to protect the life or safety of themselves or others to enter a property. Once on the property, the officer must limit the search to areas where it would be reasonable, in light of the nature of the emergency, to locate the person or thing and carry out the purpose of the entry (i.e., protecting the life or safety of themselves or another).

Officers should document the specific facts that gave rise to the belief that there was an immediate need to enter the property and the areas of the property searched in their report(s).

Protective Sweep/Exigency

Officers affecting an arrest inside a residence may, when they reasonably perceive an immediate danger to their safety, make a warrantless, protective sweep of a residence. Judicial decisions on protective sweeps have authorized them in two circumstances. They are:

1. When an officer is lawfully within a residence to affect an arrest and there are circumstances that give the officer a reasonable belief that there might be others within the residence that pose an immediate danger to the officer.
2. When officers arrest someone near the door, but outside a residence and there is reason to believe that a confederate might be within the residence that poses a danger to the officers. This exception will apply only when there is reason for either the officers to fear violence based on the nature of the crime or other information related to the arrestee or the arrestee's confederates.

The protective sweep exception to the warrant requirement does not authorize officers to search a residence simply because they are interviewing an occupant, either at the threshold or within the residence, when they are not making an arrest and there are not articulable reasons for believing someone might be within who poses a threat.

The search is limited to those areas in which the person may be found.

Hot Pursuit Search of a Residence

Pursuit must be "hot." Although an officer need not be in sight of the fleeing suspect, the officer must be in active pursuit of the fleeing suspect from the immediate commission of the crime if this exception is to be applied. Case law has determined that delay to wait for additional units and to plan an apprehension may remove the "hot pursuit" aspect and require a warrant.

The search is limited to those areas in which the person may be hiding.

Salt Lake City Police Department

SLCPD Policy Manual

SLCPD Policy Manual

Search and Seizure

Destruction of Evidence/Evanescent Evidence

Facts indicate the ongoing destruction, or the immediate danger of destruction, of contraband or crime-related evidence.

The search is limited to those actions necessary to preserve the evidence until a search warrant can be obtained.

Officers should note that the Utah Supreme Court has ruled that the smell of burning marijuana emanating from a home, by itself, does not create the exigent circumstances necessary to relieve the officer of the obligation to procure a warrant prior to entering and searching the home, in order to prevent the destruction of evidence (State v. Duran, 2007 UT 23).

It should also be noted that the United States Supreme Court has ruled that the natural metabolism of blood alcohol does not establish a per se exigency that would justify a blood draw without consent (Missouri v. McNeely, 569 U.S. 141 (2013)). Courts strongly disfavor and heavily scrutinize the practice of obtaining warrantless blood draws when an e-warrant can be obtained relatively quickly.

Search of a Residence Incident to Arrest

This warrant exception may apply if the officer is in the home lawfully and the arrest of the person is lawful.

The officer may search areas under the immediate control (or “wingspan”) of the arrestee if there is reason to believe there will be evidence of the crime of arrest or that a danger to the officer is present.

311.4.3 WARRANTLESS SEARCHES OF VEHICLES

Consent Searches

As in all consent searches, the issue of voluntariness must be addressed. The owner or a person with apparent authority over the vehicle (the driver) may consent to its search. A third party may give consent, if that person has joint access to or control over the vehicle, but officers must honor the ability of one with joint authority to decline consent.

The extent of the search is limited by the consent given. The subject can stop the search at any time, or restrict the breadth of the search at any time.

Search of Vehicles Incident to Arrest

Case law has determined that if an officer is making an arrest and the arrestee is handcuffed and secure, there is no basis for searching the arrestee's vehicle for officer safety purposes; the court has ruled that the arrestee no longer presents a danger by being able to grab a weapon. Attempts to leave an arrestee unsecured to justify a vehicle search could compromise an officer's safety and may be challenged as a ploy to circumvent the court's ruling.

Salt Lake City Police Department

SLCPD Policy Manual

SLCPD Policy Manual

Search and Seizure

Officers may still search the passenger compartment of a vehicle incident to arrest if it is reasonable to believe that the vehicle contains evidence of the offense of arrest (*Arizona v. Gant*, 556 U.S. 332 (2009)).

Probable Cause

An officer may search a vehicle if there is probable cause to believe there is contraband or evidence in the vehicle, and the vehicle is readily mobile. Some examples of evidence that may lead to probable cause include, but are not limited to:

- (a) A canine alerts on the vehicle;
- (b) An officer smells the odor of fresh or presently burning marijuana coming from the vehicle;
- (c) An officer sees contraband, narcotics, or paraphernalia in plain view in the vehicle; and
- (d) The arrestee makes statements about evidence or contraband in the vehicle.

The scope of a vehicle search is the same as would be authorized by a search warrant. The search shall be limited by the object of the search, and may include the passenger compartment, trunk, and all containers (locked or unlocked) belonging to the driver or passenger(s) within the vehicle.

Vehicle Frisk

For a vehicle to be frisked, the officer must have made a lawful investigatory stop based upon a traffic violation or reasonable suspicion of criminal activity, and the officer must have a reasonable suspicion that the persons in the vehicle are presently armed and dangerous.

The scope of a vehicle frisk is limited to those areas in the passenger compartment of the vehicle in which a weapon may be placed or hidden and readily accessible. For example, under the seat, in a door pocket, an unlocked center console, or an unlocked glove box.

Vehicle Inventory

The vehicle inventory is designed to protect the owner's property while it is in police custody, to protect Department members against claims of lost, damaged, or stolen property, and to protect members and the community from loss and potential danger. All vehicles meeting the criteria for inventory shall be inventoried. See the Vehicle Towing and Release Policy and associated Procedure for further detail.

Miscellaneous Vehicle Searches

If lawful authority for a search is present, officers will keep the following in mind:

- (a) Opening Locked Containers - When possible, officers shall open a locked container, trunk, or glove compartment with a key rather than by force.
- (b) Location of Search - Where the search of a vehicle is lawful and it is not feasible to conduct the search at the scene of the arrest, the vehicle shall be secured in police custody at all times until it is searched. The search shall be conducted as soon as practicable.

Salt Lake City Police Department

SLCPD Policy Manual

SLCPD Policy Manual

Search and Seizure

- (c) Search for Vehicle Identification Number (VIN) - An officer may remove items on the dashboard of a vehicle that are blocking the view of the public VIN from the outside of the vehicle if investigating an offense related to the ownership of the vehicle. This VIN is normally visible through the windshield. When checking the registration of a vehicle, the officer may compare the VIN on the registration with the VIN on the vehicle.
- (d) Motor Home/Mobile Home - A motor home or mobile home, if apparently mobile, is treated the same as a motor vehicle for the purposes of warrantless searches. Motor homes and mobile homes that are apparently affixed to a location (i.e., water hookups, skirts, lack of wheels) shall be treated as residences, not as vehicles.
- (e) Aircraft - Aircraft are subject to the same exceptions to the warrant requirement as are automobiles.
- (f) Abandoned Vehicle - If a vehicle is truly abandoned, there is no need for a search warrant or exception to the warrant requirement, as there would be no reasonable expectation of privacy in the vehicle. This does not include vehicles that are dismantled, or possibly junked on a person's private property. Any time a person would have a reasonable expectation of privacy in that vehicle, it is not abandoned.

311.4.4 CONSENT SEARCHES OF VEHICLES AND REAL PROPERTY

An officer may conduct a warrantless search of a vehicle or real property where consent is freely and voluntarily given by a person with actual or reasonably apparent authority to grant consent. Officers shall inform the person granting consent to search of their right to refuse consent prior to conducting a search. Officer should not request consent for a search if they already have probable cause to conduct a search.

The extent of the search is limited by the consent given. The consenting party can stop the search at any time, or restrict the breadth of the search at any time. A search based solely on consent may not exceed the scope or duration, so long as the consent remains the sole basis for the search. Officers should clearly define the area requested to be searched prior to beginning the search.

When an officer intends to search a vehicle or real property and consent is the sole basis for the search, the officer must obtain the signature of a person with actual or reasonably apparent authority to grant such consent on the SLCPD Consent to Search Form prior to conducting the search. In circumstances where consent to search is granted verbally but the consenting person refuses to sign the Consent to Search Form, officers will review all of the requirements of the consent search listed above with the person and document a renewal of consent on their body-worn camera prior to conducting the search. The refusal to sign the form will be noted on the Consent to Search Form along with a note of the date and time that renewed verbal consent was obtained.

When a request for a consent search request is refused, the refusal will be documented on the Consent to Search Form by the requesting officer. No search will be conducted after a refusal for consent is given.

All Consent to Search forms will be attached in the general offense report under the original case number for the incident.

Salt Lake City Police Department

SLCPD Policy Manual

SLCPD Policy Manual

Search and Seizure

[See attachment: SLCPD Consent to Search Form.pdf](#)

[See attachment: SLCPD Consent to Search Form - Fillable.pdf](#)

311.4.5 PAROLE SEARCHES

Absent a search warrant or other legal authority an officer may search the residence of a person on parole only after obtaining approval from a parole officer. In other circumstances where an officer stops a parolee and conducts a search of the parolee's person, personal effects or vehicle, the officer shall notify a parole officer as soon as reasonably practicable after conducting the search (Utah Code 77-23-301(3)(a) and (b)).

Officers shall not request or conduct a parole search for the purpose of harassment (Utah Code 77-23-301(4)).

311.4.6 IMAGING SURVEILLANCE DEVICE

An officer may not operate an imaging surveillance device to obtain information, not otherwise directly observable, about individuals, items, or activities within a closed structure unless (Utah Code 77-23d-103):

- (a) A warrant has been obtained.
- (b) Testing equipment or training is being performed.
 - 1. Training or testing may not be conducted as part of a criminal investigation or law enforcement activity.
 - 2. Testing or training requires the consent of the individuals imaged and the owners of the property to be imaged.
- (c) Exigent circumstances exist.
- (d) While in fresh pursuit of a person suspected committing a felony.

311.5 SEARCH PROTOCOL

Although conditions will vary and officer safety and other exigencies must be considered in every search situation, the following guidelines should be followed whenever circumstances permit:

- (a) Members of this department will strive to conduct searches with dignity and courtesy.
- (b) Officers should explain to the person being searched the reason for the search and how the search will be conducted.
- (c) Searches should be carried out with due regard and respect for private property interests and in a manner that minimizes damage. Property should be left in a condition as close as reasonably possible to its pre-search condition.
- (d) In order to minimize the need for forcible entry, an attempt should be made to obtain keys, combinations or access codes when a search of locked property is anticipated.
- (e) When the person to be searched is of the opposite sex as the searching officer, a reasonable effort should be made to summon an officer of the same sex as the subject to conduct the search. When it is not practicable to summon an officer of the same sex as the subject, the following guidelines should be followed:

Salt Lake City Police Department

SLCPD Policy Manual

SLCPD Policy Manual

Search and Seizure

1. Another officer or a supervisor should witness the search.
2. The officer should not search areas of the body covered by tight-fitting clothing, sheer clothing or clothing that could not reasonably conceal a weapon.

311.5.1 DUTY TO INTERCEDE

It is the expectation of this department that if officers observe a search or seizure being conducted by another officer without a warrant where it is clear, under the circumstances, that the search or seizure would not fit within an exception to the warrant requirement as outlined above; shall, if in a position to do so safely and without unreasonable risk to the safety of the officer or another individual, intervene to prevent the search or seizure from continuing to occur. Officers shall promptly report the situation to the supervisor of the observed officer (Utah Code 53-6-210.5).

311.6 SEIZURE OF PROPERTY

Property may be seized pursuant to a search warrant that particularly describes the item and provides authority for its seizure.

311.6.1 SEIZURE OF ITEMS IN PLAIN VIEW

An officer who is in a place that the officer has a lawful right to be may seize contraband or evidence of a crime, without a warrant, if the property is in plain view. This seizure is lawful, because a person has no expectation of privacy in an item that is in plain view.

It must be immediately apparent to the officer that the item is evidence or contraband simply by looking at the item. An officer may not manipulate the item or move it in any way. Doing so is a search and invokes the protections of the Fourth Amendment.

311.6.2 SEIZURE OF ITEMS UNDER PLAIN TOUCH

Contraband or evidence of a crime that is not visible to the human eye may be seized without a warrant under the plain touch doctrine if the officer is lawfully in the position to touch the item, such as during a lawful frisk, and the item's incriminating nature is immediately apparent to the touch. If further manipulation of the item is necessary to identify the item, the plain touch doctrine does not apply.

311.6.3 SEIZURE OF ITEMS UNDER PLAIN SMELL

Contraband or evidence of a crime may be seized without a warrant under the plain smell doctrine if the officer is lawfully present and lawfully able to access or seize the item that the officer smells without violating the Fourth Amendment, and the incriminating nature of the contraband or evidence is immediately apparent based on the smell.

Under the plain smell doctrine, the odor of contraband or evidence of a crime, such as burning marijuana, provides an officer with probable cause to search a vehicle without a warrant during a lawful traffic stop under the vehicle exception to the Fourth Amendment.

The Utah Supreme Court has ruled that although the plain smell doctrine provides officers probable cause to believe contraband or evidence of a crime may be found, it does not

Salt Lake City Police Department

SLCPD Policy Manual

SLCPD Policy Manual

Search and Seizure

automatically provide officers with exigent circumstances justifying a warrantless search of a private residence. The smell of burning marijuana emanating from a home, for example, by itself does not create the exigent circumstances necessary to relieve the officer of the obligation to procure a warrant prior to entering and searching the home.

311.7 DOCUMENTATION

Officers are responsible to document any search or seizure and to ensure that reports are sufficient including, at minimum, documentation of the following:

- Reason for the search
- Any efforts used to minimize the intrusiveness of any search (e.g., asking for consent or keys)
- What force, if any, was used to execute the search
- Whether an announcement was made prior to or after entry into the premises
- What, if any, injuries or damage occurred
- All steps taken to secure property
- The results of the search, including a description of any property or contraband seized
- If the person searched is the opposite sex, any efforts to summon an officer of the same sex as the person being searched and the identification of any witness officer

Supervisors shall review reports to ensure the reports are accurate, that actions are properly documented and that current legal requirements and department policy have been met.

311.7.1 ELECTRONIC INFORMATION AND DATA

Officers shall follow warrant and notification requirements when seeking electronic data or information transmitted to a provider of a remote computing service or through a provider of an electronic communication service (Utah Code 77-23c-102; Utah Code 77-23c-103; Utah Code 77-23c-104).

311.8 EMERGENCY CELL PHONE PINGS

311.8.1 DEFINITIONS

Ping - The act of determining the estimated current location of a cell phone. This may be accomplished via GPS data, or by using cell tower triangulation.

Exigent Circumstance Request - A demand made to cell phone companies to provide location information for a specific cell phone within a short period of time.

311.8.2 REQUIREMENTS FOR AN EMERGENCY PING

Pinging a cell phone is a search and seizure of the cell phone subscriber's location records. As such, pinging a cell phone is subject to established search and seizure laws. This includes the exigent circumstance exception. When an officer determines that the location of a cell phone is needed due to exigent circumstances, the officer should utilize an exigent circumstance request.

Salt Lake City Police Department

SLCPD Policy Manual

SLCPD Policy Manual

Search and Seizure

The requesting officer must be able to articulate exigent circumstances to include the immediate danger of death or serious bodily injury to any person. The officer must also be able to articulate the positive identity of the phone number, either from immediate family, long-term friends, or databases, which provide reasonable surety that the target phone number belongs to the subject in question.

311.8.3 EMERGENCY PING PROCEDURES

When conducting an emergency cell phone ping, officers shall follow proper procedure. [Salt Lake City Police Department Procedure Manual: 302.2 EMERGENCY PING PROCEDURE](#)

On occasion, members from outside entities (such as mental health workers) contact the Department through Dispatch requesting an emergency cell phone ping. If this occurs, proper procedures shall be followed. [Salt Lake City Police Department Procedure Manual: 302.3 PING REQUESTS FROM OUTSIDE ENTITIES](#)

311.8.4 REQUIRED DOCUMENTATION FOR EMERGENCY CELL PHONE PINGS

Whenever an emergency cell phone ping is conducted, members shall follow proper documentation procedures. [Salt Lake City Police Department Procedure Manual: 302.4 REQUIRED DOCUMENTATION FOR EMERGENCY PINGS](#)

311.9 REVISIONS

Enacted: March 5, 2018

Revised: October 5, 2020

Temporary Custody of Juveniles and Juvenile Operations

312.1 PURPOSE AND SCOPE

This policy provides guidelines consistent with the Juvenile Justice and Delinquency Prevention Act for juveniles taken into temporary custody by members of the Salt Lake City Police Department (34 USC § 11133). It also outlines the Department's commitment to preventing juvenile delinquency.

312.1.1 DEFINITIONS

Definitions related to this policy include:

Juvenile non-offender - An abused, neglected, dependent or alien juvenile who may be legally held for his/her own safety or welfare. This also includes any juvenile who may have initially been contacted for an offense that would not subject an adult to arrest (e.g., fine-only offense) but was taken into custody for his/her protection or for purposes of reuniting the juvenile with a parent, guardian, or another responsible person.

Juvenile offender - A juvenile under 18 who is alleged to have committed an offense that would subject an adult to arrest (a non-status offense). It also includes possession of a handgun by a person under 18 years of age in violation of Utah Code 76-10-509.4.

Non-secure custody - When a juvenile is held in the presence of a department member or another custody employee at all times and is not placed in a locked room, cell, or behind any locked doors (this does not include inside vehicles for transportation purposes). Juveniles in non-secure custody may be handcuffed but not to a stationary or secure object. Personal supervision, through direct visual monitoring and audio two-way communication, is maintained. Monitoring through electronic devices, such as video, does not replace direct visual observation.

Secure custody - When a juvenile offender is held in a locked room, a set of rooms, or a cell. Secure custody also includes being physically secured to a stationary object.

Sight and sound separation - Located or arranged to prevent physical, visual, or auditory contact.

Status offender - A juvenile suspected of committing a criminal violation of the law that would not be a criminal violation but for the age of the offender. Examples may include underage possession of tobacco, curfew violation, or truancy. A juvenile in custody on a court order or warrant based upon a status offense is also a status offender.

312.2 POLICY

The Salt Lake City Police Department is committed to releasing juveniles from temporary custody as soon as reasonably practicable and keeping juveniles safe while they are in the temporary custody of the Salt Lake City Police Department. Juveniles should be held in temporary custody

Salt Lake City Police Department

SLCPD Policy Manual

SLCPD Policy Manual

Temporary Custody of Juveniles and Juvenile Operations

only for as long as reasonably necessary for investigative purposes, processing, transfer, or release.

312.3 JUVENILES WHO SHOULD NOT BE HELD

Juveniles who exhibit any of the following conditions should not be held at the Salt Lake City Police Department:

- (a) Unconscious
- (b) Seriously injured
- (c) A known suicide risk or obviously severely emotionally disturbed
- (d) Significantly intoxicated
- (e) Extremely violent or continuously violent

Department members taking custody of a juvenile who exhibits any of the above conditions should take reasonable steps to provide medical attention or mental health assistance and notify a supervisor of the situation.

These juveniles should not be held at the Salt Lake City Police Department unless they have been evaluated by a qualified medical and/or mental health professional.

If a department member taking custody of a juvenile believes the juvenile may be a suicide risk, the juvenile shall be under continuous direct supervision until evaluation, release, or a transfer is completed.

312.4 CUSTODY OF JUVENILES

Department members have a wide range of alternatives they may employ when dealing with juvenile offenders, including:

- (a) Warnings;
- (b) Release to a parent, guardian, or another custodian;
- (c) Referral to diversion programs (see the Diversion Programs Policy);
- (d) Citations;
- (e) Screening of charges;
- (f) Placement in the Juvenile Receiving Center; and/or
- (g) Placement in the Detention Center.

Department members will use the least coercive alternative, consistent with preserving public safety and the safety of the juvenile when deciding what action to take with juvenile offenders.

Department members should take custody of a juvenile and temporarily hold the juvenile when there is no other lawful and practicable alternative to temporary custody. Refer to the Child Abuse Policy for additional information regarding detaining a juvenile that is suspected of being a victim. Juveniles may be taken into temporary custody without a court order if the department member has probable cause to believe that:

Salt Lake City Police Department

SLCPD Policy Manual

SLCPD Policy Manual

Temporary Custody of Juveniles and Juvenile Operations

- (a) The juvenile has committed an offense under municipal, state, or federal law;
- (b) The juvenile seriously endangers the juvenile's own welfare or the welfare of others, and taking the juvenile into temporary custody appears to be necessary for the protection of the juvenile or others;
- (c) The juvenile has run away or escaped from the juvenile's parents, guardian, or custodian; or
- (d) The juvenile is subject to the state's compulsory education law and is absent from school without a legitimate or valid excuse [Utah Code 53G-6-208](#).

No juvenile should be held in temporary custody at the Salt Lake City Police Department without notification to the arresting department member's supervisor or the Watch Commander.

Any juvenile taken into custody shall be released to the care of the juvenile's parent, guardian, or custodian or transferred to a juvenile custody facility or to another authority as soon as practicable, and in no event shall a juvenile be held in custody beyond six hours from the time of entry into the Salt Lake City Police Department (34 USC § 11133; Utah Code 80-6-203; Utah Code 80-6-204).

312.4.1 CUSTODY OF JUVENILE NON-OFFENDERS

Non-offenders taken into protective custody in compliance with the Child Abuse Policy should generally not be held at the Salt Lake City Police Department. Custodial arrangements should be made for non-offenders as soon as reasonably possible. Juvenile non-offenders may not be held in secure custody (34 USC § 11133;).

312.4.2 CUSTODY OF JUVENILE STATUS OFFENDERS

Status offenders should generally be released by citation or with a warning rather than taken into temporary custody. However, department members may take custody of a status offender in order to facilitate reunification (e.g., transported home or to the station to await a parent, transported to the juvenile's school, transported to the Juvenile Receiving Center, etc.). Juvenile-status offenders may not be held in secure custody (34 USC § 11133;).

If a juvenile citation is issued, or a juvenile is transported to the Juvenile Receiving Center, proper procedures will be followed.

[Salt Lake City Police Department Procedure Manual: 303.2 JUVENILE COURT MISDEMEANOR CITATIONS](#)

[Salt Lake City Police Department Procedure Manual: 303.3 JUVENILE RECEIVING CENTER](#)

312.4.3 CUSTODY OF JUVENILE OFFENDERS

Juvenile offenders should be held in non-secure custody unless another form of custody is authorized by this policy or is necessary due to exigent circumstances.

A juvenile offender may be taken into custody without an order of the court if:

Salt Lake City Police Department

SLCPD Policy Manual

SLCPD Policy Manual

Temporary Custody of Juveniles and Juvenile Operations

- (a) In the presence of the department member, the juvenile has violated state law, federal law, local law, or municipal ordinance.
- (b) There are reasonable grounds to believe the juvenile has committed an act which, if committed by an adult, would be a felony.

Department members who take a juvenile offender into temporary custody shall, without unnecessary delay, notify the parents, guardian, or custodian (Utah Code 80-6-203; Utah Code 76-10-1315).

A juvenile offender may not be held in temporary custody any longer than four hours for interrogation or to obtain the juvenile's name, age, residence, and other necessary information, and to contact the juvenile's parents, guardian, or custodian (Utah Code 80-6-204).

The juvenile offender shall be released to the care of a parent, guardian, or custodian unless the department member reasonably believes the juvenile's immediate welfare or the protection of the community requires the juvenile's detention (Utah Code 80-6-201).

If the juvenile offender is not released, the juvenile shall be taken to a place of detention or shelter without unnecessary delay (Utah Code 80-6-204). Before taking a juvenile to Detention, a department member shall confirm that the offense they are in custody for is one which permits their admittance to a secure detention facility (UAC R547-13-4; UAC R547-13-5; UAC R547-13-6; UAC R547-13-7; UAC R547-13-8; UAC R547-13-9; UAC R547-13-10; UAC R547-13-11; UAC R547-13-12; UAC R547-13-13; UAC R547-13-14; UAC R547-13-15), and shall follow proper procedure. [Salt Lake City Police Department Procedure Manual: 303.4 JUVENILE DETENTION FACILITY](#)

If the juvenile offender is placed in the Juvenile Receiving Center, proper procedures shall be followed. [Salt Lake City Police Department Procedure Manual: 303.3 JUVENILE RECEIVING CENTER](#)

If a juvenile is taken into custody for an offense for which charges need to be screened (typically a class A misdemeanor offense that does not qualify for booking into Detention or the issuance of a misdemeanor citation), proper screening procedures will be followed. [Salt Lake City Police Department Procedure Manual: 303.5 SCREENING CHARGES AGAINST JUVENILE OFFENDERS](#)

The department member who takes a juvenile offender to a detention or shelter facility shall promptly file with the detention or shelter facility a written report on a form provided by the Division of Juvenile Justice Services. This should include the details of the presently alleged offense, the facts which bring the juvenile within the jurisdiction of the juvenile court, and the reason the juvenile was not released by the Department (Utah Code 80-6-203).

312.4.4 UNGOVERNABLE JUVENILES

The Police Department will not respond to most calls of ungovernable juveniles. If a call for assistance involves an ungovernable juvenile, and there are aggravating circumstances (violence or other emergency situations), department members may be dispatched to respond.

Salt Lake City Police Department

SLCPD Policy Manual

SLCPD Policy Manual

Temporary Custody of Juveniles and Juvenile Operations

If a juvenile commits a crime, the appropriate arrest action shall be taken, regardless of whether the juvenile is ungovernable or not.

312.4.5 TRUANCY

Department members may take a juvenile believed to be truant into temporary custody for the purposes of transportation to an alternative intervention including a receiving center, a truancy center, back to school, or to their parents/guardians.

312.5 PARENTAL NOTIFICATION IN NON-ARREST SITUATIONS

If a department member has contact with a juvenile in which force is used, the juvenile is placed in handcuffs, or the department member draws and points his/her weapon at the juvenile, and the juvenile is subsequently released without arrest, the department member will make reasonable attempts to notify the juvenile's parent, guardian, or custodian to explain the circumstances of the contact. Proper procedures shall be followed by the department member to ensure that this notification occurs and is documented. [Salt Lake City Police Department Procedure Manual: 303.6 PARENTAL NOTIFICATION IN NON-ARREST SITUATIONS](#)

312.6 SPECIAL NOTIFICATIONS

If the juvenile is taken into custody for the offense of prostitution or sexual solicitation, the department member shall notify the Department of Child and Family Services (DCFS) Salt Lake City Police Department Procedure Manual: 303.8 JUVENILE PROSTITUTION NOTIFICATION TO DCFS, and the juvenile shall be taken to an authorized receiving center (Utah Code 76-10-1302). In these cases, the Organized Crime Unit will be contacted to determine proper placement.

312.7 NO-CONTACT REQUIREMENTS

Sight and sound separation shall be maintained between all juveniles and adults while in custody at the Salt Lake City Police Department (34 USC § 11133; Utah Code 80-6-203). There should also be sight and sound separation between non-offenders and juvenile and status offenders.

In situations where brief or accidental contact may occur, a member of the Salt Lake City Police Department shall maintain a constant, immediate presence with the juvenile or the adult to minimize any contact. If inadvertent or accidental contact does occur, reasonable efforts shall be taken to end the contact.

312.8 USE OF RESTRAINT DEVICES

Juvenile offenders may be handcuffed in accordance with the Handcuffing and Restraints Policy.

Other restraints should only be used after less restrictive measures have failed and with the approval of a supervisor. Restraints shall only be used so long as it reasonably appears necessary for the juvenile's protection or the protection of others.

Juveniles in restraints shall be kept away from other unrestrained juveniles or monitored in such a way as to protect the juvenile from abuse.

Salt Lake City Police Department

SLCPD Policy Manual

SLCPD Policy Manual

Temporary Custody of Juveniles and Juvenile Operations

312.9 PERSONAL PROPERTY

A department member taking custody of a juvenile offender or status offender at the Salt Lake City Police Department shall ensure a thorough search of the juvenile's property is made and all property is removed from the juvenile, especially those items that could compromise the safety, such as pens, pencils, and belts.

The personal property of a juvenile should be kept in a monitored or secure location until the juvenile is released from the custody of the Salt Lake City Police Department.

312.10 SECURE CUSTODY

Juveniles shall not be placed in secure custody for more than two hours (Utah Code 80-6-204). Supervisor approval is required before placing a juvenile offender in secure custody.

Secure custody should only be used for juvenile offenders when there is a reasonable belief that the juvenile is a serious risk of harm to him/herself or others.

Members of this department should not use secure custody for convenience when non-secure custody is or later becomes a reasonable option.

When practicable, handcuffing one hand of a juvenile offender to a fixed object while otherwise maintaining the juvenile in non-secure custody should be considered as the method of secure custody, rather than the use of a locked enclosure. An employee must be present at all times to ensure the juvenile's safety while secured to a stationary object.

Generally, juveniles should not be secured to a stationary object for more than 60 minutes. Supervisor approval is required to secure a juvenile to a stationary object for longer than 60 minutes and every 30 minutes thereafter. Supervisor approval should be documented.

312.10.1 LOCKED ENCLOSURES

Juvenile offenders shall not be placed in any locked enclosure unless the enclosure is certified by the Commission on Criminal and Juvenile Justice as an approved holding room, the facility meets the requirements of Utah Code 80-6-204, and there is no other alternative that will protect the juvenile and the community.

A thorough inspection of the area shall be conducted before placing a juvenile into the enclosure. A second inspection shall be conducted after removing the juvenile. Any damage noted to the room should be photographed and documented in the crime report.

The following requirements shall apply to a juvenile offender who is held inside a locked enclosure:

- (a) The juvenile shall constantly be monitored by an audio/video system during the entire time in custody.
- (b) Juveniles shall have constant auditory access to department members.
- (c) Initial placement into and removal from a locked enclosure shall be logged in a report.
- (d) Random personal visual checks of the juvenile by a staff member, no less than every 15 minutes, shall occur.

Salt Lake City Police Department

SLCPD Policy Manual

SLCPD Policy Manual

Temporary Custody of Juveniles and Juvenile Operations

1. All checks shall be logged in a report.
 2. The check should involve questioning the juvenile as to his/her well-being (sleeping juveniles or apparently sleeping juveniles should be awakened).
 3. Requests or concerns of the juvenile should be logged in a report.
- (e) Males and females shall not be placed in the same locked room.
- (f) Juvenile offenders should be separated according to the severity of the crime (e.g., felony or misdemeanor).
- (g) Restrained juveniles shall not be mixed in a cell or room with unrestrained juveniles.

312.11 INTERVIEW OR INTERROGATING OF JUVENILE SUSPECTS

Interviews or interrogations of juvenile suspects must follow the guidelines set in [Utah Code 80-6-206](#).

Refer to the Interrogation and Confessions Policy for further guidance on interviews, interrogations, and confessions.

312.12 FINGERPRINTS

Fingerprints of juveniles may be obtained without a court order or search warrant under the following circumstances:

- (a) The juvenile is 14 years of age or older and is being taken into custody for an offense that would be a felony if the juvenile were 18 years of age or older.
- (b) The juvenile is 14 years of age or older and consents to having their fingerprints taken.

If one of the above conditions is not met, a court order or search warrant is required to obtain fingerprints from a juvenile (Utah Code 80-6-608).

Photographs of all individuals (juveniles and adults) is governed under the Detentions and Photographing Detainees Policy.

312.13 RECORDS

Court decisions and legislation have combined to carefully specify situations in which information may be given out or exchanged when a case involves a minor. Juvenile record disclosures are governed by Utah Code 63G-2-302, 63G-2-305, and 53E-9-203.

Department members shall not divulge any information regarding juveniles in situations where they are uncertain of the legal authority to do so.

The Records Director should maintain a copy of any current policy of the juvenile court concerning the authorized release of information and appropriate acknowledgment forms.

Only information authorized by law will be released to other agencies.

312.14 JUVENILE OPERATIONS

The Salt Lake City Police Department recognizes the importance of preventing and combating juvenile delinquency. To meet its commitment to provide exceptional services to the community,

Salt Lake City Police Department

SLCPD Policy Manual

SLCPD Policy Manual

Temporary Custody of Juveniles and Juvenile Operations

the Department participates in preventive programs and actions coordinated by the Public Relations Unit designed to prevent young people from developing criminal tendencies.

The Salt Lake City Police Department recognizes the importance of having employees who are specially trained regarding the Juvenile Justice System. The School Resource Officers (SROs) serve as the Department's juvenile specialists and are assigned to the Investigations Division. The SROs assist in the development and implementation of delinquency prevention programs and act as a liaison between the Department, schools, and other components of the Juvenile Justice System.

312.14.1 ENCOUNTERS WITH STUDENTS ON SALT LAKE CITY SCHOOL DISTRICT PROPERTY OR AT SALT LAKE CITY SCHOOL DISTRICT EVENTS

There are additional contractual obligations of Salt Lake City Police Department department members when encountering students at Salt Lake City School District ("District") properties or events. These include:

- (a) If practicable, SLCPD department members should make contact with a school's assigned SRO or the SRO Sergeant before arriving at a school or school-sponsored event for law enforcement purposes.
- (b) SLCPD department members may arrest students on school property or at school-sponsored activities only when a department member has probable cause to believe that a student has been or is engaged in a crime that:
 1. Poses a real threat or immediate threat of injury to an individual or the public;
 2. Constitutes property damage;
 3. Involves possession or use of drugs, alcohol, or weapons; or
 4. When necessary to execute a warrant that cannot be effectively executed outside of school hours.
- (c) Incidents involving public order offenses including minor disorderly conduct, disturbance or disruption of schools or school activities, trespass, loitering, profanity, or fighting that does not involve physical injury or a weapon shall be considered administrative issues to be handled by school officials, rather than criminal law issues warranting formal law enforcement intervention.
- (d) SLCPD department members shall confer with school personnel to resolve issues related to offenses that are (1) a minor violation of the law and (2) status offenses.
- (e) SLCPD department members may conduct "Level Two" investigatory stops or detentions of students on school property or at school-sponsored events only when the department member has reasonable suspicion that the student has been, is, or is about to be engaged in the commission of a crime. This provision is not intended to prohibit casual communications or conversations intended to foster relationships between law enforcement and students that are not primarily intended for the purpose of investigating the criminal activity or identifying gang membership or association. This provision is also not intended to prohibit a student from voluntarily speaking to law enforcement. Except when an emergency or exigent circumstances exist, the SLCPD

Salt Lake City Police Department

SLCPD Policy Manual

SLCPD Policy Manual

Temporary Custody of Juveniles and Juvenile Operations

department member and school administrator should work together to determine when such questioning should take place in order to ensure the least amount of disruption to the student's learning and educational environment.

- (f) SLCPD department members will not photograph juveniles holding whiteboards identifying gang affiliation.
- (g) In any instance in which it becomes necessary for an SLCPD department member to detain, question, or search a minor student on school property or at a school-sponsored activity, the SLCPD department member will make reasonable efforts to ensure that an adult guardian or school administrator is present at all times, except in the case of exigent circumstances. All searches of students must be supported by probable cause to believe that the search will turn up evidence that the student has committed or is committing a criminal offense. An SLCPD department member shall not ask school administrators to conduct a search of a student's person, possessions, or locker in an effort to circumvent these protections. The reasonable efforts to contact an adult guardian or school administrator should be documented in a report or on a body camera.
- (h) SLCPD department members are prohibited from conducting strip searches of students for incidents occurring on School District property or at School District events.
- (i) The SLCPD shall make reasonable efforts to notify an adult guardian as soon as possible after a student is arrested on school property or at a school-sponsored event and in all cases within 24 hours. Those reasonable efforts should be documented in a report.

312.15 TRAINING

Department members should be trained and familiar with this policy and any supplemental procedures. This shall include training on how to properly use rooms designated for temporary custody of juveniles at least once every four years.

312.16 REVISIONS

Enacted: March 5, 2018

Revised: September 7, 2018

Revised: October 3, 2018

Revised: November 6, 2018

Revised: June 13, 2023

Adult Abuse

313.1 PURPOSE AND SCOPE

The purpose of this policy is to provide guidelines for the investigation and reporting of suspected abuse of certain adults who may be more vulnerable than others. This policy also addresses mandatory notification for Salt Lake City Police Department members as required by law.

313.1.1 DEFINITIONS

Definitions related to this policy include:

Adult abuse - Any offense or attempted offense involving violence or neglect of an adult victim when committed by a person responsible for the adult's care, or any other act that would mandate reporting or notification to a social service agency or law enforcement.

313.2 POLICY

The Salt Lake City Police Department will investigate all reported incidents of alleged adult abuse and ensure proper reporting and notification as required by law.

313.3 MANDATORY NOTIFICATION

Members of the Salt Lake City Police Department shall notify Adult Protective Services (APS) when the member has reason to believe that an elder or vulnerable adult has been abused. Members shall also notify APS when the member receives a report of adult abuse from a third party (Utah Code 62A-3-305).

For purposes of notification (Utah Code 62A-3-301):

- (a) Abuse includes, but is not limited to the intentional infliction of harm or emotional abuse, the exploitation or the neglect of an elder or vulnerable adult.
- (b) Elder adult means someone age 65 or older.
- (c) Vulnerable adult means a person age 18 or older who has a mental or physical impairment which substantially affects the person's ability to provide for themselves or their own personal protection.

313.3.1 NOTIFICATION PROCEDURE

The officer taking the initial report of adult abuse will make the required notification to APS. This notification can occur either by telephone or by utilizing the online reporting form provided by APS. Both options can be found at Adult Protective Services' website (<https://daas.utah.gov/adult-protective-services/>). The officer shall document the notification in their report. Detectives may make notification to APS by other means if other standard procedures are in place for a particular Unit, but the notification shall be documented.

313.4 INVESTIGATIONS AND REPORTING

All reported or suspected cases of adult abuse require investigation and a report, even if the allegations appear unfounded or unsubstantiated.

Salt Lake City Police Department

SLCPD Policy Manual

SLCPD Policy Manual

Adult Abuse

Investigations and reports related to suspected cases of adult abuse should address, as applicable:

- (a) The overall basis for the contact. This should be done by the investigating officer in all circumstances where a suspected adult abuse victim is contacted.
- (b) Any relevant statements the victim may have made and to whom he/she made the statements.
- (c) If a person is taken into protective custody, the reasons, the name and title of the person making the decision, and why other alternatives were not appropriate.
- (d) Documentation of any visible injuries or any injuries identified by the victim. This should include photographs of such injuries, if practicable.
- (e) Whether the victim was transported for medical treatment or a medical examination.
- (f) Whether the victim identified a household member as the alleged perpetrator, and a list of the names of any other potential victims or witnesses who may reside in the residence.
- (g) Identification of any prior related reports or allegations of abuse, including other jurisdictions, as reasonably known.
- (h) Previous addresses of the victim and suspect.
- (i) Other potential witnesses who have not yet been interviewed, such as relatives or others close to the victim's environment.
- (j) If any photographs or audio and/or video recordings of the victim were taken (Utah Code 62A-3-307).

Any unexplained death of an adult who was in the care of a guardian or caretaker should be considered as potential adult abuse and investigated similarly.

313.5 REMOVAL AND TRANSPORT OF ADULT ABUSE VICTIM

A peace officer may remove and transport, or cause to have transported, a vulnerable adult to an appropriate medical or shelter facility, if (62A-3-308):

- (a) The officer has probable cause to believe that:
 - i. By reason of abuse, neglect, or exploitation there exist exigent circumstances; and
 - ii. The adult abuse victim will suffer serious physical injury if not immediately removed and transported to a safe environment.
- (b) The adult abuse victim either refuses to consent or lacks capacity to consent to the removal and transport; and
- (c) There is not time to notify interested parties or to secure a warrant or other court order for the removal and transport.

The officer removing and transporting an adult abuse victim shall notify APS within four hours to request that an emergency protective order be obtained from the court (Utah Code 62A-3-308).

Salt Lake City Police Department

SLCPD Policy Manual

SLCPD Policy Manual

Adult Abuse

313.6 DETAINING VICTIMS FOR INTERVIEWS

An officer should not detain an adult involuntarily who is suspected of being a victim of abuse solely for the purpose of an interview or physical exam without his/her consent or the consent of a guardian unless one of the following applies:

- (a) Exigent circumstances exist, such as:
 - 1. A reasonable belief that medical issues of the adult need to be addressed immediately.
 - 2. A reasonable belief that the adult is or will be in danger of harm if the interview or physical exam is not immediately completed.
 - 3. The alleged offender is a family member or guardian and there is reason to believe the adult may be in continued danger.
- (b) A court order or warrant has been issued.

313.7 MEDICAL EXAMINATIONS

When an adult abuse investigation requires a medical examination, the investigating officer should obtain consent for such examination from the victim, guardian, agency or entity having legal custody of the adult. The officer should also arrange for the adult's transportation to the appropriate medical facility.

In cases where the alleged offender is a family member, guardian, agency or entity having legal custody and is refusing to give consent for the medical examination, officers should notify a supervisor before proceeding. If exigent circumstances do not exist or if state law does not provide for officers to take the adult for a medical examination, the supervisor should consider other government agencies or services that may obtain a court order for such an examination.

313.8 DRUG-ENDANGERED VICTIMS

A coordinated response by law enforcement and social services agencies is appropriate to meet the immediate and longer-term medical and safety needs of an adult abuse victim who has been exposed to the manufacturing, trafficking or use of narcotics.

313.8.1 OFFICER RESPONSIBILITIES

Officers responding to a narcotics crime scene where an adult abuse victim is present or where there is evidence that an adult abuse victim lives should:

- (a) Document the environmental, medical, social and other conditions of the adult, using photography as appropriate.
- (b) Notify the on-duty Sergeant and Watch Commander.

313.9 STATE MANDATES AND OTHER RELEVANT LAWS

Utah requires or permits the following:

313.9.1 RECORDS UNIT RESPONSIBILITIES

The Records Unit is responsible for:

Salt Lake City Police Department

SLCPD Policy Manual

SLCPD Policy Manual

Adult Abuse

- (a) Providing a copy of the adult abuse report to APS as required by law.
- (b) Retaining the original adult abuse report.

313.9.2 RELEASE OF REPORTS

Information related to incidents of adult abuse or suspected adult abuse shall be confidential and may only be disclosed pursuant to state law and the Records Maintenance and Release Policy (Utah Code 62A-3-312).

313.9.3 NOTIFICATION UPON ARREST

When an officer arrests a person 18 years of age or older for adult abuse, the officer shall provide the arrestee with the written notice required by Utah Code 77-20-3.5 [Salt Lake City Police Department Policy Manual: 319.4.1 JAIL RELEASE AGREEMENTS](#). Victims shall be provided notice in accordance with the Victim and Witness Assistance Policy.

313.10 REVISIONS

Enacted: March 5, 2018

Discriminatory Harassment

314.1 PURPOSE AND SCOPE

This policy is intended to prevent department members from being subjected to discrimination or sexual harassment.

314.2 POLICY

The Salt Lake City Police Department is an equal opportunity employer and is committed to creating and maintaining a work environment that is free of all forms of discriminatory harassment, including sexual harassment and retaliation. The Department will not tolerate discrimination against employees in hiring, promotion, discharge, compensation, fringe benefits and other privileges of employment. The Department will take preventive and corrective action to address any behavior that violates this policy or the rights it is designed to protect (Utah Antidiscrimination Act, Utah Code, Title 34A, Chapter 5).

The non-discrimination policies of the Department may be more comprehensive than state or federal law. Conduct that violates this policy may not violate state or federal law but still could subject an employee to discipline.

All employees shall be entitled to an equal opportunity to perform their required job duties, and each employee shall be dealt with on an individual basis in relation to the performance of those duties.

314.3 DEFINITIONS

314.3.1 DISCRIMINATION

The Department prohibits all forms of discrimination, including any employment-related action by a member that adversely affects an applicant or member and is based on race, color, religion, sex, age, national origin or ancestry, genetic information, disability, military service, sexual orientation and other classifications protected by law.

Discriminatory harassment, including sexual harassment, is verbal or physical conduct that demeans or shows hostility or aversion toward an individual based upon that individual's protected class. It has the effect of interfering with a member's work performance or creating a hostile or abusive work environment.

Conduct that may, under certain circumstances, constitute discriminatory harassment, can include making derogatory comments, crude and offensive statements or remarks, making slurs or off-color jokes, stereotyping, engaging in threatening acts, making indecent gestures, pictures, cartoons, posters or material, making inappropriate physical contact, or using written material or department equipment and/or systems to transmit or receive offensive material, statements or pictures. Such conduct is contrary to department policy and to the department's commitment to a discrimination free work environment.

Salt Lake City Police Department

SLCPD Policy Manual

SLCPD Policy Manual

Discriminatory Harassment

314.3.2 RETALIATION

Retaliation is treating a person differently or engaging in acts of reprisal or intimidation against the person because he/she has engaged in protected activity, filed a charge of discrimination, participated in an investigation or opposed a discriminatory practice. Retaliation will not be tolerated.

314.3.3 SEXUAL HARASSMENT

The Department prohibits all forms of discrimination and discriminatory harassment, including sexual harassment. It is unlawful to harass an applicant or a member because of that person's sex.

Sexual harassment includes, but is not limited to, unwelcome sexual advances, requests for sexual favors or other verbal, visual or physical conduct of a sexual nature when:

- (a) Submission to such conduct is made either explicitly or implicitly a term or condition of employment, position or compensation.
- (b) Submission to, or rejection of, such conduct is used as the basis for any employment decisions affecting the member.
- (c) Such conduct has the purpose or effect of substantially interfering with a member's work performance or creating an intimidating, hostile or offensive work environment.

314.3.4 ADDITIONAL CONSIDERATIONS

Discrimination and discriminatory harassment do not include actions that are in accordance with established rules, principles or standards, including:

- (a) Acts or omission of acts based solely upon bona fide occupational qualifications under the Equal Employment Opportunity Commission (EEOC) and the Utah Anti-Discrimination and Labor Division.
- (b) Bona fide requests or demands by a supervisor that a member improve his/her work quality or output, that the employee report to the job site on time, that the member comply with City or department rules or regulations, or any other appropriate work-related communication between supervisor and member.

314.4 RESPONSIBILITIES

This policy applies to all department personnel. All members shall follow the intent of these guidelines in a manner that reflects department policy, professional law enforcement standards and the best interest of the department and its mission.

Members who believe they are experiencing discrimination, harassment or retaliation are encouraged to inform the individual that his/her behavior is unwelcome, offensive, unprofessional or inappropriate.

Members are encouraged to promptly report any discriminatory, retaliatory or harassing conduct or known violations of this policy to a supervisor. Any member who is not comfortable with reporting violations of this policy to his/her immediate supervisor may bypass the chain of command and make the report to a higher ranking supervisor or manager. Complaints may also be filed with the

Salt Lake City Police Department

SLCPD Policy Manual

SLCPD Policy Manual

Discriminatory Harassment

Chief of Police, Director of Human Resources, the Mayor, the City's EEO program manager, the Department's Human Resource Consultant, or other City official.

Supervisors and managers receiving information regarding alleged violations of this policy shall proceed with resolution as stated below.

314.4.1 SUPERVISOR RESPONSIBILITY

Each supervisor and manager shall:

- (a) Continually monitor the work environment and strive to ensure that it is free from all types of unlawful discrimination, including sexual harassment or retaliation.
- (b) Ensure that members have open access to report harassing behaviors to their immediate supervisors, Human Resource Consultant, the City EEO Program Manager, or other City official.
- (c) Ensure that members who make complaints or who oppose any unlawful employment practices are protected from retaliation and that such matters are kept confidential to the extent possible.
- (d) Protect the rights of both complainants and alleged harassers.
- (e) If a member reports a violation of this policy to a supervisor, the supervisor shall, as soon as practicable, notify the city's EEO program manager as well as their Division Commander. The Division Commander will notify the appropriate Bureau Commander and Chief of Police.

314.5 INVESTIGATION OF COMPLAINTS

Complaints of conduct covered in this policy will be investigated in accordance with City policy and applicable Memorandums of Understanding.

314.6 NOTIFICATION OF DISPOSITION

Once the EEO Office has completed their investigation, they will provide the Chief of Police with their findings and recommendations. It is the responsibility of the Chief of Police to determine any disciplinary action to be taken, if necessary. The complainant and accused will be notified in writing of the disposition of the investigation and the action taken to remedy or address the circumstances giving rise to the complaint.

314.7 QUESTIONS OR CLARIFICATION

Members with questions regarding what constitutes discrimination, sexual harassment or retaliation are encouraged to contact a supervisor, manager, the Chief of Police, or the Director of Human Resources for further information, direction, or clarification.

314.8 REVISIONS

Enacted: March 5, 2018

Child Abuse

315.1 PURPOSE AND SCOPE

The purpose of this policy is to provide guidelines for the investigation of suspected child abuse. This policy also addresses when Salt Lake City Police Department members are required to notify the Division of Child and Family Services (DCFS) of suspected child abuse.

This policy does not address sexual abuse of children. Department members should refer to the Sexual Assault Investigations Policy for guidelines regarding the investigation of sexual maltreatment of children.

315.1.1 DEFINITIONS

Definitions related to this policy include:

Child - Unless otherwise specified by a cited statute, a child is any person under the age of 18 years.

Child Abuse - Child abuse means the same as the term "Abuse" as defined under [Utah Code 80-1-102](#).

Serious Physical Injury- Serious physical injury means the same as the term defined by [Utah Code 76-5-109](#).

Physical Injury - Physical injury means the same as the term defined by [Utah Code 76-5-109](#).

315.2 POLICY

The Salt Lake City Police Department will investigate all reported incidents of alleged criminal child abuse and ensure DCFS is notified as required by law.

315.3 MANDATORY NOTIFICATION

Department members of the Salt Lake City Police Department shall notify DCFS when there is reason to believe that a child has been subjected to child abuse, when they observe a child being subjected to conditions or circumstances that would reasonably result in child abuse, or when any person notifies the member of child abuse ([Utah Code 80-2-602](#)). Members shall also notify DCFS when there is reason to believe a juvenile is engaged in commercial sex or sexual solicitation ([Utah Code 76-10-1302](#)).

315.3.1 NOTIFICATION PROCEDURE

Notification should occur as follows ([Utah Code 80-2-602](#)):

- a. Notification shall be made immediately to the nearest DCFS office.
- b. The date and time of notification should be documented in the related report.

Juveniles engaged in commercial sex or sexual solicitation should be brought to a Utah Division of Juvenile Justice Services' receiving center, if available ([Utah Code 76-10-1315](#)). In instances

Salt Lake City Police Department

SLCPD Policy Manual

SLCPD Policy Manual

Child Abuse

where there is reason to believe that a child has died as a result of child abuse members shall notify the district attorney ([Utah Code 80-2-604](#)).

The proper procedure shall be followed for notifications to DCFS. [Salt Lake City Police Department Procedure Manual: 304.2 NOTIFICATION TO DCFS](#)

315.4 INVESTIGATIONS AND REPORTING

In all reported or suspected cases of child abuse, a report will be written. Department members shall write a report even if the allegations appear unfounded or unsubstantiated.

Investigations and reports related to suspected cases of child abuse should address, as applicable:

- (a) The overall basis for the contact. This should be done by the investigating department member in all circumstances where a suspected child abuse victim was contacted.
- (b) The exigent circumstances that existed if department members interviewed the child victim without the presence of a parent or guardian.
- (c) Any relevant statements the child may have made and to whom he/she made the statements.
- (d) If a child was taken into protective custody, the reasons, the name and title of the person making the decision, and why other alternatives were not appropriate.
- (e) Documentation of any visible injuries or any injuries identified by the child. This should include photographs of such injuries, if practicable.
- (f) Whether the child victim was transported for medical treatment or a medical examination.
- (g) Whether the victim identified a household member as the alleged perpetrator and a list of the names of any other children who may reside in the residence.
- (h) Identification of any prior related reports or allegations of child abuse, including other jurisdictions, as reasonably known.
- (i) Previous addresses of the victim and suspect.
- (j) Other potential witnesses who have not yet been interviewed, such as relatives or others close to the victim's environment.

All cases of the unexplained death of a child should be investigated as thoroughly as if it had been a case of suspected child abuse (e.g. a sudden or unexplained death of an infant).

When department members encounter a child engaged in commercial sex or sexual solicitation, department members should conduct an investigation into possible human trafficking of the child ([Utah Code 76-10-1302](#)).

315.4.1 INVESTIGATIONS INVOLVING SERIOUS PHYSICAL INJURY

Investigations involving serious physical injury shall be handled by Special Victims Unit personnel. If other department members (i.e., patrol officers) are first to respond to an incident that involves child abuse that includes serious physical injury, they should follow standard protocol for any

Salt Lake City Police Department

SLCPD Policy Manual

SLCPD Policy Manual

Child Abuse

serious criminal incident (see the Crime and Disaster Scene Integrity Policy). Call-out of Special Victims Unit personnel will go through the proper department chain-of-command.

315.4.2 INVESTIGATIONS INVOLVING PHYSICAL INJURY

Generally, investigations involving physical injury not amounting to serious physical injury will be handled by responding patrol department members. If circumstances lead a supervisor to believe an abuse investigation involving physical injury may need Special Victims Unit involvement, the Special Victims Unit Sergeant shall be contacted through the proper chain-of-command for consultation.

315.5 INTERVIEWS

315.5.1 CHILD INTERVIEWS

Absent extenuating circumstances or impracticality, department members should record interviews with suspected child abuse victims. Department members should avoid multiple interviews with a child victim and should use proper forensic interviewing techniques, which include but are not limited to:

- (a) Allow the child to explain what happened by responding to open-ended questions.
- (b) Avoid using an excessive amount of direct questions.
- (c) Avoid leading questions, when possible.
- (d) Avoid suggestive questions.
- (e) Limit interrupting the child's narrative.
- (f) Limit environmental distractions.

315.5.2 DETAINING SUSPECTED CHILD ABUSE VICTIMS FOR AN INTERVIEW

A department member should not detain a child involuntarily who is suspected of being a victim of child abuse solely for the purpose of an interview or physical exam without the consent of a parent or guardian unless one of the following applies:

- (a) Exigent circumstances exist, such as:
 - 1. A reasonable belief that the medical issues of the child need to be addressed immediately.
 - 2. A reasonable belief that the child is or will be in danger of harm if the interview or physical exam is not immediately completed.
 - 3. The alleged offender is the custodial parent or guardian and there is reason to believe the child may be in continued danger.
- (b) A court order or warrant has been issued.

Salt Lake City Police Department

SLCPD Policy Manual

SLCPD Policy Manual

Child Abuse

315.5.3 INTERVIEWS OF CHILDREN IN STATE CUSTODY

Department members should not interview a child who is in the custody of DCFS without the consent of the child's guardian ad litem. If a guardian ad litem has not been appointed, consent may be given by DCFS ([Utah Code 80-2-705](#)).

315.6 PROTECTIVE CUSTODY

Before taking any child into protective custody, the department member should make reasonable attempts to contact DCFS. Generally, the removal of a child from his/her family, guardian, or other responsible adult should be left to the child welfare authorities when they are present or have become involved in an investigation. If DCFS is not present or is in disagreement with department members, department members shall follow proper procedure. [Salt Lake City Police Department Procedure Manual: 304.3 DETERMINING A NON-DCFS REMOVAL](#)

Generally, members of this department should remove a child from his/her parent or guardian without a court order only when no other effective alternative is reasonably available and immediate action reasonably appears necessary to protect the child. Prior to taking a child into protective custody, the department member should take reasonable steps to deliver the child to another qualified parent or legal guardian, unless it reasonably appears that the release would endanger the child or result in abduction. If this is not a reasonable option, the department member shall ensure that the child is delivered to DCFS. This may be accomplished by DCFS responding to the scene, or by the department member transporting the child to the Christmas Box House. [Salt Lake City Police Department Procedure Manual: 304.4 TRANSPORTS TO CHRISTMAS BOX HOUSE](#)

Whenever practicable, the department member should inform a supervisor of the circumstances prior to taking a child into protective custody. If prior notification is not practicable, a department member should contact a supervisor promptly after taking a child into protective custody.

Children may only be removed from a parent or guardian in the following situations ([Utah Code 80-2a-202](#)):

- (a) When a court order or warrant has been issued authorizing the removal of the child.
- (b) When there exist exigent circumstances sufficient to relieve a department member of the requirement to obtain a warrant.
- (c) When a department member obtains the consent of the child's parent or guardian.

The above applies to removing a child from a home or school as well as from a parent or guardian.

315.6.1 SAFE HAVEN LAW

A birth parent or parent's designee may leave a newborn child, age 30 days or less at any Utah hospital that is open 24 hours. The hospital is responsible for contacting DCFS within 24 hours of receiving the infant and DCFS assumes legal custody of the infant ([Utah Code 80-4-501](#); [Utah Code 80-4-502](#)).

Salt Lake City Police Department

SLCPD Policy Manual

SLCPD Policy Manual

Child Abuse

315.7 MEDICAL EXAMINATIONS

If the child has been the victim of abuse that requires a medical examination, the investigating department member should obtain consent for such examination from the appropriate parent, guardian, or agency having legal custody of the child. The department member should also arrange for the child's transportation to the appropriate medical facility. For emergency or immediate care, medical personnel will make the determination of where the child will be transported. If emergency or immediate care is not needed, department members can refer the appropriate parent or guardian to The Center for Safe & Healthy Families. The Center for Safe & Healthy Families will coordinate with the parent/guardian for an appointment. [Salt Lake City Police Department Procedure Manual: 304.5 SAFE & HEALTHY FAMILIES REFERRAL](#)

In cases where the alleged offender is the custodial parent or guardian and is refusing consent for the medical examination, department members should notify a supervisor before proceeding. If exigent circumstances do not exist or if state law does not provide for a department member to take the child for a medical examination, the notified supervisor should consider obtaining a court order for such an examination.

315.8 DRUG-ENDANGERED CHILDREN

A coordinated response by law enforcement and social services agencies is appropriate to meet the immediate and longer-term medical and safety needs of children exposed to the manufacturing, trafficking or use of narcotics.

When investigating cases involving drug-endangered children, department members should:

- (a) Notify the on-duty Sergeant.
- (b) Document the environmental, medical, social and other conditions of the child, using photography as appropriate.
- (c) Document the child's accessibility to the endangering conditions including the mobility of the child.
 - i. Photographs showing measurements of a child's height and reach should be taken, as well corresponding measurements to the endangering conditions.
- (d) Document if the child received a medical assessment by emergency medical personnel and the patient disposition.
- (e) Contact DCFS.
- (f) Refer non-urgent medical assessments to the Center for Safe & Healthy Families.

315.9 STATE MANDATES AND OTHER RELEVANT LAWS

Utah requires or permits the following:

315.9.1 RELEASE OF REPORTS

Information related to incidents of child abuse or suspected child abuse shall be confidential and may only be disclosed pursuant to state law and the Records Maintenance and Release Policy ([Utah Code 77-37-4](#); [Utah Code 80-2-608](#)).

Salt Lake City Police Department

SLCPD Policy Manual

SLCPD Policy Manual

Child Abuse

315.9.2 RECORDED INTERVIEWS

A parent or guardian of a child victim may view a recorded interview of the child unless ([Utah Code 77-37-4](#)):

- (a) The suspect is also a parent or guardian of the child victim.
- (b) The suspect resides in the home with the child victim.
- (c) The investigator reasonably believes that allowing the parent or guardian to review the recording would compromise or impede the investigation.

The investigator should coordinate with the Children's Justice Center to ensure the permissible viewing takes place within two business days of the request.

315.9.3 NOTICE TO ARRESTEE

When a department member arrests a person 18 years of age or older for child abuse, the department member shall provide the arrestee with the written notice required by [Utah Code 78B-7-801](#) [Salt Lake City Police Department Policy Manual: 319.4.1 JAIL RELEASE AGREEMENTS](#). Victims shall be provided notice in accordance with the Victim and Witness Assistance Policy.

315.9.4 NOTICE TO THE DEPARTMENT OF CORRECTIONS

The Sex Offender/Child Abuse Offender Registry Detective shall ensure that the Department of Corrections is notified when a report is made of, or an arrest is made for, a violation of the Child Abuse Offender Registry law ([Utah Code 77-43-103](#)).

Department members writing reports involving violations of the Child Abuse Offender Registry will use the Sex Offender Registry violation NCIC codes to ensure proper routing to the Sex Offender/Child Abuse Offender Registry Detective.

315.10 REVISIONS

Enacted: March 5, 2018

Revised: July 26, 2019

Revised: October 2, 2023

Missing Adult Persons

316.1 PURPOSE AND SCOPE

This policy provides guidance for handling adult missing person investigations. Refer to the Missing Children and Runaways Policy for missing juveniles.

316.1.1 DEFINITIONS

Definitions related to this policy include:

Missing person - Any person who is 18 years of age or older and is reported missing to law enforcement when that person's location is unknown. This includes a person who is missing from his/her home environment and is physically or mentally disabled, missing under circumstances that indicate that the person is endangered, missing involuntarily or a victim of a catastrophe (Utah Code 26-2-27(1)(c)).

Missing person networks - Databases or computer networks that are available to law enforcement and are suitable for obtaining information related to missing person investigations. This includes the National Crime Information Center (NCIC), the Utah Bureau of Criminal Identification (BCI) Missing Persons Clearinghouse and the National Missing and Unidentified Persons System (NamUs).

316.2 POLICY

Members will initiate an investigation into all reports of missing persons, regardless of the length of time the person has been missing.

When a married person under the age of eighteen is reported missing by a spouse, the Homicide Squad shall handle the case as an adult missing person.

316.3 ACCEPTANCE OF REPORTS

Any member encountering a person who wishes to report a missing person shall render assistance. This can be accomplished by accepting the report via telephone or in-person and initiating the investigation. Those members who do not take such reports or who are unable to give immediate assistance shall promptly dispatch or alert a member who can take the report.

316.4 INITIAL INVESTIGATION

Officers or other members conducting the initial investigation of a missing person should take the following investigative actions, as applicable:

- (a) Respond to a dispatched call as soon as practicable.
- (b) Interview the reporting party and any witnesses to determine whether the person qualifies as a missing person and, if so, whether the person may be at risk, or qualifies for NCIC entry as a missing person.
- (c) Obtain an initial description (height, weight, hair and eye color, clothing last seen wearing, etc.).

Salt Lake City Police Department

SLCPD Policy Manual

SLCPD Policy Manual

Missing Adult Persons

- (d) Ensure that entries are made into NCIC when the missing person meets the NCIC qualifications.
- (e) Notify a supervisor immediately if there is evidence that a missing person is either at risk or may qualify for a public alert, or both (see the Public Alerts Policy and Procedure).
- (f) Complete the appropriate report forms accurately and completely and initiate a search as applicable under the facts.
- (g) Collect and/or review any evidence that may assist in the investigation, including personal electronic devices (e.g., cell phones, computers).
- (h) When circumstances permit and if appropriate, attempt to determine the missing person's location through his/her telecommunications carrier.
- (i) Contact the appropriate agency if the report relates to a missing person report previously made to another agency and that agency is actively investigating the report. When this is not practicable, the information should be documented in an appropriate report for transmission to the appropriate agency. If the information relates to an at-risk missing person, the member should notify a supervisor and proceed with reasonable steps to locate the missing person.

316.5 REPORT PROCEDURES AND ROUTING

Members should complete all missing person reports promptly and submit the report with the proper NCIC routing information. Generally, if the missing person resides outside of Salt Lake City, the person reporting the missing person should be referred to the agency in which the missing person resides. If the agency where the missing person resides declines to take the missing person report this agency will generate the missing person case.

Note there is no 24-hour time frame in which someone can be reported missing. A report can be made at any time.

316.5.1 NCIC ENTRY GUIDELINES

All persons under the age of 21 who are reported missing shall immediately be entered into NCIC as a missing person. Adults age 21 and older may be entered as a missing person using one of the following categories:

- **Disability:** Proven medical/mental disability or is senile, thereby subjecting them or others to personal and immediate danger.
 - This includes subjects who have walked away from nursing homes or medical facilities, are mentally/physically challenged, or those in need of medical assistance.
- **Endangered:** A person of any age who is missing under circumstances indicating that his/her physical safety may be in danger.
 - This includes suicidal subjects, or those believed to be the victim of a crime.
- **Involuntary:** A person of any age who is missing under circumstances indicating that the disappearance may not have been voluntary (i.e., abduction or kidnapping).

Salt Lake City Police Department

SLCPD Policy Manual

SLCPD Policy Manual

Missing Adult Persons

- **Juvenile** (see the Missing Children and Runaways Policy)
- **Catastrophe Victim:** A person of any age who is missing after a catastrophe.
- **Other:** A person not meeting the criteria for entry in any other category who is missing and
 - for whom there is reasonable concern for his/her safety; or
 - a person who is under age 21 and declared emancipated by the laws of his/her state of residence.

The age of the missing person and severe weather conditions should be considered. If the circumstances do not meet one of the above categories a report will still be generated using the proper NCIC code.

316.5.2 PATROL SUPERVISOR RESPONSIBILITIES

The responsibilities of the supervisor shall include, but are not limited to:

- (a) Reviewing and approving missing person reports upon receipt.
- (b) Ensuring resources are deployed as appropriate.
- (c) Initiating a command post as needed.
- (d) Ensuring applicable notifications and public alerts are made and documented (See the Public Alerts Policy and Procedure).
- (e) Ensuring that records have been entered into the appropriate missing person networks.
- (f) Taking reasonable steps to identify and address any jurisdictional issues to ensure cooperation among agencies.
 - i. If the case falls within the jurisdiction of another agency, the supervisor should facilitate the transfer of the case to the agency of jurisdiction.

316.5.3 RECORDS UNIT RESPONSIBILITIES

The responsibilities of the Records Unit receiving member shall be to coordinate with the NCIC Terminal Contractor for Utah, to have the missing person record in the NCIC computer networks updated with additional information obtained from missing person investigations (42 USC § 5780).

316.6 INVESTIGATIONS DIVISION FOLLOW-UP

Any case in which a missing person has been listed on NCIC as a missing person shall be assigned to a follow-up detective as an Open/Active case.

Non-NCIC missing person cases will generally be closed by follow-up personnel unless there are other circumstances that would require follow-up by a detective.

In addition to completing or continuing any actions listed above, the investigator assigned to a missing person investigation:

Salt Lake City Police Department

SLCPD Policy Manual

SLCPD Policy Manual

Missing Adult Persons

- (a) Should recontact the reporting person and/or other witnesses within 30 days of the initial report and within 30 days thereafter to determine if any additional information has become available.
- (b) Should conduct a follow-up search as applicable under the facts.
- (c) Should consider contacting other agencies involved in the case to determine if any additional information is available.
- (d) Shall verify and update the Missing Persons Clearinghouse, NCIC, and any other applicable missing person networks within 30 days of the original entry into the networks and every 30 days thereafter until the missing person is located (34 USC § 41308).
- (e) Should continue to make reasonable efforts to locate the missing person and document these efforts at least every 30 days.
- (f) Should make an appropriate inquiry with the Medical Examiner.
- (g) Should consider making appropriate entries and searches in the National Missing and Unidentified Persons System (NamUs).
- (h) When an adult has been missing for 90 days the missing person should be entered into NamUs. Exceptions to this should be cleared through the follow-up detective's supervisor. This does not preclude entry into NamUs prior to 90 days if the detective determines it necessary.
- (i) Should obtain and forward to the appropriate entities, medical and dental records, fingerprint card, photos, X-rays and biological samples, as applicable.
- (j) A voluntarily provided biological sample of the missing person, if available (e.g. toothbrush, hairbrush) for possible NamUs entry.
- (k) Any documents that may assist in the investigation, such as court orders regarding custody.
- (l) In the case of an at-risk missing person or a person who has been missing for an extended time, should consult with a supervisor regarding seeking federal assistance from the FBI and the U.S. Marshals Service (28 USC § 566).

316.7 WHEN A MISSING PERSON IS FOUND

When a missing adult is located that was listed on NCIC by this department, the assigned officer shall ensure the Records Unit sends an NCIC hit. The officer will then complete a supplemental report to the original Salt Lake City case number.

When a missing adult is located that was listed on NCIC by another jurisdiction, the assigned officer shall obtain an on-view case number and ensure the Records Unit sends an NCIC hit to the originating agency.

When any person reported missing is found, the finder shall document the location of the missing person in the appropriate report, notify the relatives and/or reporting party, as appropriate, and other involved agencies, and refer the case for additional investigation if it is warranted. When making notification, inform the complainant that the missing person has been located, do not give

Salt Lake City Police Department

SLCPD Policy Manual

SLCPD Policy Manual

Missing Adult Persons

any additional information as to the circumstances or location of the missing person without the permission of the missing person.

The Records Unit should ensure that, upon receipt of information that a missing person has been located, the following occurs:

- (a) Notification is made to the Utah BCI for removal from applicable criminal justice information systems.
- (b) Entries are made in the applicable missing person networks.
- (c) Notifications shall be made to any other law enforcement agency that took the initial report or participated in the investigation.

316.7.1 UNIDENTIFIED PERSONS

Department members investigating a case of an unidentified person who is deceased or a living person who cannot assist in identifying him/herself should:

- (a) Obtain a complete description of the person. If possible, this should include a DNA sample, dental information, and fingerprints.
- (b) Request BCI enter the unidentified person's description into the NCIC Unidentified Person File.
- (c) Use available resources, such as those related to missing persons, to identify the person.

316.8 REVISIONS

Enacted: March 5, 2018

Revised: May 21, 2018

Revised: November 6, 2018

Missing Children and Runaways

317.1 PURPOSE AND SCOPE

This policy provides guidance for handling missing children and runaway investigations. Refer to the Missing Persons Policy for missing adults.

317.1.1 DEFINITIONS

Definitions related to this policy include:

Missing child – A person who is younger than 18 years of age and whose whereabouts are unknown to his or her custodial parent, guardian, or responsible party.

Runaway - A child who leaves home without the intention of returning. The child may have left home alone or with another party who is not a parent or guardian. Children will not be assumed to be runaways due solely to their age; there must be other indication(s). Such indication(s) include, but are not limited to, a documented history of running away, statements from the child before leaving, statements from parents, statements from friends, and notes.

Risk factors - Risk factors refer to a missing child or runaway who is:

1. 12 years of age or younger; **or**
2. Believed or determined to be experiencing one or more of the circumstances below.
 - (a) Has mental or behavioral disabilities that place them in danger of exploitation or harm.
 - (b) Is dependent on medication, and the dependency is potentially life-threatening.
 - (c) Is in a life-threatening situation.
 - (d) Is in the company of others who would likely endanger his or her welfare.
 - (e) Is involved in a situation causing a reasonable person to conclude the child should be considered at risk.

317.2 POLICY

It shall be the policy of this department to investigate all reports of missing children and runaways.

Jurisdictional conflicts are to be avoided when a child is reported missing. If a missing child either resides in, or was last seen in this jurisdiction, this agency will initiate the required reporting process. If a child resides in this jurisdiction and was last seen in another jurisdiction, but the law enforcement agency covering that jurisdiction chooses not to make a missing child report, this agency will assume reporting and investigative responsibility.

Questions concerning parental custody occasionally arise in relation to missing child reports. It shall be the policy of this department to accept the report of a missing child even if custody has not been formally established. Reporting parties shall be encouraged to obtain legal custody as soon as possible; however, since the safety of the missing child(ren) is paramount, members of this agency will open a case when it can be shown the child has been removed, without explanation,

Salt Lake City Police Department

SLCPD Policy Manual

SLCPD Policy Manual

Missing Children and Runaways

from his or her usual place of residence. If custody has not been established by the Court, then the law enforcement responsibility is to ensure the child is safe only.

317.3 ENTERING JUVENILES ON NCIC

All juveniles reported missing (including runaways) shall be entered on NCIC in accordance with US Code Title 42 Chapter 72 Section 5779 (Suzanne's Law).

An official police report must be made based on a complaint by the parent, guardian, or responsible party, indicating the status of the juvenile as a runaway or missing child. The date of last contact must also be recorded. The Records Unit will list the runaway or missing child on NCIC immediately upon being contacted by the initial officer or dispatch of the missing child or runaway.

Juveniles entered on NCIC will remain so until an officer has the Records Unit remove them when located and the case is resolved.

Due to Suzanne's Law, if the juvenile reaches the age of 18 before being located, the Youth case will be reviewed and the juvenile will be modified on NCIC. The information will be passed on to the Homicide Squad. If circumstances require that the person must be removed from NCIC, the detective handling the adult missing person case will do so.

317.4 ACTIONS UPON DETERMINATION OF RISK FACTORS

If it is determined risk factors are involved in the report of a missing child or runaway, the child will be considered at risk. An expanded investigation, including the use of all appropriate resources, will immediately commence.

If appropriate, and if applicable criteria are met, existing interagency response protocols (including the AMBER Alert system, Endangered Missing Advisories, and A Child Is Missing (ACIM) Alert) should be considered (see the Public Alerts Policy and Procedure).

317.5 MISSING CHILD INVESTIGATIONS

317.5.1 DISPATCH RESPONSIBILITIES

Dispatch personnel receiving the report of a missing child shall:

- (a) Determine if circumstances of the report meet the definition of a missing child.
- (b) Transmit the appropriate radio alerts and other notifications.
- (c) Dispatch, in a prompt manner, 3 patrol officers to the scene of the report.
- (d) Notify the appropriate patrol Sergeant and Watch Commander.
- (e) If possible, search agency records for related information, specifically any records such as those pertaining to the family, the place where the child was last seen, and the child's residence.

317.5.2 INITIAL OFFICER RESPONSIBILITIES

The initial officer assigned to the report of a missing child shall:

- (a) Respond promptly to the scene of the report.

Salt Lake City Police Department

SLCPD Policy Manual

SLCPD Policy Manual

Missing Children and Runaways

- (b) Confirm the child is in fact missing.
- (c) Conduct an immediate and thorough search of the scene for the missing child.
- (d) Interview the parent(s) or person who made the initial report.
- (e) Obtain a detailed description of the missing child, including photographs.
- (f) Verify the child's custody status.
- (g) Identify the circumstances of the missing episode.
- (h) Determine when, where, and by whom the missing child was last seen.
- (i) Interview the individual(s) who last had contact with the missing child.
- (j) Make an initial assessment of the type of incident.
- (k) Obtain a description of the suspected abductor(s) and other pertinent information, if applicable.
- (l) Notify the Records Unit for NCIC entry.
- (m) Provide detailed descriptive information to Dispatch for broadcast updates.
- (n) If applicable, protect the scene, area of the child's home, and areas of interest as potential crime scenes.
- (o) Inquire if the child has access to the Internet, cell phone, and/or other communications device.
- (p) Prepare necessary reports and complete appropriate forms.
 - i. The initial officer shall write a report in all missing child cases, which shall include where and with whom the child(ren) is found with. This is vital for reference purposes in case the child is reported missing again.

317.5.3 ASSISTING OFFICER RESPONSIBILITIES

Assisting officers assigned to the report of a missing child shall:

- (a) Assist in an immediate and thorough search of the scene for the missing child.
- (b) Begin an area search for the missing child, concentrating on reported friends' houses, areas that would attract children such as parks and playgrounds, and hazards such as swimming pools.
- (c) Assist the initial officer as needed.

317.5.4 SUPERVISOR RESPONSIBILITIES

The supervisor assigned to the report of a missing child shall:

- (a) Obtain a briefing from the initial officer and other agency personnel at the scene.
- (b) Determine if additional personnel and resources are needed to assist in the investigation.
 - i. If it is determined that a detective response is necessary, the Watch Commander will notify the Investigations Division.

Salt Lake City Police Department

SLCPD Policy Manual

SLCPD Policy Manual

Missing Children and Runaways

- (c) Consult with the Watch Commander to determine if any public alert systems should be utilized (see the Public Alerts Policy and Procedure).
- (d) If the situation dictates, establish a command post.
- (e) Organize and coordinate search efforts.
- (f) Ensure all required notifications have been made.
- (g) Establish a liaison with the victim family.

Until transfer of command is formally made to an Investigations Division Commander or their designee, the Watch Commander will remain the Incident Commander for missing child(ren) investigations, and the handling Patrol Division will retain primary responsibility for the investigation.

317.5.5 INVESTIGATOR RESPONSIBILITIES

If detectives are called out, or otherwise assigned the case, the responsible investigator shall:

- (a) Obtain a briefing from agency personnel at the scene.
- (b) Verify the accuracy of all descriptive information.
- (c) Initiate a neighborhood investigation.
 - 1. A thorough canvass of the neighborhood should be conducted without delay. The objective is to identify and interview all people within the abduction zone who may be able to provide information related to the incident. A record of homes where contact was and was not made should be generated, along with any other conditions that may have future investigative value. Access should also be made to the Sex Offender Registry to determine if individuals designated as sex offenders reside, work, or are otherwise associated with the area.
- (d) Obtain a brief history of recent family dynamics.
- (e) Explore the basis for any conflicting information.
- (f) Complete all remaining key investigative and coordination steps.
- (g) Implement effective case management.
- (h) Evaluate the need for additional resources and specialized services.
- (i) Update descriptive information.
- (j) Monitor media relations.
- (k) Promptly notify the National Center for Missing and Exploited Children (NCMEC) when the child is missing from a foster care family or childcare institution (34 USC § 41308).
- (l) Attempt to obtain the most recent photograph if it has not been obtained previously and forward the photograph to the Utah BCI and enter the photograph into applicable missing person networks (34 USC § 41308).

317.5.6 RECOVERY OR RETURN OF A MISSING CHILD

An officer assigned to the recovery or return of a missing child shall:

Salt Lake City Police Department

SLCPD Policy Manual

SLCPD Policy Manual

Missing Children and Runaways

- (a) Verify the located child is, in fact, the reported missing child.
- (b) Secure intervention and/or medical services, if appropriate.
- (c) Arrange the return of the child to his or her legal guardian or an appropriate children's shelter.
- (d) Complete the appropriate supplemental report(s) and cancel all outstanding notifications, including the NCIC listing.

317.6 RUNAWAY INVESTIGATIONS

The report of a runaway must be made by the parent, guardian, or responsible party, indicating the status of the juvenile as a runaway. Generally, runaway reports should be handled by the agency who has jurisdiction over where the child resides.

Runaway investigations where the runaway is not considered at risk may be handled telephonically or in-person. If the runaway is determined to be at risk, the investigating officer shall respond in person and consult with their supervisor to determine which resources and processes outlined in the Missing Child Investigations section above are appropriate, based on present risk factors and circumstances of the case (i.e., how long the runaway has been missing, where the runaway was last seen, etc.).

In any case, the investigating officer shall:

- (a) Handle the call promptly.
- (b) Confirm the child is, in fact, a runaway and is or is not at risk.
- (c) Obtain a detailed description of the runaway, including photographs if possible.
- (d) Verify the child's custody status.
- (e) Determine when, where, and by whom the runaway was last seen.
- (f) Notify the Records Unit for NCIC entry.
- (g) Inquire if the runaway has access to the Internet, cell phone, and/or other communications device. If possible, the officer will attempt contact with the child.
- (h) Prepare necessary reports and complete appropriate forms. Officers shall write a report for all runaway cases.

The member responsible for follow-up shall:

- (a) Promptly notify the National Center for Missing and Exploited Children (NCMEC) when the child is missing from a foster care family or childcare institution (34 USC § 41308).
- (b) Attempt to obtain the most recent photograph if it has not been obtained previously and forward the photograph to the Utah BCI and enter the photograph into applicable missing person networks (34 USC § 41308).

317.6.1 RECOVERY OR RETURN OF A RUNAWAY

An officer assigned to the recovery or return of a runaway shall:

- (a) Verify that the located runaway is, in fact, the reported runaway.

Salt Lake City Police Department

SLCPD Policy Manual

SLCPD Policy Manual

Missing Children and Runaways

- i. If practicable, officers should respond to the location of the runaway to verify the return in-person, as well as inquire about where the runaway was, who they were with, and the motive for running away.
- (b) Secure medical and/or intervention services, if appropriate.
- (c) Arrange the return of the child to his or her legal guardian or the Juvenile Receiving Center in the case of a runaway from this department's jurisdiction or other jurisdiction within Utah, and who is not wanted on a pick up order or other law violation that qualifies for admittance to the Juvenile Detention Center.
- (d) Place the child in custody and transport him or her to the Juvenile Detention Center for admission in the case of a runaway from an out-of-state jurisdiction and for whom an NCIC runaway hit is verified.
- (e) Complete the appropriate supplemental reports and cancel all outstanding notifications, including the NCIC listing. If the NCIC entry was made by another jurisdiction, ensure an NCIC hit is sent to that jurisdiction by the Records Unit.

317.6.2 OPERATION HOME FREE

Operation Home Free is a cooperative program between law enforcement agencies and the Greyhound Bus Corporation aimed at reuniting runaway juveniles with their parents or legal guardians. Persons under the age of 18 identifying themselves to a law enforcement agency as a runaway or missing person and indicating a willingness to return unescorted will be issued a free Greyhound bus ticket.

When juveniles identify themselves to a member as a runaway and request a bus ticket home, the officer should:

- Contact the local law enforcement agency from the jurisdiction where the juvenile ran away from and verify that the juvenile has been reported as missing or a runaway and that a report is on file with that agency.
- Request the outside agency send a copy of their report.
- Make a report giving the name of the person who verified the juvenile as missing or runaway, the name of the juvenile, and the scheduled departure time from Salt Lake City and destination arrival time.
- Accompany the juvenile to the Greyhound Bus Depot.
- Forward a copy of the ticket request along with the report to the Special Victims Unit.

317.7 UNIDENTIFIED FOUND CHILDREN

Officers should take every reasonable action to identify and reunite an unidentified missing child with their custodial parent, guardian, or responsible party. If an Officer is unable to reunite an unidentified missing child with their caretaker, the Officer shall:

- (a) Notify their Sergeant of the actions they have taken
- (b) Notify the Division of Child and Family Services

Salt Lake City Police Department

SLCPD Policy Manual

SLCPD Policy Manual

Missing Children and Runaways

- (c) Transport the missing child to the Youth Receiving Center or the Christmas Box house, based on the child's age and needs
- (d) Document their actions in a general offense or supplemental report

317.8 REVISIONS

Enacted: March 5, 2018

Revised: December 17, 2018

Revised: November 6, 2019

Public Alerts

318.1 PURPOSE AND SCOPE

The purpose of this policy is to provide for the department's expectations regarding alerting the public to important information and soliciting public aid when appropriate.

318.2 POLICY

Public alerts may be employed using the Emergency Alert System (EAS), local radio, television, press organizations, and other groups to notify the public of incidents or enlist the aid of the public when the exchange of information may enhance the safety of the community. Various types of alerts may be available based on each situation and the alert system's individual criteria.

318.3 RESPONSIBILITIES

318.3.1 EMPLOYEE RESPONSIBILITIES

Employees of the Salt Lake City Police Department should notify their supervisor, Watch Commander or Investigations Division Supervisor as soon as practicable upon learning of a situation where public notification, a warning, or enlisting the help of the media and public could assist in locating a missing person, apprehending a dangerous person, or gathering information.

318.3.2 SUPERVISOR RESPONSIBILITIES

A supervisor apprised of the need for a public alert is responsible for making the appropriate notifications based on the circumstances of each situation. The supervisor shall promptly notify the Watch Commander when any public alert is necessary. The Watch Commander will notify the Public Information Officer and the appropriate Division Commander. The Division Commander will be responsible for notifying the appropriate Bureau Commander and Chief of Police, as necessary.

The supervisor in charge of the investigation to which the alert relates is responsible for the following:

- (a) Updating alerts
- (b) Canceling alerts
- (c) Ensuring all appropriate reports are completed

318.4 AMBER ALERTS

AMBER Alert is the recruitment of public assistance to locate an abducted child via a widespread media alert. Utilizing the assistance of local radio, television, and press affiliates the public will be notified of the circumstances of a child's abduction and how they can assist law enforcement in the child's recovery. The goal of the AMBER Alert program is the safe return of an abducted child by establishing an effective partnership between the community, the media, and law enforcement. The AMBER Alert Plan is tested every year on January 13th and August 26th.

The AMBER Alert does not preclude any law enforcement agency from utilizing or implementing in-house procedures, policies, or practices. However, AMBER Alerts are not to be used for a

Salt Lake City Police Department

SLCPD Policy Manual

SLCPD Policy Manual

Public Alerts

reported runaway or for custodial disputes where there is no credible threat of imminent danger or serious bodily injury or death to the child as set forth in Utah Code 53-10-1002. The department may consider issuing an Endangered Missing Advisory or A Child is Missing (ACIM) Alert to inform law enforcement and/or the public about cases that do not meet the criteria for an AMBER Alert. At the same time, each case must be appraised on its own merits, and a judgment call made quickly. A "best judgment" approach, based on the evidence, is appropriate and necessary.

318.4.1 CRITERIA

Upon receiving a report of a missing child, the department member shall determine whether:

- (a) The child has been taken, concealed, or detained without permission from an individual entitled to custody of the child.
- (b) The child is 17-years of age or younger.
- (c) There is a credible threat of imminent danger of serious bodily harm or death to the child.
- (d) There is sufficient information available to give out to the public that could assist in the safe recovery of the victim and/or the apprehension of a suspect.

An AMBER Alert will not be used if the answer is "no" to any of the above questions.

Upon a determination of the criteria above, the department member shall follow the procedures identified in [Salt Lake City Police Department Procedure Manual: 311.2 AMBER ALERT PROCEDURE](#).

318.5 BLUE ALERTS

318.5.1 CRITERIA

The four criteria required for a BLUE Alert are as follows:

- (a) A law enforcement officer has been killed, seriously injured, or assaulted with a deadly weapon by the suspect.
- (b) The suspect is an imminent threat to the public and other law enforcement personnel.
- (c) There is information available for the public about the suspect, the suspect's vehicle, and the vehicle tag.
- (d) Public dissemination of available information will help avert further harm or accelerate the apprehension of the suspect.

Upon a determination of any of the criteria above, the department member shall follow the procedures identified in [Salt Lake City Police Department Procedure Manual: 311.3 BLUE ALERT PROCEDURE](#)

318.6 ENDANGERED MISSING ADVISORY

The Endangered Missing Advisory is a system to rapidly disseminate information about a missing and/or endangered person to law enforcement agencies and the media. This may be a viable option for cases that do not meet the criteria for an Amber Alert or Silver Alert, but the individual

Salt Lake City Police Department

SLCPD Policy Manual

SLCPD Policy Manual

Public Alerts

is still considered at risk. The Endangered Missing Advisory is a voluntary partnership between law enforcement and local broadcasters for notifying the public about a missing and endangered person. The advisories are initiated solely by Utah law enforcement agencies.

318.6.1 CRITERIA

The following criteria must be met to initiate an Endangered Missing Advisory:

- (a) The person must be missing under unexplained or suspicious circumstances.
- (b) The person is believed to be in danger because of age, health, mental or physical disability, environment or weather conditions, in the company of a potentially dangerous person or some other factor that may put the person in peril.
- (c) There is information that could assist the public in the safe recovery of the missing person.

If the above criteria are met and the missing individual does not meet the criteria of an Amber Alert, or Silver Alert, department members shall follow the procedures identified in [Salt Lake City Police Department Procedure Manual: 311.4 ENDANGERED MISSING ADVISORY PROCEDURE](#)

318.7 A CHILD IS MISSING (ACIM) ALERT

A Child is Missing (ACIM) Alert is a free telemarketing service that allows the Salt Lake City Police Department to deliver a large volume of customized recorded phone messages (1,000 per minute) to the community in the area surrounding where a missing person was last seen (determined by zip code) in a short period of time. The call is an informational pre-recorded message about a missing person (of any age), along with investigating agency contact information.

The Salt Lake City Police Department may utilize the ACIM as a tool in cases of missing children, elderly citizens, disabled persons, and other vulnerable populations. It does not replace or preclude a thorough investigation and/or search by the responding officers. ACIM can be used with the Amber Alert or Silver Alert System.

318.7.1 CRITERIA

ACIM will be used only when officers have verified that an individual is missing and is verified as being a member of one of the vulnerable populations outlined above. Moreover, ACIM will only be used between 8:00 a.m. and 12:00 a.m. (midnight) unless there are special circumstances.

When a person is reported missing, the following criteria will be considered for determining the use of ACIM:

- I. JUVENILES
 - (a) All children 2 up to 18 years of age.
 - (b) The reporting person must be an adult family member, teacher, or other adult who is responsible for the child.
 - (c) ACIM is generally not used for habitual runaways.
- II. SENIOR CITIZENS

Salt Lake City Police Department

SLCPD Policy Manual

SLCPD Policy Manual

Public Alerts

- (a) The person must be 65 years of age or older or suffer from Alzheimer's disease/dementia.
 - (b) Circumstances surrounding the incident must be out of character for the individual.
- III. DISABLED PERSONS (MENTALLY/PHYSICALLY CHALLENGED)
- (a) There is no age stipulation for a disabled person. A person is considered disabled under ACIM guidelines if:
 - (a) The person has a physical or mental impairment which severely limits self-care.
 - (b) The person is disoriented or unable to respond to simple questions regarding personal information such as name and address.
 - (c) The person is dependent upon life-sustaining medication.
- IV. OTHER
- (a) The department member, with the approval of their immediate supervisor and/or Watch Commander, may take into account special circumstances that may influence using ACIM even if the person does not meet the above criteria. Circumstances include but are not limited to suspected foul play, imminent severe weather, etc.

318.8 SILVER ALERTS

The Silver Alert Notification System is a quick response system designed to issue and coordinate alerts following the report of a missing endangered adult ([Utah Code 53-10-702](#)). The system utilizes similar coordination as the Amber Alert System but does not include activation for the National Emergency Broadcast System and limits the use of the Department of Transportation highway signage to the geographical area where the missing person was last seen.

318.8.1 CRITERIA

Upon receiving a report of a missing adult, the department member shall determine whether the missing adult:

- (a) Is 60 years or older, or;
- (b) Officers reasonably believe that the missing person has a form of Dementia.

Upon a determination of any of the criteria above, the department member shall follow the procedures identified in [Salt Lake City Police Department Procedure Manual: 311.6 SILVER ALERT PROCEDURE](#)

"Dementia" is as defined by [Utah Code 53-10-702](#).

318.9 REVISIONS

Enacted: March 5, 2018

Revised: March 6, 2018

Salt Lake City Police Department

SLCPD Policy Manual

SLCPD Policy Manual

Public Alerts

Revised: June 29, 2020

Revised: October 3, 2023

Child and Dependent Adult Safety

319.1 PURPOSE AND SCOPE

This policy provides guidelines to ensure that children and dependent adults are not left without appropriate care in the event their caregiver or guardian is arrested or otherwise prevented from providing care due to actions taken by members of this department.

This policy does not address the actions to be taken during the course of a child abuse or dependent adult investigation. These are covered in the Child Abuse Policy and the Adult Abuse Policy.

319.2 POLICY

It is the policy of this department to mitigate, to the extent reasonably possible, the stressful experience individuals may have when their parent or caregiver is arrested.

319.3 PROCEDURES DURING AN ARREST

Whenever reasonably possible, officers should take reasonable steps to accomplish the arrest of a parent, guardian or caregiver out of the presence of his/her child or dependent adult. Removing children or dependent adults from the scene in advance of the arrest will generally ensure the best outcome for the individual.

319.3.1 AFTER AN ARREST

Officers should allow the arrestee reasonable time to arrange for care of children and dependent adults. Temporary placement with family or friends may be appropriate. However, any decision should give priority to a care solution that is in the best interest of the child or dependent adult. In such cases the following guidelines should be followed:

- (a) Allow the person reasonable time to arrange for the care of children and dependent adults with a responsible party, as appropriate.
- (b) Unless there is evidence to the contrary (e.g., signs of abuse, drug use, unsafe environment), officers should respect the parent or caregiver's judgment regarding arrangements for care. It is generally best if the child or dependent adult remains with relatives or family friends that he/she knows and trusts because familiarity with surroundings and consideration for comfort, emotional state and safety are important.
 1. Except when a court order exists limiting contact, the officer should attempt to locate and place children or dependent adults with the non-arrested parent, guardian or caregiver.
- (c) Provide for the immediate supervision of children or dependent adults until an appropriate caregiver arrives.
- (d) Notify Child Protective Services, if appropriate.

If children or dependent adults are at school or another known location outside the household at the time of arrest, the arresting officer should attempt to contact the school or other known location and inform the principal or appropriate responsible adult of the caregiver's arrest and of

Salt Lake City Police Department

SLCPD Policy Manual

SLCPD Policy Manual

Child and Dependent Adult Safety

the arrangements being made for the care of the arrestee's dependent. The result of such actions should be documented in the associated report.

If an arrestee is unable to resolve the care of any child or dependent adult through this process, a supervisor should be contacted to determine the appropriate steps to arrange for care. These steps may include additional telephone calls or contacting a local, county or state services agency.

319.3.2 REPORTING

Officers shall document in the ensuing report the arrangements made for the care of any child or dependent adult covered under this policy.

319.4 DEPENDENT WELFARE SERVICES

Whenever an arrestee is unwilling or incapable of arranging for the appropriate care of any child, the handling officer shall contact DCFS, following the same procedure outlined in the Child Abuse Policy and Procedure. [Salt Lake City Police Department Procedure Manual: 304.2 NOTIFICATION TO DCFS](#)

Whenever an arrestee is unwilling or incapable of arranging for the appropriate care of a dependent adult, the handling officer shall contact a department Victim Advocate through Dispatch for assistance.

Only when other reasonable options are exhausted should a child or dependent adult be taken into formal protective custody.

Under no circumstances should a child or dependent adult be left unattended or without appropriate care.

319.5 REVISIONS

Enacted: March 5, 2018

Victim and Witness Assistance

320.1 PURPOSE AND SCOPE

The purpose of this policy is to ensure that crime victims and witnesses receive appropriate assistance, that they are provided with information from government and private resources, and that the agency meets all related legal mandates.

320.2 POLICY

The Salt Lake City Police Department is committed to providing guidance and assistance to the victims and witnesses of crime. The employees of the Salt Lake City Police Department will show compassion and understanding for victims, will treat them with dignity and respect, and will make reasonable efforts to provide the support and information identified in this policy.

320.3 VICTIM ADVOCATES

Victim Advocates will be the main point of contact for victims requiring assistance or information from the Salt Lake City Police Department regarding crime victim resources. Victim Advocates shall be available 24 hours a day for victim assistance. Victims and all Salt Lake City Police Department employees may reach Victim Advocates at 801-580-7969 for a response. Advocate response may be any of the following methods:

- (a) Immediate response in person
- (b) Immediate response via telephone
- (c) Delayed response in person
- (d) Delayed response via telephone
- (e) Victim walk-in assistance (at the Public Safety Building, Family Justice Center, etc.)
- (f) Advocate outreach after a report has been filed
- (g) Scheduled home visit
- (h) Victim accompaniment for detective/follow-up interviews
- (i) Victim accompaniment when navigating the criminal justice system
- (j) Other appropriate responses as needed

Advocate staff will provide safety planning, crisis intervention, and other appropriate information and referrals as needed. Victim Advocates will help meet victims' immediate needs for food, shelter, clothing, etc.

For an immediate, in-person response, officers can request an advocate via dispatch. Dispatchers will contact advocates via the crisis line (801-580-7969). An advocate will respond as soon as possible, and provide dispatch with an estimated time of arrival.

The Victim Advocate Program will assign staff to cases through the RMS. Staff will attempt outreach to victims within 30 days of a case being assigned to their queue. Advocate staff will attempt at least 2 phone calls to reach the victim (if valid numbers are listed) and 1 email/letter

Salt Lake City Police Department

SLCPD Policy Manual

SLCPD Policy Manual

Victim and Witness Assistance

contact before submitting a case back. Advocate staff will coordinate with other agencies and/or conduct home visits as appropriate.

Advocate staff will address any safety concerns with the Coordinator or sworn staff to ensure Advocate safety. Advocates may also respond in pairs as needed.

320.4 VICTIM ASSISTANCE BY OFFICERS

Officers shall provide victims with the applicable victim information handouts. Officers shall obtain current contact information for victims at the time of reporting. Officers shall facilitate contact with a Victim Advocate when requested.

Officers shall provide Domestic Violence/Sexual Assault (blue) information cards to victims of:

- (a) Domestic violence
- (b) An offense against a child or vulnerable adult:
 - i. Child abuse and/or child abandonment (Utah Code 76-5-109)
 - ii. Commission of domestic violence in the presence of a child (Utah Code 76-5-109.1)
 - iii. Abuse or neglect of a child with a disability (Utah Code 76-5-110)
 - iv. Abuse, neglect, or exploitation of a vulnerable adult (Utah Code 76-5-111)
- (c) The commission or attempted commission of an offense described in Utah Code, Title 76, Chapter 5, Part 4, Sexual Offenses.

Officers shall refer victims to the Victim Advocate crisis line number on the card and note the case number on the card.

Officers shall ask victims for current contact information on each case and shall ensure the updated information is entered in the report. Each time a report is generated officers should not use entity auto-fill options without verifying the following information for each victim:

- (a) Current phone number
- (b) Current physical/mailing address
- (c) Email address
- (d) If the victim does not have the above information, collect contact information for a friend or family member who can contact the victim. Provide that individual's name and relationship to the victim.

320.4.1 JAIL RELEASE AGREEMENTS

When a person is arrested for a qualifying offense and booked into jail, a Salt Lake City Police Department Jail Release Agreement will be issued to the arrested person. The issuing officer shall explain the form to the arrested person and make sure the form is filled out completely. A copy will be given to the arrested person and to the victim.

A qualifying offense includes (Utah Code 78B-7-801):

Salt Lake City Police Department

SLCPD Policy Manual

SLCPD Policy Manual

Victim and Witness Assistance

- (a) Domestic violence
- (b) An offense against a child or vulnerable adult:
 - i. Child abuse and/or child abandonment (Utah Code 76-5-109)
 - ii. Commission of domestic violence in the presence of a child (Utah Code 76-5-114)
 - iii. Abuse or neglect of a child with a disability (Utah Code 76-5-110)
 - iv. Abuse, neglect, or exploitation of a vulnerable adult (Utah Code 76-5-111)
 - v. Sexual battery (76-9-702.1)
- (c) The commission or attempted commission of an offense described in Utah Code, Title 76, Chapter 5, Part 4, Sexual Offenses.

The Jail Release Agreement will notify the arrested person that they shall:

- (a) Have no personal contact with the alleged victim;
- (b) Not threaten or harass the alleged victim; and
- (c) Not knowingly enter onto the premises of the alleged victim's residence or any premises temporarily occupied by the alleged victim.

Violating the Jail Release Agreement from the jail is a class B misdemeanor. Violation of the Jail Release Agreement after being released from jail would be a class A misdemeanor if the original booking charge was a misdemeanor, or a 3rd-degree felony if the original booking charge was a felony.

If an officer becomes aware that an arrested person has violated a Jail Release Agreement while the person is still in jail, the officer shall notify jail personnel that a violation of the Jail Release Agreement has occurred from the jail. The officer shall respond to the jail and add the charge of "Violation of a Jail Release Agreement" (Utah Code 78B-7-806), to the original charges.

A copy of the Jail Release Agreement shall be turned into records.

320.4.2 JAIL RELEASE AGREEMENT WAIVER

Subsequent to an arrest for any qualifying offense, an alleged victim, who is not a minor, may waive in writing any or all of the release conditions listed under (a) and (c). Upon waiver, those release conditions do not apply to the alleged perpetrator.

If a victim, who is not a minor, wishes to waive parts (a) and/or (c) of the Jail Release Agreement, an officer will provide the victim with a Salt Lake City Police Department Notice of Right to Waiver of Jail Release Agreement form. The officer shall have the victim check which parts of the Jail Release Agreement they wish to waive and then have them sign and date the form. The officer will write the victim's name and the arrested person's name on the form along with their name and ID number.

A copy of the form shall be given to the victim and the original shall be taken immediately to the Records Unit.

Salt Lake City Police Department

SLCPD Policy Manual

SLCPD Policy Manual

Victim and Witness Assistance

320.4.3 RELEASE NOTIFICATION

When a person is released from the jail after an arrest in a domestic violence case, the jail will notify dispatch of the release.

Dispatch will retrieve victim contact information from the initial reporting officer's report.

Dispatch will attempt to notify the victim via phone of the release. If dispatch is unable to make notification, the dispatcher will assign an officer to notify the victim of the release. The officer will make a reasonable effort to contact the victim and complete a supplemental report that will document what action the officer took.

The officer making the release notification will write a supplementary report to the original case indicating the result of the notification effort. If unable to make contact with the victim, the officer will notify dispatch and leave a business card with the jail release notification information.

320.5 VICTIM INFORMATION HANDOUTS

The Support Division Commander or designee shall ensure that victim information handouts are available and current. Handouts will include appropriate resources, contact information for the Victim Advocates, legally mandated information, and notification of victims' rights. Victim Advocates will work with the Support Division Commander or designee to ensure victim information handouts are current and contain appropriate information and resources. These handouts will include information related to:

- (a) Contact information for the Victim Advocate Program
- (b) Governmental and community resources for victims of crime
- (c) Notification of victims' rights
- (d) Information about reparations and restitution
- (e) Other appropriate information as needed

320.6 VICTIM CENTERED RESPONSES

Every effort shall be taken to ensure that victims will receive assistance in an appropriate manner. Officers shall use trauma-informed practices when interviewing and interacting with victims. Staff will use translation services and/or documents to reach out to victims in their primary language.

Officers shall receive trauma-informed training during the in-house academy, and ongoing training as needed. Officers shall receive training on the Victim Advocate Program during the in-house academy, as well as ongoing training as needed.

320.7 REVISIONS

Enacted: March 5, 2018

Hate Crimes

321.1 PURPOSE AND SCOPE

This department recognizes and places a high priority on any individual's constitutional right to the lawful expression of free speech or other recognized rights secured by the Constitution or laws of the state or by the Constitution or laws of the United States. When such rights are infringed upon by violence, threats or other harassment, this department will utilize all available resources to see that justice is served under the law. This policy has been developed to provide members of the Department with guidelines for identifying and investigating incidents and crimes that may be motivated by hatred or other bias.

321.1.1 FEDERAL JURISDICTION

The federal government also has the power to investigate and prosecute bias-motivated violence by providing the U.S. Department of Justice with jurisdiction over crimes of violence where the perpetrator has selected the victim because of the person's actual or perceived race, color, ethnicity, religion, national origin, gender, sexual orientation, gender identity, gender expression or disability (18 USC § 249).

321.2 DEFINITIONS

Intimidate or terrorize - Means an act which causes the person to fear for his/her physical safety or damages the property of that person or another. The act must be accompanied with the intent to cause or has the effect of causing a person to reasonably fear to freely exercise or enjoy any right secured by the Constitution or laws of the state or by the Constitution or laws of the United States (Utah Code 76-3-203.3(3)).

321.3 CRIMINAL STATUTES

Utah Code 76-3-203.3 (Penalty for Hate Crimes), Utah Code 76-3-203.4 (Hate Crimes - Aggravating Factors), and Utah Code 76-3-203.14 (Victim Targeting Penalty Enhancement).

321.4 PREVENTING AND PREPARING FOR LIKELY HATE CRIMES

While it is recognized that not all crime can be prevented, this department is committed to taking a proactive approach to preventing and preparing for likely hate crimes by making an affirmative effort to establish contact with persons and groups within the community who are likely targets of hate crimes to form and cooperate with prevention and response networks.

321.5 PROCEDURE FOR INVESTIGATING HATE CRIMES

Whenever any member of the Department receives a report of a suspected hate crime or other activity that reasonably appears to involve a potential hate crime, the following should occur:

- (a) Officer(s) will be assigned to contact the victim, witness, or reporting party to investigate the matter further as circumstances may dictate.
- (b) A supervisor should be notified of the circumstances as soon as practical.

Salt Lake City Police Department

SLCPD Policy Manual

SLCPD Policy Manual

Hate Crimes

- (c) Once "in progress" aspects of any such situation have been stabilized (e.g., treatment of victims, apprehension of present suspects), the assigned officer(s) will take all reasonable steps to preserve available evidence that may tend to establish that a hate crime was involved.
- (d) The assigned officer(s) will interview available witnesses, victims, and others to determine what circumstances if any, indicate that the situation may involve a hate crime.
- (e) Proper notification procedures shall be followed. [Salt Lake City Police Department Procedure Manual: 305.2 HATE CRIME NOTIFICATION PROCEDURE](#)
- (f) Proper reporting procedures shall be followed. [Salt Lake City Police Department Procedure Manual: 305.3 HATE CRIME REPORT PREPARATION PROCEDURE](#)

321.5.1 INVESTIGATIONS DIVISION RESPONSIBILITY

Cases will be assigned to detectives based on the reported primary offense for follow-up investigation. The assigned detective will be responsible for following up on the reported hate crime as follows:

- (a) The assigned follow-up detective will review each case for a motive. If the hate crime classification appears valid, the detective will continue to work on the case and the classification will not change; the detective shall also be responsible for properly indicating the report's bias code.
- (b) If the hate crime classification appears to be inappropriate for the crime, the Detective Sergeant will review the case with the Division administration of the officer making the report. If the case is reclassified because it is determined a hate crime did not occur, the follow-up detective will note in a supplementary report that the classification has been changed and detail the reasons for the change.
- (c) Coordinate further investigation with the District Attorney and other appropriate law enforcement agencies, as appropriate.
- (d) Maintain contact with the victim(s) and other involved individuals as needed.

321.5.2 SALT LAKE INFORMATION CENTER (SLIC) RESPONSIBILITY

All reports of hate crimes will also be routed to the SLIC. The SLIC is responsible for maintaining files and statistical data on suspected hate crimes.

321.6 REVISIONS

Enacted: March 5, 2018

Revised: May 23, 2022

Standards of Conduct

322.1 PURPOSE AND SCOPE

This policy establishes standards of conduct that are consistent with the values and mission of the Salt Lake City Police Department and are expected of all department members. The standards contained in this policy are not intended to be an exhaustive list of requirements and prohibitions but they do identify many of the important matters concerning conduct. In addition to the provisions of this policy, members are subject to all other provisions contained in this manual as well as any additional guidance on conduct that may be disseminated by this department or the member's supervisors.

322.2 POLICY

The continued employment or appointment of every member of the Salt Lake City Police Department shall be based on conduct that reasonably conforms to the guidelines set forth herein. Failure to meet the guidelines set forth in this policy, whether on- or off-duty, may be cause for disciplinary action.

322.3 DIRECTIVES AND ORDERS

Members shall comply with lawful directives and orders from any department supervisor or person in a position of authority.

When disagreements between management and employees occur, management has the right to expect employees to follow the accepted labor principle of 'obey now and grieve later'. When a member is capable of performing a task or complying with a lawful order or written directive, but refuses, it is considered insubordination.

322.3.1 UNLAWFUL OR CONFLICTING ORDERS

Supervisors shall not knowingly issue orders or directives that, if carried out, would result in a violation of any law or department policy. Supervisors should not issue orders that conflict with any previous order without making reasonable clarification that the new order is intended to countermand the earlier order.

No member is required to obey any order that appears to be in direct conflict with any federal law, state law or local ordinance. Following a known unlawful order is not a defense and does not relieve the member from criminal or civil prosecution or administrative discipline. If the legality of an order is in doubt, the affected member shall ask the issuing supervisor to clarify the order or shall confer with a higher authority. The responsibility for refusal to obey rests with the member, who shall subsequently be required to justify the refusal.

Unless it would jeopardize the safety of any individual, members who are presented with a lawful order that is in conflict with a previous lawful order, department policy or other directive shall respectfully inform the issuing supervisor of the conflict. The issuing supervisor is responsible for either resolving the conflict or clarifying that the lawful order is intended to countermand the previous lawful order or directive, in which case the member is obliged to comply. Members who

Salt Lake City Police Department

SLCPD Policy Manual

SLCPD Policy Manual

Standards of Conduct

are compelled to follow a conflicting lawful order after having given the issuing supervisor the opportunity to correct the conflict, will not be held accountable for disobedience of the lawful order or directive that was initially issued.

The person countermanding the original order should notify the person issuing the original order, indicating the action taken and the reason.

322.3.2 SUPERVISOR RESPONSIBILITIES

Supervisors and managers are required to follow all policies and procedures and may be subject to discipline for:

- (a) Failure to be reasonably aware of the performance of their subordinates or to provide appropriate guidance and control.
- (b) Failure to promptly and fully report any known misconduct of a member to his/her immediate supervisor or to document such misconduct appropriately or as required by policy.
- (c) Directing a subordinate to violate a policy or directive, acquiesce to such a violation, or are indifferent to any such violation by a subordinate.
- (d) The unequal or disparate exercise of authority on the part of a supervisor toward any member for malicious or other improper purpose.

322.4 CAUSES FOR DISCIPLINE

The following are illustrative of causes for disciplinary action. This list is not intended to cover every possible type of misconduct and does not preclude the recommendation of disciplinary action for violation of other rules, standards, ethics and specific action or inaction that is detrimental to efficient department service.

322.4.1 LAWS, RULES AND ORDERS

- (a) Violation of, or ordering or instructing a subordinate to violate any policy, procedure, rule, order, directive, requirement or failure to follow instructions contained in department or City manuals.
- (b) Disobedience of any legal directive or order issued by any department member of a higher rank.
- (c) Violation of federal, state, local or administrative laws, rules or regulations.

322.4.2 ETHICS

- (a) Using or disclosing one's status as a member of the Salt Lake City Police Department in any way that could reasonably be perceived as an attempt to gain influence or authority for nondepartment business or activity.
- (b) The wrongful or unlawful exercise of authority on the part of any member for malicious purpose, personal gain, willful deceit or any other improper purpose.

Salt Lake City Police Department

SLCPD Policy Manual

SLCPD Policy Manual

Standards of Conduct

- (c) The receipt or acceptance of a reward, fee or gift from any person for service incident to the performance of the member's duties (lawful subpoena fees and authorized work permits excepted).
- (d) Acceptance of any personal gift if it tends to influence the discharge of official duties, or if it involves any governmental action involving the donor.
- (e) Offer or acceptance of a bribe or gratuity.
- (f) Misappropriation or misuse of public funds, property, personnel or services.
- (g) Posting bail or recommending attorneys, bondsmen, or bail brokers to any person, except for immediate family.
- (h) Any other failure to abide by the standards of ethical conduct.

322.4.3 DISCRIMINATION, OPPRESSION OR FAVORITISM

Discriminating against, oppressing or providing favoritism to any person because of age, race, color, creed, religion, sex, sexual orientation, gender identity or expression, national origin, ancestry, marital status, physical or mental disability, medical condition or other classification protected by law, or intentionally and unlawfully denying or impeding another in the exercise or enjoyment of any right, privilege, power, or immunity.

322.4.4 RELATIONSHIPS

- (a) Unwelcome solicitation of a personal or sexual relationship while on duty or through the use of one's official capacity.
- (b) Engaging in on duty sexual activity including, but not limited to, sexual intercourse, excessive displays of public affection or other sexual contact.
- (c) Establishing or maintaining an inappropriate personal or financial relationship, as a result of an investigation, with a known victim, witness, suspect or defendant while a case is being investigated or prosecuted, or as a direct result of any official contact.
- (d) Associating with or joining a criminal gang, organized crime and/or criminal syndicate when the member knows or reasonably should know of the criminal nature of the organization. This includes any organization involved in a definable criminal activity or enterprise, except as specifically directed and authorized by this department.
- (e) Associating on a personal, rather than official basis with persons who demonstrate recurring involvement in serious violations of state or federal laws after the member knows, or reasonably should know of such criminal activities, except as specifically directed and authorized by this department.
 - i. Any personal association of this nature, not specifically directed or authorized by this department, shall be reported to a member's Division Commander as soon as practicable.

322.4.5 ATTENDANCE

- (a) Leaving the job to which the member is assigned without proper permission and approval.

Salt Lake City Police Department

SLCPD Policy Manual

SLCPD Policy Manual

Standards of Conduct

- (b) Unexcused or unauthorized absence or tardiness.
- (c) Excessive absenteeism or abuse of leave privileges.
- (d) Failure to report to work or to place of assignment at time specified and fully prepared to perform duties without reasonable excuse.

322.4.6 UNAUTHORIZED ACCESS, DISCLOSURE OR USE

- (a) Unauthorized and inappropriate intentional release of confidential or protected information, materials, data, forms or reports obtained as a result of the member's position with this department.
- (b) Disclosing to any unauthorized person any active investigation information.
- (c) The use of any information, photograph, video or other recording obtained or accessed as a result of employment or appointment to this department for personal or financial gain or without the express authorization of the Chief of Police or the authorized designee.
- (d) Loaning, selling, allowing unauthorized use, giving away or appropriating any Salt Lake City Police Department badge, uniform, identification card or department property for personal use, personal gain or any other improper or unauthorized use or purpose.
- (e) Using department resources in association with any portion of an independent civil action. These resources include, but are not limited to, personnel, vehicles, equipment and nonsubpoenaed records.

322.4.7 EFFICIENCY

- (a) Neglect of duty.
- (b) Unsatisfactory work performance including, but not limited to, failure, incompetence, inefficiency or delay in performing and/or carrying out proper orders, work assignments or the instructions of supervisors without a reasonable and bona fide excuse.
- (c) Concealing, attempting to conceal, removing or destroying defective or incompetent work.
- (d) Unauthorized sleeping during on-duty time or assignments.
- (e) Failure to notify the Department within 72 hours of any change in residence address and/or contact telephone numbers.

322.4.8 PERFORMANCE

- (a) Failure to disclose or misrepresenting material facts, or making any false or misleading statement on any application, examination form, or other official document, report or form, or during the course of any work related investigation.
- (b) The falsification of any work-related records, making misleading entries or statements with the intent to deceive or the willful and unauthorized removal, alteration, destruction and/or mutilation of any department record, public record, book, paper or document.

Salt Lake City Police Department

SLCPD Policy Manual

SLCPD Policy Manual

Standards of Conduct

- (c) Failure to participate in, or giving false or misleading statements, or misrepresenting or omitting material information to a supervisor or other person in a position of authority, in connection with any investigation or in the reporting of any department related business.
- (d) Being untruthful or knowingly making false, misleading or malicious statements that are reasonably calculated to harm the reputation, authority or official standing of this department or its members.
- (e) Disparaging remarks or conduct concerning duly constituted authority to the extent that such conduct disrupts the efficiency of this department or subverts the good order, efficiency and discipline of this department or that would tend to discredit any of its members.
- (f) Unlawful gambling or unlawful betting at any time or any place. Legal gambling or betting under any of the following conditions:
 - i. While on department premises.
 - ii. At any work site, while on duty or while in uniform, or while using any department equipment or system.
 - iii. Gambling activity undertaken as part of an officer's official duties and with the express knowledge and permission of a direct supervisor is exempt from this prohibition.
- (g) Improper political activity including:
 - (a) Unauthorized attendance while on duty at official legislative or political sessions.
 - (b) Solicitations, speeches or distribution of campaign literature for or against any political candidate or position while on-duty or, on department property or while in any way representing him/herself as a member of this department, except as expressly authorized by City policy, the collective bargaining agreement, or the Chief of Police.
 - (c) Use of City equipment (e.g., computers, phones, fax machines, copy machines, etc.), any document bearing Department insignia, or City-owned or leased space for campaign purposes.
 - (d) Use of City vehicles for any campaign activity, including transporting political signs.
- (h) Engaging in political activities during assigned working hours except as expressly authorized by City policy, the collective bargaining agreement, or the Chief of Police.
- (i) Any act on or off-duty that brings discredit to this department.

322.4.9 CONDUCT

- (a) Failure of any member to promptly and fully report activities on his/her part or the part of any other member where such activities may result in criminal prosecution or discipline under this policy or resulted in contact with any other law enforcement agency.
- (b) Unreasonable and unwarranted force to a person encountered or a person under arrest.

Salt Lake City Police Department

SLCPD Policy Manual

SLCPD Policy Manual

Standards of Conduct

- (c) Exceeding lawful peace officer powers by unreasonable, unlawful or excessive conduct.
- (d) Unauthorized or unlawful fighting, threatening or attempting to inflict unlawful bodily harm on another.
- (e) Discourteous, disrespectful or discriminatory treatment of any member of the public or any member of this department or the City.
- (f) Patronizing an establishment that is licensed as a bar while on-duty or in uniform.
 - i. With the approval of the responsible Division Commander or designee, exceptions include special assignments where patronizing these establishments on-duty is necessary (i.e., Narcotics Unit, Organized Crime Unit, etc.).
- (g) Use of obscene, indecent, profane or derogatory language while on-duty or in uniform.
- (h) Criminal, dishonest, or disgraceful conduct, whether on- or off-duty, that adversely affects the member's relationship with this department.
- (i) Unauthorized possession of, loss of, or damage to department property or the property of others, or endangering it through carelessness or maliciousness.
- (j) Attempted or actual theft of department property; misappropriation or misuse of public funds, property, personnel or the services or property of others; unauthorized removal or possession of department property or the property of another person.
- (k) Activity that is incompatible with a member's conditions of employment or appointment as established by law or that violates a provision of any collective bargaining agreement to include fraud in securing the appointment or hire.
- (l) Any other on or off-duty conduct which any member knows or reasonably should know is unbecoming a member of this department, is contrary to good order, efficiency or morale, or tends to reflect unfavorably upon this department or its members.

322.4.10 SAFETY

- (a) Failure to observe or violating department safety standards or safe working practices.
- (b) Failure to maintain current licenses or certifications required for the assignment or position (e.g., driver's license).
- (c) Failure to maintain good physical condition sufficient to adequately and safely perform law enforcement duties.
- (d) Unsafe firearm or other dangerous weapon handling to include loading or unloading firearms in an unsafe manner, either on- or off-duty.
- (e) Carrying, while on the premises of the work place, any firearm or other lethal weapon that is not authorized by the member's appointing authority.
- (f) Unsafe or improper driving habits or actions in the course of employment or appointment.
- (g) Any personal action contributing to a preventable traffic collision.

Salt Lake City Police Department

SLCPD Policy Manual

SLCPD Policy Manual

Standards of Conduct

- (h) Concealing or knowingly failing to report any on-the-job or work-related accident or injury as soon as practicable but within 24 hours.

322.4.11 INTOXICANTS

- (a) Reporting for work or being at work while intoxicated or when the member's ability to perform assigned duties is impaired due to the use of alcohol, medication or drugs, whether legal, prescribed or illegal.
- (b) Possession or use of alcohol at any work site or while on-duty, except as authorized in the performance of an official assignment. A member who is authorized to consume alcohol is not permitted to do so to such a degree that it may impair on-duty performance.
- (c) Unauthorized possession, use of, or attempting to bring a controlled substance, illegal drug or non-prescribed medication to any work site.

322.4 GENERAL STANDARDS

Members shall conduct themselves, whether on- or off-duty, in accordance with the United States and Utah Constitutions and all applicable laws, ordinances and rules enacted or established pursuant to legal authority.

Members shall familiarize themselves with policies and procedures and are responsible for compliance with each. Members should seek clarification and guidance from supervisors in the event of any perceived ambiguity or uncertainty.

Discipline may be initiated for any good cause; this policy is not intended to cover every possible type of misconduct.

322.6 COURTESY IN CONTACTS

Personnel should, when possible, introduce themselves upon initial contact with the public by name, rank, and Department. This includes when responding to calls for service or any other appropriate public contact.

When interacting with a member of the public over the telephone, personnel shall maintain a courteous and professional demeanor, and identify themselves with name, rank, and Department assignment or unit.

When placing business calls or calls to the homes of other members, employees shall identify themselves by name and Department.

322.7 OBLIGATION TO SUPPORT AND RESPECT COWORKERS

Employees shall perform their duties in a cooperative and supportive manner. They shall assist and protect each other in the performance of their lawful duties. Employees shall be courteous, civil, and otherwise act with respect toward one another. Employees should address one another by use of their titles and will not use first names or nicknames in front of the public.

Salt Lake City Police Department

SLCPD Policy Manual

SLCPD Policy Manual

Standards of Conduct

322.7.1 COURTEOUS AND RESPECTFUL BEHAVIOR TOWARD POSITIONS OF AUTHORITY

Employees shall display courtesy and respect in words, deeds, gestures, and actions toward personnel holding higher levels of authority.

322.7.2 COURTEOUS AND RESPECTFUL BEHAVIOR TOWARD SUBORDINATE RANKS

Supervisors shall treat subordinates with the same courtesy and respect that is required of subordinates toward supervisors. Criticism of an employee or of an employee's performance will be made directly to the subordinate and should be made in a private setting.

Because supervisors are the Command Staff's representatives, they will be held to a higher standard in this area. Supervisors are expected to set a positive example for others to follow.

322.8 REVISIONS

Enacted: March 5, 2018

Revised: September 25, 2018

Information Technology Use

323.1 PURPOSE AND SCOPE

The purpose of this policy is to provide guidelines for the proper use of department information technology resources, including computers, electronic devices, hardware, software and systems.

323.1.1 DEFINITIONS

Definitions related to this policy include:

Computer system - All computers (on-site and portable), electronic devices, hardware, software, and resources owned, leased, rented or licensed by the Salt Lake City Police Department that are provided for official use by its members. This includes all access to, and use of, Internet Service Providers (ISP) or other service providers provided by or through the Department or department funding.

Hardware - Includes, but is not limited to, computers, computer terminals, network equipment, electronic devices, telephones, including cellular and satellite, pagers, modems or any other tangible computer device generally understood to comprise hardware.

Software - Includes, but is not limited to, all computer programs, systems and applications, including shareware. This does not include files created by the individual user.

Temporary file, permanent file or file - Any electronic document, information or data residing or located, in whole or in part, on the system including, but not limited to, spreadsheets, calendar entries, appointments, tasks, notes, letters, reports, messages, photographs or videos.

323.2 POLICY

It is the policy of the Salt Lake City Police Department that members shall use information technology resources, including computers, software and systems, that are issued or maintained by the Department in a professional manner and in accordance with this policy.

323.3 PRIVACY EXPECTATION

Members forfeit any expectation of privacy with regard to emails, texts or anything published, shared, transmitted or maintained through file-sharing software or any Internet site that is accessed, transmitted, received or reviewed on any department computer system.

The Department reserves the right to access, audit and disclose, for whatever reason, any message, including attachments, and any information accessed, transmitted, received or reviewed over any technology that is issued or maintained by the Department, including the department email system, computer network and/or any information placed into storage on any department system or device. This includes records of all keystrokes or Web-browsing history made at any department computer or over any department network. The fact that access to a database, service or website requires a username or password will not create an expectation of privacy if it is accessed through department computers, electronic devices or networks.

Salt Lake City Police Department

SLCPD Policy Manual

SLCPD Policy Manual

Information Technology Use

The Department may not require a member to disclose a username and/or password that allows access to the member's personal Internet accounts, except as may be provided in Utah Code 34-48-201.

323.4 RESTRICTED USE

Members shall not access computers, devices, software or systems for which they have not received prior authorization or the required training. Members shall immediately report unauthorized access or use of computers, devices, software or systems by another member to their supervisors or Watch Commanders.

Members shall not use another person's access passwords, logon information and other individual security data, protocols and procedures.

323.4.1 SOFTWARE

Members shall not copy or duplicate any copyrighted or licensed software except for a single copy for backup purposes in accordance with the software company's copyright and license agreement.

To reduce the risk of a computer virus or malicious software, members shall not install any unlicensed or unauthorized software on any department computer or any shared network drive. Members shall not install personal copies of any software onto any department computer.

When related to criminal investigations, software program files may be downloaded only with the approval of the information systems technology (IT) staff and with the authorization of the Chief of Police or the authorized designee.

No member shall knowingly make, acquire or use unauthorized copies of computer software that is not licensed to the Department while on department premises, computer systems or electronic devices. Such unauthorized use of software exposes the Department and involved members to severe civil and criminal penalties.

Introduction of software by members should only occur as part of the automated maintenance or update process of department- or City-approved or installed programs by the original manufacturer, producer or developer of the software.

Any other introduction of software requires prior authorization from IT staff and a full scan for malicious attachments.

323.4.2 HARDWARE

Access to technology resources provided by or through the Department shall be strictly limited to authorized department members. Data stored on or available through department computer systems shall only be accessed by authorized members who are engaged in an active investigation or assisting in an active investigation, or who otherwise have a legitimate law enforcement or department-related purpose to access such data. Any exceptions to this policy must be approved by a supervisor.

Salt Lake City Police Department

SLCPD Policy Manual

SLCPD Policy Manual

Information Technology Use

323.4.3 INTERNET USE

Internet access provided by or through the Department shall be limited to department-related activities. Internet sites containing information that is not appropriate or applicable to department use and which shall not be intentionally accessed include, but are not limited to, adult forums, pornography, gambling, and similar or related Internet sites. Certain exceptions may be permitted with the express approval of a supervisor as a function of a member's assignment.

Downloaded information shall be limited to messages, mail, and data files.

Exceptions to the above include the following:

- Infrequent personal use is permissible if limited in scope and frequency, if in conformance with other elements of this policy, and if not connected with a profit-making business enterprise or the promotion of any product, service, or cause that has not received prior approval.

323.4.4 OFF-DUTY USE

Members may use technology resources provided by the Department while off duty, as long as all elements of this policy are still followed.

Refer to the Personal Communication Devices Policy for guidelines regarding off-duty use of personally owned technology.

323.5 PROTECTION OF AGENCY SYSTEMS AND FILES

All members have a duty to protect the computer system and related systems and devices from physical and environmental damage and are responsible for the correct use, operation, care and maintenance of the computer system.

Members shall ensure department computers and access terminals are not viewable by persons who are not authorized users. Computers and terminals should be secured, users logged off and password protections enabled whenever the user is not present. Access passwords, logon information and other individual security data, protocols and procedures are confidential information and are not to be shared. Password length, format, structure and content shall meet the prescribed standards required by the computer system or as directed by a supervisor and shall be changed at intervals as directed by IT staff or a supervisor.

It is prohibited for a member to allow an unauthorized user to access the computer system at any time or for any reason. Members shall promptly report any unauthorized access to the computer system or suspected intrusion from outside sources (including the Internet) to a supervisor.

323.6 INSPECTION OR REVIEW

A supervisor or the authorized designee has the express authority to inspect or review the computer system, all temporary or permanent files, related electronic systems or devices, and any contents thereof, whether such inspection or review is in the ordinary course of his/her supervisory duties or based on cause.

Salt Lake City Police Department

SLCPD Policy Manual

SLCPD Policy Manual

Information Technology Use

Reasons for inspection or review may include, but are not limited to, computer system malfunctions, problems or general computer system failure, a lawsuit against the Department involving one of its members or a member's duties, an alleged or suspected violation of any department policy, a request for disclosure of data, or a need to perform or provide a service.

The IT staff may extract download, or otherwise obtain any and all temporary or permanent files residing or located in or on the department computer system when requested by a supervisor or during the course of regular duties that require such information.

323.7 REVISIONS

Enacted: March 5, 2018

Report Preparation

324.1 PURPOSE AND SCOPE

Report preparation is a major part of each officer's job. The purpose of reports is to document sufficient information to refresh the officer's memory and to provide sufficient information for follow-up investigation and successful prosecution. Report writing is the subject of substantial formalized training and on-the-job training.

324.1.1 REPORT PREPARATION

Employees should ensure that reports are sufficiently detailed for their purpose and free from errors prior to submission. It is the responsibility of the assigned employee to complete and submit all reports taken during the shift before going off-duty unless permission to hold the report has been approved by a supervisor. Generally, reports requiring prompt follow-up action on active leads, or arrest reports where the suspect remains in custody should not be held. Investigative personnel shall complete follow-up reports to assigned cases as information becomes available, and complete the clearance block of reports when closed, so that proper documentation can be maintained.

Handwritten reports must be prepared legibly. If the report is not legible, the submitting employee will be required by the reviewing supervisor to promptly make corrections and resubmit the report. Employees who dictate reports shall use appropriate grammar, as content is not the responsibility of the typist. Employees who generate reports on computers are subject to all requirements of this policy.

All reports shall accurately reflect the identity of the persons involved, all pertinent information seen, heard or assimilated by any other sense, and any actions taken. Employees shall not suppress, conceal or distort the facts of any reported incident, nor shall any employee make a false report orally or in writing. Generally, the reporting employee's opinions should not be included in reports unless specifically identified as such.

324.1.2 INFORMATION REQUIRED IN REPORTS

A police report is a public document and must contain the following information, if known:

- (a) The date, time, location, and nature of the complaint, the incident or offense.
- (b) The names of victims.
- (c) The nature or general scope of the agency's initial actions taken in response to the incident.
- (d) The general nature of any injuries or estimate of damages sustained in the incident.
- (e) The name, address and other identifying information about any person arrested or charged in connection with the incident.
- (f) The identity of public safety personnel, except undercover personnel, involved in responding to the initial incident.

Salt Lake City Police Department

SLCPD Policy Manual

SLCPD Policy Manual

Report Preparation

324.1.3 OFFENSES REQUIRING SEPARATE CASE NUMBERS

The following list designates when a separate case number must be obtained:

- (a) When an individual is arrested on charges (includes being issued a misdemeanor citation) and booked on a warrant(s) during the same incident.
 - i. When booking a subject into jail for charges and warrants, officers shall get an on-view case number for the warrants served at the jail. Officers will list the warrant(s) in the on-view case, link the on-view warrant case to the case the subject was booked on charges for, and link the on-view warrant case to the Salt Lake City Police Department case(s) that the warrant(s) originated from, if applicable. This will be done separately for each subject arrested.
- (b) There are multiple victims of theft (i.e., car prowls/strips with multiple vehicles in a parking lot).
- (c) Forged checks; each check to be listed in a separate report unless all forged checks were written by the same offender at the same address/location.
- (d) When a single subject is the victim of one offense, and the suspect or arrested person of another offense during the same incident.

324.2 REQUIRED REPORTING

Written reports are required in all of the following situations in the Department-approved report writing system and/or on the appropriate Department-approved form unless otherwise approved by a supervisor:

- (a) When a crime has been committed
- (b) When an arrest is made
- (c) Any use of force against any person by a member of this department (see the Use of Force Policy)
- (d) Whenever an officer takes any police action
- (e) Any firearm discharge (see the Firearms Policy)
- (f) When there is a death or probable death
- (g) When an officer responds to a medical assist or injured person call
- (h) Any time a person is reported missing (see the Missing Persons and Missing Children Policies)
- (i) Any time a crime lab technician responds to the scene of an incident
- (j) Any time evidence and/or property is booked into evidence (requires a General Offense report)
- (k) When there is additional or new information ascertained in reference to a previous case
- (l) When facts of the current incident may be helpful in a future investigation
- (m) Whenever there is any indication that the facts of an incident may tend to embarrass the Department

Salt Lake City Police Department

SLCPD Policy Manual

SLCPD Policy Manual

Report Preparation

- (n) Any traffic collision that meets the Department's reporting requirements (see the Traffic Collision Reporting Policy)
- (o) Any time a vehicle is impounded
- (p) Any time a child is taken into protective custody
- (q) Suspicious incidents that may place the public or others at risk
- (r) Whenever the employee believes the circumstances should be documented or at the direction of a supervisor
- (s) Other situations covered by separate policies:
 - i. Use of Force Policy
 - ii. Domestic Violence Policy
 - iii. Child Abuse Policy
 - iv. Adult Abuse Policy
 - v. Hate Crimes Policy
 - vi. Suspicious Activity Reports Policy

324.2.1 NO CASE CLASSIFICATION

When an officer determines an incident should be "no case" reported, the dispatcher will be notified. The officer should briefly indicate the reason for the no case report and provide the appropriate NCIC classification code. The no case report classification may be used when:

- (a) The complainant, incident, or reported address cannot be located, and other attempts to locate a complainant failed.
- (b) The complainant has canceled the request for assistance prior to the arrival of the officer(s) (except on complaints of domestic violence - officers will continue to the scene).
- (c) No police action was required.
- (d) A traffic citation suffices to resolve the problem.
- (e) The situation is civil and all known facts indicate no further complaints will be forthcoming.
- (f) The complaint will be handled by another Department of City government and police action is not required.

324.2.2 HANDWRITTEN FORMS AND DOCUMENTS

The forms listed below may not be available to be completed electronically and will need to be handwritten. All copies of these will be turned into the Records Unit upon being completed.

- Juvenile Citation
- Misdemeanor/Traffic Citation
- Driver Exchange Forms

Salt Lake City Police Department

SLCPD Policy Manual

SLCPD Policy Manual

Report Preparation

- State DUI Report Form
- Witness Statements
- Mail-In Property Form
- Emergency Application for Involuntary Commitment Without Certification Form (Pink Sheet)
- Jail Release Agreement
- Pursuit Incident Report Form

324.2.3 INJURY OR DAMAGE BY CITY PERSONNEL

Reports shall be taken if an injury occurs that is a result of an act of a City employee. Additionally, reports shall be taken involving damage to City property or City equipment (see the Traffic Collision Policy for officer-involved traffic accident reporting requirements).

If the injury or damage is significant, or may expose the City to potential liability, a supervisor will be notified. Supervisors notified of such events should consider requesting an investigation by an allied agency, notification of the Chief of Police via chain of command, and involvement of City Risk Management assistance.

No employee shall imply or state the City or Department will pay or make reimbursement to any individual or group for any damages or expenses incurred by that individual or group as a result of police action. Any individual or group making a claim for damages or expenses incurred by that individual or group as a result of police action is to be referred to the City Attorney's Office at (801) 535-7788.

324.2.4 ALTERNATE REPORTING FOR VICTIMS

Reports that may be submitted by the public via online reporting include:

- (a) Lost property.
- (b) Misdemeanor thefts of property, other than firearms or materials that threaten public safety, when there is no suspect information.
 1. Misdemeanor thefts of cellular telephones may be reported even though they have a serial number.
- (c) Misdemeanor vandalism with no suspect information and no hate crime implications.
- (d) Vehicle burglaries with no suspect information or evidence.
- (e) Stolen vehicle attempts with no suspect information or evidence.
- (f) Annoying telephone calls with no suspect information.
- (g) Identity theft without an identifiable suspect.
- (h) Online or email fraud solicitations without an identifiable suspect and if the financial loss classifies the crime as a misdemeanor.
- (i) Hit-and-run vehicle collisions with no suspect or suspect vehicle.

Salt Lake City Police Department

SLCPD Policy Manual

SLCPD Policy Manual

Report Preparation

- (j) Supplemental property lists.
- (k) Traffic accidents with no injuries.

Members at the scene of one of the above incidents should not refer the reporting party to an alternate means of reporting without authorization from a supervisor. Members may refer victims to online victim assistance programs (e.g., Federal Communications Commission (FCC) website for identity theft, Internet Crime Complaint Center (IC3) website for computer crimes).

324.3 IN-PERSON CITIZEN SCREENING WITH CITY PROSECUTOR'S OFFICE

In instances where officers refer a citizen to the City Prosecutor's Office (CPO) to "self-screen" a case (i.e., no arrest – officer refused, no citation issued, officer was not satisfied a crime occurred, mutual combat etc.), the officer shall complete an initial report on the incident that is sufficient to allow the CPO to screen the case.

The referring officer must write a detailed initial report articulating the address, type of call they responded on, persons involved, alleged conduct being reported, damage to property, injuries, etc. The officer should also note in their report that the referral to the CPO was made.

324.4 REPORT CORRECTIONS

Supervisors shall review reports for content and accuracy. If a correction is necessary, the reviewing supervisor will notify the employee of the reasons for rejection. The original report should be returned to the reporting employee for correction as soon as practical. It shall be the responsibility of the originating officer to ensure that any report returned for correction is processed in a timely manner.

324.5 REPORT CHANGES OR ALTERATIONS

Reports that have been approved by a supervisor and submitted to the Records Unit for filing and distribution shall not be modified or altered except by way of a supplemental report. Reviewed reports that have not yet been submitted to the Records Unit may be corrected or modified by the authoring officer only with the knowledge and authorization of the reviewing supervisor.

324.5.1 RESTRICTED/PRIVATIZED REPORTS

An officer of the rank of sergeant or above may authorize the privatization/restriction, or partial restriction, of a report which contains information that if given to the public would:

- (a) Jeopardize or hamper an investigation.
- (b) Create a danger of depriving a person of a right to a fair and impartial hearing.
- (c) Identify a source or confidential informant.
- (d) Identify investigative techniques or procedures that if disclosed would hamper enforcement.
- (e) Jeopardize the life or safety of an individual.
- (f) Constitutes an unwarranted invasion of personal privacy.

Salt Lake City Police Department

SLCPD Policy Manual

SLCPD Policy Manual

Report Preparation

Proper procedure will be followed when restricting/privatizing a report. [Salt Lake City Police Department Procedure Manual: 306.2 RESTRICTING/PRIVATIZING A REPORT](#)

324.6 REVISIONS

Enacted: March 5, 2018

Media Relations

325.1 PURPOSE AND SCOPE

This policy provides guidelines for the release of official department information to the media. It also addresses coordinating media access to scenes of disasters, criminal investigations, emergencies and other law enforcement activities.

325.2 POLICY

It is the policy of the Salt Lake City Police Department to be respectful, candid, cooperative, and responsibly transparent with the media. The release of any information to the media shall be done factually and professionally. The release of information shall be accomplished without compromising the integrity of any investigation or infringing upon the rights of any individual.

325.3 CHAIN OF COMMAND

The SLCPD Public Relations Unit falls under the Office of the Chief.

The Communications Administrative Director oversees the members of this Unit and reports directly to the Chief of Police.

The SLCPD Public Relations Unit Sergeant reports to the Communications Administrative Director.

The Department's Graphic Design Specialist direct reports to the Communications Administrative Director.

325.4 RESPONSIBILITIES

The SLCPD Public Relations Unit serves as the primary liaison between the Department and media outlets to ensure information about the Department is appropriately disseminated and consistent.

The ultimate authority and responsibility for the release of information to the media shall remain with the Chief of Police or their designee.

Responsibilities of the SLCPD Public Relations Unit include but are not limited to, listed in alphabetical order:

- (a) Arranging and coordinating Department press conferences.
- (b) Assisting media on routine coverage of Department matters, including providing interviews for print, broadcast, radio, and web-based media.
- (c) Coordinating and authorizing the release of Department information.
- (d) Coordinating with the Department's Government Records Access and Management (GRAMA) coordinator to ensure all release of information is compliant with Utah State Code and Department policy.
- (e) Maintaining the Department's social media accounts.

Salt Lake City Police Department

SLCPD Policy Manual

SLCPD Policy Manual

Media Relations

- (f) Researching, preparing, and distributing written talking points, press releases, website content, and video topics.
- (g) Responding to police scenes that are of significant public concern or interest.

325.5 NOTIFICATION

Recognizing that news coverage or social media posts about the Department occur in real-time and could adversely affect the reputation of the Department, any member of the Department may directly contact the Communications Administrative Director or the Sergeant of the Public Relations Unit to inform them about a potential matter of interest.

The SLCPD Public Relations Unit will attempt to be available to respond to any event that creates a substantial interest or response by the media or when SLCPD members require support with media relations.

In the absence of a Public Information Officer (PIO), the on-scene incident commander may manage media access on the scene and release information to the media in accordance with Department Policy.

By phone call, direct notification to the Communications Administrative Director shall be made by the on-duty Watch Commander in the following situations, listed in alphabetical order:

- Activation of SWAT, Public Order Unit (POU), or the Crash Analysis Reconstruction Team (CAR).
- All significant, unplanned events at large-scale venues (such as parks, schools, shopping centers, etc).
- Amber Alert.
- Any explosion, bomb threat, or suspicious item/device/package requiring a Hazardous Devices Unit (HDU) response.
- Any homicide or suspicious death investigation.
- Any incident involving the serious injury or death of a Department member.
- Any traffic or transportation-related incident (airplane, train, or other modes of transit) that results in critical physical injury or death (Delta or Echo).
- Bias/hate Crimes.
- Blue Alert.
- Confirmed Abductions/kidnappings or bona fide attempted abductions/kidnappings.
- Deployment of any department-issued Unmanned Aerial System (UAS) outside of training purposes.
- Incidents causing, or likely to cause, unusual public concern or news media coverage.
- In-Custody Death.
- Mass casualty incident (death or injury).

Salt Lake City Police Department

SLCPD Policy Manual

SLCPD Policy Manual

Media Relations

- Matters requiring a Public Emergency Alert or Reverse 9-1-1 Notification.
- Missing and endangered children.
- Officer-involved critical incident.
- Riot or large instances of civil unrest.
- Significant road closure events (wherein the road closure, unplanned, is estimated to be two or more hours.)
- Silver Alert.
- The arrest or citation of any law enforcement member.
- The arrest or citation of any level of government, celebrity, or high-profile individual.
- The discharge of a firearm within City limits by any law enforcement agency member, except when discharged for training or to humanely deal with an injured animal.

Nothing shall preclude Watch Commanders, or any other member of the Department, from notifying the Communications Administrative Director or the Sergeant of the Public Relations Unit in situations outside the aforementioned criteria when the member feels the SLCPD Public Relations Unit should be notified in the best interest of the Department or community.

325.6 PROVIDING ADVANCE INFORMATION

To protect the safety and rights of department members and other individuals, providing advance information about planned actions by law enforcement personnel, such as the movement of persons in custody or the execution of an arrest or search warrant, or other operations should not be disclosed to the media, nor should media representatives be invited to be present at such actions except with the prior approval of the Chief of Police.

Any exceptions to the above paragraph should only be considered for the furtherance of legitimate law enforcement purposes. Before approving any exception, the Chief of Police will consider, at a minimum, whether the release of information or the presence of the media would unreasonably endanger any individual or prejudice the rights of any person, or is otherwise prohibited by law.

325.7 MEDIA REQUESTS

All media requests for information or interviews with department employees or access to a law enforcement incident should be referred to the department's Public Relations Unit, Communications Administrative Director, or if unavailable, to the first available Watch Commander.

Media can contact the Department's Public Relations Unit using its media hotline, 801-799-NEWS (6397). This hotline is staffed by a PIO Monday through Friday 7:00 a.m. - 5:00 p.m. No department member shall give media or community members the cell phone number of anyone assigned to the Department's Public Relations Unit without prior permission.

After hours, on weekends, and on holidays, the media hotline will be forwarded to SLC911 Dispatch, which will, in turn, forward inquiries to the on-duty Watch Commander.

Salt Lake City Police Department

SLCPD Policy Manual

SLCPD Policy Manual

Media Relations

The Watch Commander is not expected to, and should not, provide information on any case that did not occur on their shift. In this circumstance, the Watch Commander should instruct the media to email the Department's Public Relations Unit (PolicePRUnit@slcgov.com) or call the media line during the abovementioned time and days. If the Watch Commander feels like the request is of significant interest, the Watch Command may notify the Communications Administrative Director directly.

325.8 RELEASING INFORMATION

The Department's Public Relations Unit may routinely release information, photos, or video to the media without receiving a specific request. This may include media releases regarding critical incidents, information of public concern, updates regarding significant incidents, or requests for public assistance in solving crimes or identifying suspects. This information may also be released through the Department's website or other electronic sources.

Unless coordinated and approved by the Public Relations Unit or Chief's Office, any Department member outside the Public Relations Unit releasing information to media shall, in a reasonable time, but no later than the end of the employee's shift, notify by phone, the Communications Administrative Director or Sergeant of the SLCPD Public Relations Unit about the nature of the media request, the information released and the name of the media outlet(s). For Watch Commanders, this can be achieved via a notation in the Watch Command Log while specifically identifying which media outlet(s) information was provided to.

Information that may generally be released includes:

- An adult arrested person's name, age, description, address, employment, and marital status, and similar background information.
- A general assessment of injuries or damage while avoiding vivid descriptions of wounds or injuries.
- The apparent cause of death, if applicable.
- The identity of the arresting and investigating agency and the length of the investigation.
- The circumstances immediately surrounding an arrest, including, but not limited to, the time and place of the arrest, the initial reason for the stop or pursuit, possession and/or use of firearms/weapons, and a description of items seized at the time of the arrest.
- Information about search warrants used and the issuing authority.
- The nature of the offense or charge.
- Description or schedule of judicial processes.
- The victim's identity, if proper notifications have been made and the disclosure is not otherwise prohibited by law.
- Identification of suspects for whom a warrant has been issued provided the warrant is not sealed.

Salt Lake City Police Department

SLCPD Policy Manual

SLCPD Policy Manual

Media Relations

- Criminal background of a fugitive when the public should be alerted to danger.

Keeping the following information in mind, Department members will:

- Contact and then coordinate with the Department's Public Relations Unit and/or the case manager before releasing any information on a case to ensure the information should be released.
- If applicable, make reasonable efforts to inform and coordinate with the authorized spokesperson of any outside involved agency.
- Not comment on any incident involving an outside agency, unless approved by the Chief of Police. Media inquiries in this situation should be directed to the agency handling the incident.

Further, Department members shall not comment on:

- The name of a victim of a sex crime.
- The name of any juvenile victim or suspect unless the victim is deceased and next-of-kin has been notified, or the suspect is wanted in a homicide-related offense.
- The existence of prior criminal records, that are unrelated to the case under investigation.
- The results of any examinations or tests, or the accused person's failure to submit to such tests.
- The identity, testimony, or credibility of witnesses.
- Opinions about the accused person's guilt or innocence, or the merits of the case or evidence.
- The identity of suspects before their arrest, or the results of the investigative procedures, except to assist in the apprehension of suspects or to warn the public of any danger.
- The hospital location of any victims or suspects.

325.9 MEDIA ACCESS TO SECURED CRIME SCENES

Only authorized media representatives shall be provided escorted access to scenes of disasters, criminal investigations, emergencies, and other law enforcement activities if required by law.

A "Media Staging" location may be established on any incident, based upon available resources, to give media representatives a reasonable working view of a secured police crime scene and convenient access to the PIO, or designee, without violating the integrity of the scene or hindering police operations.

When establishing a media staging location, consideration should be given to the safety of officers, crime victims, the crime scene, community members, and media representatives. The location of any media staging shall not interfere with police operations. Media staging locations may be relocated depending on the needs of the Department.

Salt Lake City Police Department

SLCPD Policy Manual

SLCPD Policy Manual

Media Relations

If an incident requires media to be staged at a distance that prevents them from capturing photos or video, the SLCPD Public Relations Unit will work with the on-scene incident commander to release photos/video to the media or to establish a "pool camera" for escort into a secured scene for a brief amount of time to gather information.

It is possible that media representatives may, on their own, conduct operations outside the media staging location. If the presence of media in a particular area outside the media staging location reasonably obstructs or interferes with the safety of any person, including the media representative, or reasonably interferes with an officer carrying out official law enforcement duties; officers should immediately close the area using police crime scene tape. Media representatives do not have the right to enter private property without the property owner's consent.

Department members will not prevent media members or the public from documenting, broadcasting, taking pictures, or recording video if they have a lawful right to be at the location.

Members may restrict all public access to any location, when reasonable, and for a police need, by setting up police crime scene tape.

Department members may ask the media not to live broadcast (from the ground or air) any active tactical incident. If a department member has concerns about this, they should immediately contact the SLCPD Public Relations Unit or its Communications Administrative Director.

325.9.1 CRITICAL OPERATIONS

Department members shall not jeopardize a critical incident or tactical operation to accommodate the media. All comments to the media during a critical incident or tactical operation shall be coordinated through the incident commander, the Communications Administrative Director, or the on-scene Public Information Officer.

In the event of a natural disaster or mass casualty event, the Public Relations Unit will work closely with the communications teams from the mayor's office, Fire Department, and Emergency Management to ensure timely and accurate information is released to the public.

Whenever the presence of media or other aircraft poses a threat to the public or Department member safety or significantly hampers incident operations, the field supervisor should consider requesting a Temporary Flight Restriction (TFR). All requests for a TFR should be routed through the Watch Commander. The TFR request should include specific information regarding the perimeter and altitude necessary for the incident and should be requested through the appropriate control tower.

If the control tower is not known, the Federal Aviation Administration (FAA) should be contacted (14 CFR 91.137).

Before requesting a TFR for media aircraft, including drones, the Communications Administrative Director shall be consulted. In turn, the Communications Administrative Director will request media aircraft or drones leave the airspace voluntarily.

Salt Lake City Police Department

SLCPD Policy Manual

SLCPD Policy Manual

Media Relations

325.9.2 ACCESS TO ARRESTED PERSONS

Media interviews with individuals who are in custody should not be permitted without the approval of the Chief of Police and the express consent of the person in custody.

325.10 CONFIDENTIAL OR RESTRICTED INFORMATION

It shall be the responsibility of all department members to ensure that confidential or restricted information is not inappropriately released to the media (see the Records Maintenance and Release and Personnel Records policies). When in doubt, authorized and available legal counsel should be consulted prior to releasing any information.

325.10.1 MEMBER INFORMATION

The identities of officers involved in shootings or other critical incidents may only be released to the media upon the consent of the involved officer or upon a formal request, such as to comply with a public records request.

Any requests for copies of related reports including the identity of officers involved in shootings or other critical incidents, shall be referred to the PIO.

The GRAMA Coordinator or the authorized designee should review and fulfill requests.

Such requests will be processed in accordance with the provisions of the Records Maintenance and Release Policy and public records laws (e.g., Government Records Access and Management Act).

325.11 CONTACT INFORMATION

SLCPD Media Line: 801-799-6397

SLCPD PR Unit Email:

325.12 REVISIONS

Enacted: March 5, 2018

Revised: July 5, 2022

Subpoenas and Court Appearances

326.1 PURPOSE AND SCOPE

This policy establishes the guidelines for department members who must appear in court. It will allow the Salt Lake City Police Department to cover any related work absences and keep the Department informed about relevant legal matters.

326.2 POLICY

Salt Lake City Police Department members will respond appropriately to all subpoenas and any other court-ordered appearances.

326.3 SUBPOENAS

Only department members authorized to receive a subpoena on behalf of this department or any of its members may do so.

Subpoenas for court appearances from the City Prosecutor and District Attorney offices will be sent electronically to the Department Subpoena Coordinator. The Department Subpoena Coordinator will log and distribute subpoenas to employees' Outlook account and any other email account as requested. The Subpoena Coordinator will attempt to notify off-duty officers at their residence if they will not be at work prior to the appearance date listed. The Subpoena Coordinator will alert employees of short notice appearances by indicating it in the title of the email. Any employee receiving a subpoena must print it and take it to court at the time of their appearance.

If there is a scheduling conflict with the date listed on the subpoena, it is the responsibility of the subpoenaed employee to contact the prosecuting attorney as soon as practicable and advise them of the conflict.

326.3.1 ATTORNEY GENERAL AND CRIMINAL DEFENSE ATTORNEY SUBPOENAS

Attorney General and criminal defense attorney subpoenas for criminal cases where Department employees are witnesses may come in the mail or be hand delivered to the Department Subpoena Coordinator. The Subpoena Coordinator will notify officers in the same manner as with City Prosecutor and District Attorney subpoenas.

326.3.2 CIVIL SUBPOENA FOR ACTIONS TAKEN IN AN OFFICIAL CAPACITY

The City Recorder's Office will accept subpoenas for employees in civil matters if the employee is being named in his or her official capacity. The subpoena will be forwarded to the City Attorney's Office and assigned to the Police Legal Advisor. The Police Legal Advisor will contact the subpoenaed employee regarding the civil subpoena. Any questions regarding the civil subpoena should be directed to the Police Legal Advisor.

326.3.3 CIVIL SERVICE COMMISSION SUBPOENAS

For subpoenas issued by the Civil Service Commission (CSC), service may be directed via email to the employee's Outlook email account from the party requesting the subpoena. If a CSC subpoena

Salt Lake City Police Department

SLCPD Policy Manual

SLCPD Policy Manual

Subpoenas and Court Appearances

is received, employees shall notify their immediate supervisor and the Police Legal Advisor as soon as practicable.

326.4 FAILURE TO APPEAR

Any member who fails to comply with the terms of any properly served subpoena or court-ordered appearance may be subject to discipline. This includes properly served orders to appear that were issued by a state administrative agency.

326.5 COURTHOUSE PROTOCOL

When appearing in court, members shall:

- (a) Be punctual and prepared to proceed immediately with the case for which they are scheduled to appear.
- (b) Dress in a department uniform or business attire.
- (c) Observe all rules of the court in which they are appearing and remain alert to changes in the assigned courtroom where their matter is to be heard.

326.6 OVERTIME

When a member appears in court on his/her off-duty time, he/she will be compensated in accordance with the applicable memorandum of understanding, City policy, or compensation plan.

326.6.1 OFF-DUTY RELATED SUBPOENAS

Members receiving valid subpoenas for off-duty actions not related to their employment or appointment will not be compensated for their appearance. Arrangements for time off shall be coordinated through their immediate supervisors.

326.7 OTHER PROCESS SERVICES

All personnel, except the Chief of Police, must be served legal documents (that are not subpoenas) in person. The Chief of Police may only be served via the Chief's executive assistant. If a process server approaches the front desk or any other employee in order to serve legal documents on any employee:

- (a) Do not provide personal information about employee(s) being served.
- (b) Do not accept any documents on behalf of employee(s) being served.
- (c) Do advise the server if the employee is on-duty, and/or provide scheduled days and shift of the employee.
 - i. Have dispatch call the employee to the police department for the service to be made if the employee is working and not busy.
- (d) If the employee is unavailable and the process server refuses to accept that explanation, refer them to the City Attorney's Office.

326.8 REVISIONS

Enacted: March 5, 2018

Outside Agency Assistance

327.1 PURPOSE AND SCOPE

The purpose of this policy is to provide guidance to members when requesting or responding to a request for mutual aid or when assisting another law enforcement agency.

327.2 POLICY

It is the policy of the Salt Lake City Police Department to promptly respond to requests for assistance by other law enforcement agencies, subject to available resources and consistent with the applicable laws and policies of this department.

327.3 ASSISTING OUTSIDE AGENCIES

Generally, requests for any type of assistance from another agency should be routed to the Watch Commander for approval. In some instances, a mutual aid agreement or other established protocol may exist that eliminates the need for approval of individual requests.

When another law enforcement agency requests assistance from this department, the Watch Commander may authorize, if available, an appropriate number of personnel to assist. Members are reminded that their actions when rendering assistance must conform with applicable laws and be consistent with the policies of this department.

Officers may respond to a request for emergency assistance, however, they shall notify a supervisor of their activity as soon as practicable.

327.4 REQUESTING OUTSIDE ASSISTANCE

If assistance is needed from another agency, the member requesting assistance should, if practicable, first notify a supervisor. The handling member or supervisor should direct assisting personnel to where they are needed and to whom they should report when they arrive.

The requesting member should arrange for appropriate radio communication capabilities, if necessary and available, so that communication can be coordinated between assisting personnel.

327.5 RESPONDING TO INCIDENTS OCCURRING ON JURISDICTIONAL BOUNDARIES

Officers shall respond to any incident occurring on or near City boundaries when jurisdiction is questionable. The investigation may be turned over to another agency once the actual jurisdiction is determined.

327.6 REVISIONS

Enacted: March 5, 2018

Registered Offender Information

328.1 PURPOSE AND SCOPE

This policy establishes guidelines by which the Salt Lake City Police Department will address issues associated with certain offenders who are residing in the jurisdiction and how the Department will disseminate information and respond to public inquiries for information about registered sex, kidnap, and child abuse offenders.

328.2 POLICY

It is the policy of the Salt Lake City Police Department to identify and monitor registered offenders living within this jurisdiction and to take reasonable steps to address the risks those persons may pose.

328.3 REGISTRATION

The Investigations Division Commander shall establish a process to reasonably accommodate registration of certain offenders. The process should rebut any allegation on the part of the offender that the registration process was too confusing, burdensome or difficult for compliance. If it is reasonable to do so, an investigator assigned to related investigations should conduct the registration in order to best evaluate any threat the person may pose to the community. Employees assigned to register offenders should receive appropriate training regarding the registration process (Utah Code 77-41-104; Utah Code 77-43-104).

Upon conclusion of the registration process, the investigator shall ensure that the registration information is provided to the Utah Department of Corrections (DOC).

The refusal of a registrant to provide any of the required information or complete the process should initiate a criminal investigation for failure to register (Utah Code 77-41-107; Utah Code 77-43-106).

328.3.1 CONTENTS OF REGISTRATION

Any person residing in the jurisdiction of the Salt Lake City Police Department who is required to register as a sex, kidnap, and/or child abuse offender and is no longer under the supervision of the Division of Adult Probation and Parole must provide the following (Utah Code 53-10-404; Utah Code 77-41-105; Utah Code 77-43-105):

- (a) All names and aliases
- (b) The primary and secondary residence addresses
- (c) A physical description, date of birth, height, weight, eye and hair color
- (d) The make, model, color, year, plate number and vehicle identification number of any vehicle or vehicles owned or regularly driven
- (e) A current photograph
- (f) A set of fingerprints, if one has not already been provided

Salt Lake City Police Department

SLCPD Policy Manual

SLCPD Policy Manual

Registered Offender Information

- (g) A DNA specimen, taken in accordance with Utah Code 53-10-404, if one has not already been provided
- (h) Telephone numbers and any other designations used for routing or self-identification in telephonic communications from fixed locations or cellular telephones
- (i) Internet identifiers and any addresses used for routing or self-identification in Internet communications or postings
- (j) The name and Internet address of all websites on which the person is registered using an online identifier, including all online identifiers used to access those websites
- (k) A copy of any passport
- (l) If the person is an alien, all documents establishing immigration status
- (m) All professional licenses that authorize engaging in an occupation or carrying out a trade or business, including any identifiers, such as numbers
- (n) Each educational institution in Utah at which the person is employed, carries on a vocation or is a student, and any change of enrollment or employment status at any educational institution
- (o) The name, telephone number and address of any place of employment
- (p) The name, telephone number and address of any place where the person volunteers
- (q) The person's Social Security number

328.4 DISSEMINATION OF PUBLIC INFORMATION

Employees will not unilaterally make a public notification advising the community of a particular registrant's presence in the community. Employees who identify a significant risk or other public safety issue associated with a registrant should promptly advise their supervisor. The supervisor should evaluate the request and forward the information to the Chief of Police or their designee if warranted. A determination will be made by the Chief of Police or designee, with the assistance of legal counsel as necessary, whether such a public alert should be made.

Members of the public requesting information on registrants should be directed to DOC's SONAR website or the Child Abuse Offender Notification and Registration website for specific registrant information and photographs (Utah Code 77-41-110; Utah Code 77-43-108).

The Records Director shall release local registered offender information to residents in accordance with Utah Code 77-41-108 and Utah Code 77-43-107 and in compliance with a Government Records Access and Management Act (GRAMA) request.

328.4.1 RELEASE NOTIFICATIONS

Registrant information that is released should include notification that:

- (a) The offender registry includes only those persons who have been required by law to register and who are in compliance with the offender registration laws.
- (b) The information is provided as a public service and may not be current or accurate.

Salt Lake City Police Department

SLCPD Policy Manual

SLCPD Policy Manual

Registered Offender Information

- (c) Persons should not rely solely on the offender registry as a safeguard against offenses in their communities.
- (d) The crime for which a person is convicted may not accurately reflect the level of risk.
- (e) Anyone who uses information contained in the registry to harass registrants or commit any crime may be subject to criminal prosecution.

328.5 LEGAL MANDATES AND RELEVANT LAWS

Employees responsible for registering and entering sex or kidnap offenders or child abuse offenders into the database must be certified by the Utah DOC. To obtain and retain certification, the employee must receive initial and annual training from DOC (Utah Code 77-41-104; Utah Code 77-43-104).

The Investigations Division Commander or designee will be responsible for ensuring the appropriate training and certifications are maintained.

328.6 REVISIONS

Enacted: March 5, 2018

Major Incident Notification

329.1 PURPOSE AND SCOPE

The purpose of this policy is to provide guidance to members of this department in determining when, how and to whom notification of major incidents should be made.

329.2 POLICY

The Salt Lake City Police Department recognizes that certain incidents should be brought to the attention of supervisors or other specified personnel of this department to facilitate the coordination of activities and ensure that inquiries from the media and the public may be properly addressed.

329.3 MINIMUM CRITERIA FOR NOTIFICATION

Most situations where the media show a strong interest are also of interest to the Chief of Police and the affected Division Commander. The following list of incident types is provided as a guide for notification and is not intended to be all-inclusive:

- Homicides
- Traffic accidents with fatalities
- Officer-involved shooting on- or off-duty (See the Officer-Involved Shootings and Deaths Policy for special notifications)
- Significant injury or death to employee on- or off-duty
- Death of a prominent Salt Lake City official
- Arrest of Department employee or prominent Salt Lake City official
- Aircraft crash with major damage and/or injury or death
- In-custody deaths
- Incidents where there may be a question as to the agency's liability
- Incidents which may result in heightened community interest

329.4 WATCH COMMANDER RESPONSIBILITY

The Watch Commander is responsible for making the appropriate notifications. The Watch Commander shall make reasonable attempts to obtain as much information on the incident as possible before notification. The Watch Commander shall attempt to make the notifications as soon as practical. Notification should be made by text first; if notification by text is unsuccessful or the situation dictates, notification should be made via phone conversation.

329.4.1 STAFF NOTIFICATION

In the event an incident occurs described in MINIMUM CRITERIA FOR NOTIFICATION, the Chief of Police and Chief of Staff shall be notified, along with the affected Bureau Commander and Division Commander.

Salt Lake City Police Department

SLCPD Policy Manual

SLCPD Policy Manual

Major Incident Notification

329.4.2 DETECTIVE NOTIFICATION

If the incident requires that a detective respond from home, the Lieutenant of the appropriate detail shall be contacted who will then contact the appropriate detective Sergeant.

329.4.3 PUBLIC INFORMATION OFFICER (PIO)

The Public Information Officer shall be called after members of Staff have been notified that it appears the media may have a significant interest in the incident.

329.5 REVISIONS

Enacted: March 5, 2018

Death Investigation

330.1 PURPOSE AND SCOPE

The investigations of cases involving death include those ranging from natural cause to homicide. Some causes of death may not be readily apparent and some cases differ substantially from what they appeared to be initially. The importance of a thorough death investigation cannot be emphasized enough and shall be in accordance with the Utah Medical Examiner Act (Utah Code 26-4-1, et seq.).

330.2 INVESTIGATION CONSIDERATIONS

Death investigation cases require certain actions be taken. Medical personnel shall be called in all suspected death cases unless the death is obvious (decapitated, decomposed). Officers are not authorized to pronounce death. A supervisor shall be notified in all death investigations.

330.2.1 MEDICAL EXAMINER REQUEST

The Medical Examiner's Office is required to inquire into and determine the circumstances, manner, and cause of certain deaths. The Medical Examiner shall be called in any of the following cases (Utah Code 26-4-7; Utah Code 26-2-14; Utah Code 80-2-604):

- (a) Unattended deaths wherein the deceased have not been attended by a physician in a professional capacity in the 365 days prior to death.
- (b) By violence, gunshot, suicide, or accident.
- (c) Sudden death while in apparent good health.
- (d) Unattended deaths, except that an autopsy may only be performed in accordance with the provisions of Utah Code 26-4-9(3).
- (e) Is under suspicious or unusual circumstances.
- (f) Results from poisoning or overdose of drugs.
- (g) Results from diseases that may constitute a threat to public health.
- (h) Results from disease, injury, toxic effect, or unusual exertion incurred within the scope of the decedent's employment.
- (i) Is due to sudden infant death syndrome.
- (j) When a fetal death occurs without medical attendance at or immediately after the delivery or when inquiry is required by the Utah Medical Examiner Act.
- (k) When there is a reason to believe that a child has died as a result of child abuse or neglect.
- (l) Results while the decedent was in prison, jail, police custody, the state hospital, or in a detention or medical facility operated for the treatment of the mentally ill, emotionally disturbed, or delinquent persons.
- (m) Is associated with diagnostic or therapeutic procedures.

Salt Lake City Police Department

SLCPD Policy Manual

SLCPD Policy Manual

Death Investigation

- (n) Is described in Utah Code 26-4-7 when a request is made to assume custody by a District Attorney or law enforcement agency in connection with a potential homicide investigation or prosecution.
- (o) Fire-related deaths.
- (p) Fatal traffic accidents (the Medical Examiner will be involved if requested).

The Medical Examiner will be notified by this Department without delay unless detectives are called out, at which time the follow-up detective will determine when the Medical Examiner's Office will be contacted. Any criminal aspects of any death shall be the responsibility of this department to investigate.

The body shall not be moved or covered without permission from the Medical Examiner or responding investigative personnel, except in circumstances where it is not practicable to leave the body where found, or in such cases where the cause of death is clearly due to natural causes.

However, in all cases, the scene of the event shall not be disturbed until authorization is given by the senior ranking peace officer on the scene and has jurisdiction over the case and conducting the investigation.

330.2.2 SEARCHING DEAD BODIES

The Medical Examiner is generally the only person permitted to search a body known to be dead from any of the circumstances set forth in Utah Code 26-4-7. However, the investigating agency may start to process the body (for example, processing the hands for fingerprints for identification purposes) or take custody of those articles which will assist with proceeding with the investigation without delay. Moreover, an officer is permitted to make a reasonable search of the body of a person for the limited purpose of locating an identification and/or anatomical gift (organ donor) card. If such a donor card is located, the Medical Examiner shall be promptly notified. The officer shall also, as soon as reasonably possible, notify the appropriate organ procurement organization, tissue bank, or eye bank of the identity of the deceased, the next-of-kin (if known) and the funeral establishment taking custody of the deceased (Utah Code 26-28-112).

Should exigent circumstances indicate to an officer that any search of a known dead body is warranted prior to the arrival of the Medical Examiner the investigating officer shall first obtain verbal consent from the Medical Examiner or responding investigative personnel.

Whenever possible, a witness, preferably a relative to the deceased or a member of the household, should be requested to remain at the scene with the officer pending the arrival of the Medical Examiner. The name and address of this person shall be included in the narrative of the death report.

330.2.3 DEATH NOTIFICATION

When practicable, notification to the next-of-kin of the deceased person shall be made, in person, by the officer assigned to the incident. If the next-of-kin lives in another jurisdiction, a law enforcement official from that jurisdiction shall be requested to make the personal notification. If

Salt Lake City Police Department

SLCPD Policy Manual

SLCPD Policy Manual

Death Investigation

next-of-kin is unable to be located or notified, the follow-up detective supervisor shall be notified. The Medical Examiner needs to know if notification has been made.

When making death notifications, officers shall follow proper procedure. [Salt Lake City Police Department Procedure Manual: 307.2 DEATH NOTIFICATION PROCEDURE](#)

330.2.4 UNIDENTIFIED DEAD BODIES

If the identity of a dead body cannot be established, the Medical Examiner will assign a unique identifying number to the body and maintain a file under the assigned number. If possible, this number when applicable shall be included in any report. The follow-up detective supervisor will be notified of any unidentified dead bodies at the time of the incident.

330.2.5 DEATH INVESTIGATION REPORTING

All incidents involving a death shall be documented in an initial report, utilizing the proper NCIC code.

330.2.6 SUSPECTED HOMICIDE

If the initially assigned officer suspects that the death involves a homicide or other suspicious circumstances, the Investigations Division shall be notified to determine the possible need for a detective to respond to the scene for further immediate investigation.

330.2.7 EMPLOYMENT-RELATED DEATHS OR INJURIES

Any member of this agency who responds to and determines that a death, serious illness or serious injury has occurred as a result of an accident at, or in connection with, the victim's employment, shall ensure that the nearest office of the Utah Division of Occupational Safety and Health (OSHA) is notified by telephone or teletype with all pertinent information. This notification can be accomplished by calling OSHA at 1-800-321-6742.

The follow-up detective supervisor will be notified at the time of the incident.

330.3 INVESTIGATIVE PROCEDURES

This Department will investigate any reported deaths to determine if any criminal responsibility exists for the death. Officers assigned to investigate such situations must approach with caution so as not to destroy evidence. Each case must be considered a homicide until proven otherwise.

330.3.1 ATTENDED AND UNATTENDED DEATHS

If the reported death does not appear to be the result of foul play, the officer will follow proper procedure to determine if the death was "attended" or "unattended."

[Salt Lake City Police Department Procedure Manual: 307.3 ATTENDED AND UNATTENDED DEATHS](#)

330.3.2 EVIDENCE RELATED TO DEATH INVESTIGATIONS

Officers shall follow proper procedure for evidence related to death investigations.

Salt Lake City Police Department

SLCPD Policy Manual

SLCPD Policy Manual

Death Investigation

[Salt Lake City Police Department Procedure Manual: 307.4 DEATH INVESTIGATIONS EVIDENCE PROCEDURES](#)

330.3.3 SUICIDE/SUSPICIOUS DEATH INVESTIGATION PROCEDURES

Officers shall follow proper procedure when investigating suicides and suspicious deaths.

[Salt Lake City Police Department Procedure Manual: 307.5 SUICIDE/SUSPICIOUS DEATH INVESTIGATION PROCEDURES](#)

330.4 REVISIONS

Enacted: March 5, 2018

Identity Fraud

331.1 PURPOSE AND SCOPE

Identity fraud is a growing trend that frequently involves related crimes in multiple jurisdictions. This policy is intended to provide guidelines for the reporting and investigation of such crimes under the Identity Fraud Act (Utah Code 76-6-1101).

331.2 REPORTING

- (a) In an effort to maintain uniformity in reporting, officers presented with the crime of identity fraud (Utah Code 76-6-1102) shall initiate a report for victims residing within the jurisdiction of the Department. For incidents of identity fraud occurring outside this jurisdiction, officers should observe the following:
 - i. For any victim not residing within this jurisdiction, the victim should be encouraged to promptly report the identity theft to the law enforcement agency where he/she resides.
- (b) Identity fraud reports will only be taken online through the SLCPD online report website or in person. Telephonic reports for identity fraud will not be accepted.
- (c) While the crime of identity theft should be reported to the law enforcement agency where the victim resides, officers of the Department should investigate and report crimes occurring within this jurisdiction which have resulted from the original identity theft (e.g., the identity theft occurred elsewhere, but the credit card fraud occurred and was reported in this jurisdiction).
- (d) Officers should include all known incidents of fraudulent activity (e.g., credit card number applied for in victim's name when the victim has never made such an application).
- (e) Officers are encouraged to refer the victim to the Federal Trade Commission's website for Identity Theft. This website will provide the victim with multiple resources to recover their identity and take steps to ensure their information is no longer at risk.
 - i. <https://www.identitytheft.gov/>
- (f) Victims should also be encouraged to contact one of the three major credit reporting companies: Equifax, Experian, and Trans Union. Victims may place a fraud alert or a freeze on their credit through these companies.

Equifax	www.equifax.com	1-800-525-6285
Experian	www.experian.com	1-888-397-3742
Trans Union	www.transunion.com	1-800-680-7289

331.3 REVISIONS

Enacted: March 5, 2018

Private Persons Arrests

332.1 PURPOSE AND SCOPE

The purpose of this policy is to provide guidance for the handling of private persons' arrests made pursuant to Utah Code 77-7-3.

332.2 ARRESTS BY PRIVATE PERSONS

Utah Code 77-7-3 provides that a private person may arrest another:

- (a) For a public offense committed or attempted in his/her presence.
- (b) When a felony has been in fact committed, and he/she has reasonable cause for believing the person arrested has committed it.

Unlike peace officers, private persons may not make an arrest on suspicion that a felony has been committed. The felony must in fact have taken place.

332.2.1 MANNER OF MAKING PRIVATE ARREST

The person making the arrest shall inform the person being arrested of his intention, cause and authority to arrest him. Such notice shall not be required when (Utah Code 77-7-6):

- (a) There is reason to believe the notice will endanger the life or safety of the person or another or will likely enable the party being arrested to escape.
- (b) The person being arrested is actually engaged in the commission of, or an attempt to commit, an offense.
- (c) The person being arrested is pursued immediately after the commission of an offense or an escape.

332.2.2 FORCE TO MAKE A PRIVATE PERSONS ARREST

Any person is justified in using any force, except deadly force, that he/she reasonably believes to be necessary to effect an arrest or to defend himself/herself or another from bodily harm while making an arrest (Utah Code 76-2-403).

332.3 OFFICER RESPONSIBILITIES

Any officer presented with a private person wishing to make an arrest must determine whether there is reasonable cause to believe that such an arrest would be lawful.

- (a) Should any officer determine that there is no reasonable cause to believe that a private person's arrest is lawful, the officer should take no action to further detain or restrain the individual beyond that which reasonably appears necessary to investigate the matter, determine the lawfulness of the arrest and protect the public safety.
 - 1. Any officer who determines that a private person's arrest appears to be unlawful should promptly release the arrested individual. The officer must include the basis of such a determination in a related report.

Salt Lake City Police Department

SLCPD Policy Manual

SLCPD Policy Manual

Private Persons Arrests

2. Absent reasonable cause to support a private person's arrest or other lawful grounds to support an independent arrest by the officer, the officer should advise the parties that no arrest will be made and that the circumstances will be documented in a related report.
- (b) Whenever an officer determines that there is reasonable cause to believe that a private person's arrest is lawful, the officer may exercise any of the following options:
1. Take the individual into physical custody for booking.
 2. Release the individual pursuant to a Citation. The private person's name who made the arrest must appear on the citation (Utah Code 77-7-20(2)(f)).
 3. Release the individual, write a detailed report, and explain the screening process of the applicable Prosecuting Attorney's Office to the arresting individual.

When deciding the best course of action, officers will keep the proper procedures in mind. [Salt Lake City Police Department Procedure Manual: 308.2 DETERMINING IF A PRIVATE PERSONS ARREST IS LAWFUL](#)

332.4 REVISED

Enacted: March 5, 2018

Limited English Proficiency Services

333.1 PURPOSE AND SCOPE

This policy provides guidance to members when communicating with individuals with limited English proficiency (LEP) (42 USC § 2000d).

333.1.1 DEFINITIONS

Definitions related to this policy include:

Authorized interpreter - A person who has been screened and authorized by the Department to act as an interpreter and/or translator for others.

Interpret or interpretation - The act of listening to a communication in one language (source language) and orally converting it to another language (target language), while retaining the same meaning.

Limited English proficient (LEP) - Any individual whose primary language is not English and who has a limited ability to read, write, speak or understand English. These individuals may be competent in certain types of communication (e.g., speaking or understanding) but still be LEP for other purposes (e.g., reading or writing). Similarly, LEP designations are context-specific; an individual may possess sufficient English language skills to function in one setting but these skills may be insufficient in other situations.

Bilingual member - A member of the Salt Lake City Police Department who has the ability to communicate fluently, directly and accurately in both English and another language. Bilingual members may be fluent enough to communicate in a non-English language but may not be sufficiently fluent to interpret or translate from one language into another.

Translate or translation - The replacement of written text from one language (source language) into an equivalent written text (target language).

333.2 POLICY

It is the policy of the Salt Lake City Police Department to reasonably ensure that LEP individuals have meaningful access to law enforcement services, programs and activities, while not imposing undue burdens on its members.

The Department will not discriminate against or deny any individual access to services, rights or programs based upon national origin or any other protected interest or right.

333.3 LEP COORDINATOR

The Chief of Police shall delegate certain responsibilities to an LEP Coordinator.

The responsibilities of the LEP Coordinator include, but are not limited to:

- (a) Coordinating and implementing all aspects of the Salt Lake City Police Department's LEP services to LEP individuals.

Salt Lake City Police Department

SLCPD Policy Manual

SLCPD Policy Manual

Limited English Proficiency Services

- (b) Developing procedures that will enable members to access LEP services, including telephonic interpreters, and ensuring the procedures are available to all members.
- (c) Ensuring that a list of all bilingual members and authorized interpreters is maintained and available to each Watch Commander and Dispatch Supervisor. The list should include information regarding the following:
 - 1. Languages spoken
 - 2. Contact information
 - 3. Availability
- (d) Ensuring signage stating that interpreters are available free of charge to LEP individuals is posted in appropriate areas and in the most commonly spoken languages.
- (e) Reviewing existing and newly developed documents to determine which are vital documents and should be translated, and into which languages the documents should be translated.
- (f) Annually assessing demographic data and other resources, including contracted language services utilization data and community-based organizations, to determine if there are additional documents or languages that are appropriate for translation.
- (g) Identifying standards and assessments to be used by the Department to qualify individuals as authorized interpreters.
- (h) Periodically reviewing efforts of the Department in providing meaningful access to LEP individuals, and, as appropriate, developing reports, new procedures or recommending modifications to this policy.
- (i) Receiving and responding to complaints regarding department LEP services.
- (j) Ensuring appropriate processes are in place to provide for the prompt and equitable resolution of complaints and inquiries regarding discrimination in access to department services, programs and activities.

333.4 FOUR-FACTOR ANALYSIS

Since there are many different languages that members could encounter, the Department will utilize the four-factor analysis outlined in the U.S. Department of Justice (DOJ) Guidance to Federal Financial Assistance Recipients, available at the DOJ website, to determine which measures will provide meaningful access to its services and programs. It is recognized that law enforcement contacts and circumstances will vary considerably. This analysis, therefore, must remain flexible and will require an ongoing balance of four factors, which are:

- (a) The number or proportion of LEP individuals eligible to be served or likely to be encountered by department members, or who may benefit from programs or services within the jurisdiction of the Department or a particular geographic area.
- (b) The frequency with which LEP individuals are likely to come in contact with department members, programs or services.

Salt Lake City Police Department

SLCPD Policy Manual

SLCPD Policy Manual

Limited English Proficiency Services

- (c) The nature and importance of the contact, program, information or service provided.
- (d) The cost of providing LEP assistance and the resources available.

333.5 TYPES OF LEP ASSISTANCE AVAILABLE

Salt Lake City Police Department members should never refuse service to an LEP individual who is requesting assistance, nor should they require an LEP individual to furnish an interpreter as a condition for receiving assistance. The Department will make every reasonable effort to provide meaningful and timely assistance to LEP individuals through a variety of services.

LEP individuals may choose to accept department-provided LEP services at no cost or they may choose to provide their own.

Department-provided LEP services may include, but are not limited to, the assistance methods described in this policy.

333.6 WRITTEN FORMS AND GUIDELINES

Vital documents or those that are frequently used should be translated into languages most likely to be encountered. The LEP Coordinator will arrange to make these translated documents available to members and other appropriate individuals, as necessary.

333.7 AUDIO RECORDINGS

The Department may develop audio recordings of important or frequently requested information in a language most likely to be understood by those LEP individuals who are representative of the community being served.

333.8 BILINGUAL MEMBERS

Bilingual members may be utilized to provide LEP services. The bilingual member(s) must have sufficient knowledge/ability to adequately communicate between department members and the LEP individual(s).

333.9 AUTHORIZED INTERPRETERS

Any person designated by the Department to act as an authorized interpreter and/or translator must have demonstrated competence in both English and the involved non-English language, must have an understanding of the functions of an interpreter that allows for correct and effective translation, and should not be a person with an interest in the department case or investigation involving the LEP individual. A person providing interpretation or translation services may be required to establish the accuracy and trustworthiness of the interpretation or translation in a court proceeding.

Authorized interpreters must pass a screening process established by the LEP Coordinator which demonstrates that their skills and abilities include:

- (a) The competence and ability to communicate information accurately in both English and in the target language.

Salt Lake City Police Department

SLCPD Policy Manual

SLCPD Policy Manual

Limited English Proficiency Services

- (b) Knowledge, in both languages, of any specialized terms or concepts peculiar to this department and of any particularized vocabulary or phraseology used by the LEP individual.
- (c) The ability to understand and adhere to the interpreter role without deviating into other roles, such as counselor or legal adviser.
- (d) Knowledge of the ethical issues involved when acting as a language conduit.

333.9.1 SOURCES OF AUTHORIZED INTERPRETERS

The Department may contract with authorized interpreters who are available over the telephone. Members may use these services in compliance with established procedures.

Other sources may include:

- Bilingual members of this department or personnel from other City departments.
- Individuals employed exclusively to perform interpretation services.
- Contracted in-person interpreters, such as state or federal court interpreters, among others.
- Interpreters from other agencies who have been qualified as interpreters by this department, and with whom the Department has a resource-sharing or other arrangement that they will interpret according to department guidelines.

333.9.2 INTERPRETER SERVICES AND DOCUMENT TRANSLATION

Department members in need of interpreter services shall follow proper procedure for obtaining such. [Salt Lake City Police Department Procedure Manual: 309.2 OBTAINING INTERPRETER SERVICES](#)

Department members requesting translation of documents shall follow proper procedure in making the request. [Salt Lake City Police Department Procedure Manual: 309.3 DOCUMENT TRANSLATION](#)

333.9.3 COMMUNITY VOLUNTEERS AND OTHER SOURCES OF LANGUAGE ASSISTANCE

Language assistance may be available from community volunteers who have demonstrated competence in either monolingual (direct) communication and/or in interpretation or translation (as noted in above), and have been approved by the Department to communicate with LEP individuals.

Where bilingual members or other authorized interpreters are unavailable to assist, approved community volunteers who have demonstrated competence may be called upon when appropriate. However, department members must carefully consider the nature of the contact and the relationship between the LEP individual and the volunteer to ensure that the volunteer can provide neutral and unbiased assistance.

While family or friends of an LEP individual may offer to assist with communication or interpretation, members should carefully consider the circumstances before relying on such

Salt Lake City Police Department

SLCPD Policy Manual

SLCPD Policy Manual

Limited English Proficiency Services

individuals. For example, children should not be relied upon except in exigent or very informal and non-confrontational situations.

333.10 CONTACT AND REPORTING

While all law enforcement contacts, services and individual rights are important, this department will utilize the four-factor analysis to prioritize service to LEP individuals so that such services may be targeted where they are most needed, according to the nature and importance of the particular law enforcement activity involved.

Whenever any member of this department is required to complete a report or other documentation and interpretation services are provided to any involved LEP individual, such services should be noted in the related report. Members should document the type of interpretation services utilized and whether the individual elected to use services provided by the Department or some other identified source.

333.11 EMERGENCY CALLS TO 9-1-1

Department members will make every reasonable effort to promptly accommodate LEP individuals utilizing 9-1-1 lines. When a 9-1-1 call-taker receives a call and determines that the caller is an LEP individual, the call-taker shall quickly determine whether sufficient information can be obtained to initiate an appropriate emergency response. If language assistance is still needed, the language is known and a bilingual member is available in Dispatch, the call shall immediately be handled by the bilingual member.

If a bilingual member is not available or the call-taker is unable to identify the caller's language, the call-taker will contact the contracted telephone interpretation service and establish a three-way call between the call-taker, the LEP individual and the interpreter.

Dispatchers will make reasonable effort to dispatch a bilingual member to the assignment, if available and appropriate.

While 9-1-1 calls shall receive top priority, reasonable efforts should also be made to accommodate LEP individuals seeking routine access to services and information by utilizing the resources listed in this policy.

333.12 FIELD ENFORCEMENT

Field enforcement will generally include such contacts as traffic stops, pedestrian stops, serving warrants and restraining orders, crowd/traffic control and other routine field contacts that may involve LEP individuals. The scope and nature of these activities and contacts will inevitably vary. Members and/or supervisors must assess each situation to determine the need and availability of language assistance to all involved LEP individuals and utilize the methods outlined in this policy to provide such assistance.

Although not every situation can be addressed in this policy, it is important that members are able to effectively communicate the reason for a contact, the need for information and the meaning

Salt Lake City Police Department

SLCPD Policy Manual

SLCPD Policy Manual

Limited English Proficiency Services

or consequences of any enforcement action. For example, it would be meaningless to request consent to search if the officer is unable to effectively communicate with an LEP individual.

If available, and practicable, officers should obtain the assistance of a bilingual member or an authorized interpreter before placing an LEP individual under arrest.

333.13 INVESTIGATIVE FIELD INTERVIEWS

In any situation where an interview may reveal information that could be used as the basis for arrest or prosecution of an LEP individual and a bilingual member is unavailable or lacks the skills to directly communicate with the LEP individual, an authorized interpreter should be used. This includes interviews conducted during an investigation with victims, witnesses and suspects. In such situations, audio recordings of the interviews should be made when reasonably possible. Identification and contact information for the interpreter (e.g., name, address) should be documented so that the person can be subpoenaed for trial if necessary.

If an authorized interpreter is needed, officers should consider calling for an authorized interpreter in the following order:

- An authorized department member or allied agency interpreter
- An authorized telephone interpreter
- Any other authorized interpreter

Miranda warnings given to LEP individuals should be provided to suspects in their primary language by a bilingual member, an authorized interpreter, or, if the suspect is literate, by providing a translated *Miranda* warning card.

The use of an LEP individual's bilingual friends, family members, children, neighbors or bystanders may be used only when a bilingual member or authorized interpreter is unavailable and there is an immediate need to interview an LEP individual.

333.14 CUSTODIAL INTERROGATIONS

Miscommunication during custodial interrogations may have a substantial impact on the evidence presented in a criminal prosecution. Only bilingual members or, if none are available or appropriate, authorized interpreters shall be used during custodial interrogations. *Miranda* warnings given to LEP individuals should be provided to suspects in their primary language by a bilingual member, an authorized interpreter, or, if the suspect is literate, by providing a translated *Miranda* warning card.

In order to ensure that translations during custodial interrogations are accurately documented and are admissible as evidence, interrogations should be recorded whenever reasonably possible. See guidance on recording custodial interrogations in the Interrogation and Confessions Policy.

333.15 BOOKINGS

When gathering information during the booking process, members should remain alert to the impediments that language barriers can create. In the interest of the arrestee's health and welfare,

Salt Lake City Police Department

SLCPD Policy Manual

SLCPD Policy Manual

Limited English Proficiency Services

the safety and security of the facility, and to protect individual rights, it is important that accurate medical screening and booking information be obtained. Members should seek the assistance of a bilingual member whenever there is concern that accurate information cannot be obtained.

333.16 COMPLAINTS

The Department shall ensure that LEP individuals who wish to file a complaint regarding members of this department are able to do so. The Department may provide an authorized interpreter, a bilingual member, or translated forms, as appropriate.

Investigations into such complaints shall be handled in accordance with the Complaints Against Personnel and Disciplinary Action Policy.

Any notice required to be sent to an LEP individual as a complaining party pursuant to the Complaints Against Personnel and Disciplinary Action Policy should be translated or otherwise communicated in a language-accessible manner.

333.17 COMMUNITY OUTREACH

Community outreach programs and other such services offered by this department are important to the ultimate success of more traditional law enforcement duties. This department will continue to work with community groups, local businesses and neighborhoods to provide equal access to such programs and services.

333.18 TRAINING

To ensure that all members who may have contact with LEP individuals are properly trained, the Department will provide periodic training on this policy and related procedures, including how to access department-authorized telephonic and in-person interpreters and other available resources.

The Training Lieutenant shall be responsible for ensuring new members receive LEP training.

333.19 REVISIONS

Enacted: March 5, 2018

Communications with Persons with Disabilities

334.1 PURPOSE AND SCOPE

This policy provides guidance to members when communicating with individuals with disabilities, including those who are deaf or hard of hearing, have impaired speech or vision, or are blind.

334.1.1 DEFINITIONS

Definitions related to this policy include:

Auxiliary aids - These are used to communicate with people who have a disability or impairment. They include, but are not limited to, the use of gestures or visual aids to supplement oral communication; use of a notepad and pen or pencil to exchange written notes; use of a computer or typewriter; use of an assistive listening system or device to amplify sound; use of a teletypewriter (TTY), videophones (video relay service or VRS); use of taped text; use of qualified readers; or use of a qualified interpreter.

Disability or impairment - A physical or mental impairment that substantially limits a major life activity, including hearing or seeing, regardless of whether the disabled person uses assistive or adaptive devices or auxiliary aids. Individuals who wear ordinary eyeglasses or contact lenses are not considered to have a disability (42 USC § 12102). This includes a person who has a hearing loss that requires the use of a Telecommunications Device for the Deaf (TDD) to communicate effectively on the telephone (UAC R746-343-2).

Qualified interpreter - A person who is able to interpret effectively, accurately and impartially, both receptively and expressively, using any necessary specialized vocabulary. Qualified interpreters include oral interpreters, transliterators, sign language interpreters and intermediary interpreters. Qualified interpreters should have a certification approved by the Utah Division of Services for the Deaf and Hard of Hearing Interpreters Certification Board (Utah Code 35A-13-605; UAC R993-300-301 et seq.).

334.2 POLICY

It is the policy of the Salt Lake City Police Department to reasonably ensure that people with disabilities, including victims, witnesses, suspects and arrestees have equal access to law enforcement services, programs and activities. Members must make efforts to communicate effectively with individuals with disabilities.

The Department will not discriminate against or deny any individual access to services, rights or programs based upon disabilities.

334.3 AMERICANS WITH DISABILITIES (ADA) COORDINATOR

The Chief of Police shall delegate certain responsibilities to an ADA Coordinator (28 CFR 35.107).

The responsibilities of the ADA Coordinator shall include, but not be limited to:

- (a) Working with the City ADA coordinator regarding the Salt Lake City Police Department's efforts to ensure equal access to services, programs and activities.

Salt Lake City Police Department

SLCPD Policy Manual

SLCPD Policy Manual

Communications with Persons with Disabilities

- (b) Developing reports, new procedures, or recommending modifications to this policy.
- (c) Acting as a liaison with local disability advocacy groups or other disability groups regarding access to department services, programs and activities.
- (d) Ensuring that a list of qualified interpreter services is maintained and available to each Watch Commander and Dispatch Supervisor. The list should include information regarding the following:
 - 1. Contact Information
 - 2. Availability
- (e) Developing procedures that will enable members to access auxiliary aids or services, including qualified interpreters, and ensure the procedures are available to all members.
- (f) Ensuring signage is posted in appropriate areas, indicating that auxiliary aids are available free of charge to people with disabilities.
- (g) Ensuring appropriate processes are in place to provide for the prompt and equitable resolution of complaints and inquiries regarding discrimination in access to department services, programs and activities.

334.4 FACTORS TO CONSIDER

Because the nature of any law enforcement contact may vary substantially from one situation to the next, members of this department should consider all information reasonably available to them when determining how to communicate with an individual with a disability. Members should carefully balance all known factors in an effort to reasonably ensure people who are disabled have equal access to services, programs and activities. These factors may include, but are not limited to:

- (a) Members should not always assume that effective communication is being achieved. When there is any doubt, members should ask the individual to communicate back or otherwise demonstrate their understanding.
- (b) The nature of the disability (e.g., deafness or blindness vs. hard of hearing or low vision).
- (c) The nature of the law enforcement contact (e.g., emergency vs. non-emergency, custodial vs. consensual contact).
- (d) The availability of auxiliary aids. The fact that a particular aid is not available does not eliminate the obligation to reasonably ensure access. However, in an emergency, availability may factor into the type of aid used.

334.5 INITIAL AND IMMEDIATE CONSIDERATIONS

Recognizing that various law enforcement encounters may be potentially volatile and/or emotionally charged, members should remain alert to the possibility of communication problems.

Members should exercise special care in the use of all gestures, and verbal and written communication to minimize initial confusion and misunderstanding when dealing with any individual with known or suspected disabilities.

Salt Lake City Police Department

SLCPD Policy Manual

SLCPD Policy Manual

Communications with Persons with Disabilities

In a non-emergency situation, when a member knows or suspects an individual requires assistance to effectively communicate, the member shall identify the individual's choice of auxiliary aid or service.

The individual's preferred communication method must be honored unless another effective method of communication exists under the circumstances (28 CFR 35.160).

Factors to consider when determining whether an alternative method is effective include:

- (a) The methods of communication usually used by the individual.
- (b) The nature, length and complexity of the communication involved.
- (c) The context of the communication.

In emergency situations involving an imminent threat to the safety or welfare of any person, members may use whatever auxiliary aids and services that reasonably appear effective under the circumstances. This may include, for example, exchanging written notes or using the services of a person who knows sign language but is not a qualified interpreter, even if the person who is deaf or hard of hearing would prefer a qualified sign language interpreter or another appropriate auxiliary aid or service. Once the emergency has ended, the continued method of communication should be reconsidered. The member should inquire as to the individual's preference and give primary consideration to that preference.

If an individual who is deaf, hard of hearing or has impaired speech must be handcuffed while in the custody of the Salt Lake City Police Department, consideration should be given, safety permitting, to placing the handcuffs in the front of the body to facilitate communication using sign language or writing.

334.6 TYPES OF ASSISTANCE AVAILABLE

Salt Lake City Police Department members shall never refuse to assist an individual with disabilities who is requesting assistance. The Department will not charge anyone to receive auxiliary aids, nor shall they require anyone to furnish their own auxiliary aid or service as a condition for receiving assistance. The Department will make every reasonable effort to provide equal access and timely assistance to individuals who are disabled through a variety of services.

A person who is disabled may choose to accept department-provided auxiliary aids or services or they may choose to provide their own.

Department-provided auxiliary aids or services may include, but are not limited to, the assistance methods described in this policy.

334.7 AUDIO RECORDINGS AND ENLARGED PRINT

The Department may develop audio recordings to assist people who are blind or have a visual impairment with accessing important information. If such a recording is not available, members may read aloud from the appropriate form, for example a personnel complaint form, or provide forms with enlarged print.

Salt Lake City Police Department

SLCPD Policy Manual

SLCPD Policy Manual

Communications with Persons with Disabilities

334.8 QUALIFIED INTERPRETERS

A qualified interpreter may be needed in lengthy or complex transactions (e.g., interviewing a victim, witness, suspect or arrestee), if the individual to be interviewed normally relies on sign language or speechreading (lip-reading) to understand what others are saying. The qualified interpreter should not be a person with an interest in the case or the investigation. A person providing interpretation services may be required to establish the accuracy and trustworthiness of the interpretation in a court proceeding.

Qualified interpreters should be:

- (a) Available within a reasonable amount of time but in no event longer than one hour if requested.
- (b) Experienced in providing interpretation services related to law enforcement matters.
- (c) Familiar with the use of VRS and/or video remote interpreting services.
- (d) Certified in either American Sign Language (ASL) or Signed English (SE).
- (e) Able to understand and adhere to the interpreter role without deviating into other roles, such as counselor or legal adviser.
- (f) Knowledgeable of the ethical issues involved when providing interpreter services.

Members should use department-approved procedures to request a qualified interpreter at the earliest reasonable opportunity. No individual who is disabled shall be required to provide his/her own interpreter (28 CFR 35.160).

334.8.1 MEMBER INTERPRETERS

Members who can communicate in sign language may be utilized in situations where their service is required. The signing department member must have sufficient knowledge/ability to adequately communicate between department members and the individual(s) with a disability.

334.9 TTY AND RELAY SERVICES

In situations where an individual without a disability would have access to a telephone (e.g., attorney contacts), members must also provide those who are deaf, hard of hearing or have impaired speech the opportunity to place calls using an available TTY (also known as a telecommunications device for deaf people, or TDD). Members shall provide additional time, as needed, for effective communication due to the slower nature of TTY and TDD communications.

The Department will accept all TTY or TDD calls placed by those who are deaf or hard of hearing and received via a telecommunications relay service (28 CFR 35.162).

Note that relay services translate verbatim, so the conversation must be conducted as if speaking directly to the caller.

334.10 COMMUNITY VOLUNTEERS

Interpreter services may be available from community volunteers who have demonstrated competence in communication services, such as ASL or SE, and have been approved by the Department to provide interpreter services.

Salt Lake City Police Department

SLCPD Policy Manual

SLCPD Policy Manual

Communications with Persons with Disabilities

Where qualified interpreters are unavailable to assist, approved community volunteers who have demonstrated competence may be called upon when appropriate. However, department members must carefully consider the nature of the contact and the relationship between the individual with the disability and the volunteer to ensure that the volunteer can provide neutral and unbiased assistance.

334.11 FAMILY AND FRIENDS

While family or friends may offer to assist with interpretation, members should carefully consider the circumstances before relying on such individuals. The nature of the contact and relationship between the individual with the disability and the person offering services must be carefully considered (e.g., victim/suspect).

Children should not be relied upon except in emergency or critical situations when there is no qualified interpreter reasonably available.

Adults may be relied upon when (28 CFR 35.160):

- (a) There is an emergency or critical situation and there is no qualified interpreter reasonably available.
- (b) The person with the disability requests that the adult interpret or facilitate communication and the adult agrees to provide such assistance, and reliance on that adult for such assistance is reasonable under the circumstances.

334.12 REPORTING

Whenever any member of this department is required to complete a report or other documentation, and communication assistance has been provided, such services should be noted in the related report. Members should document the type of communication services utilized and whether the individual elected to use services provided by the Department or some other identified source. If the individual's express preference is not honored, the member must document why another method of communication was used.

All written communications exchanged in a criminal case shall be attached to the report or placed into evidence.

334.13 FIELD ENFORCEMENT

Field enforcement will generally include such contacts as traffic stops, pedestrian stops, serving warrants and restraining orders, crowd/traffic control and other routine field contacts that may involve individuals with disabilities. The scope and nature of these activities and contacts will inevitably vary.

The Department recognizes that it would be virtually impossible to provide immediate access to complete communication services to every member of this department. Members and/or supervisors must assess each situation and consider the length, complexity and importance of the communication, as well as the individual's preferred method of communication, when determining the type of resources to use and whether a qualified interpreter is needed.

Salt Lake City Police Department

SLCPD Policy Manual

SLCPD Policy Manual

Communications with Persons with Disabilities

Although not every situation can be addressed in this policy, it is important that members are able to effectively communicate the reason for a contact, the need for information and the meaning or consequences of any enforcement action. For example, it would be meaningless to verbally request consent to search if the officer is unable to effectively communicate with an individual who is deaf or hard of hearing and requires communications assistance.

If available, and practicable, officers should obtain the assistance of an interpreter before placing an individual with a disability under arrest. Individuals who are arrested and are assisted by service animals should be permitted to make arrangements for the care of such animals prior to transport.

334.13.1 FIELD RESOURCES

Examples of methods that may be sufficient for transactions, such as checking a license or giving directions to a location or for urgent situations such as responding to a violent crime in progress, may, depending on the circumstances, include such simple things as:

- (a) Hand gestures or visual aids with an individual who is deaf, hard of hearing or has impaired speech.
- (b) Exchange of written notes or communications.
- (c) Verbal communication with an individual who can speechread by facing the individual and speaking slowly and clearly.
- (d) Use of computer, word processing, personal communication device or similar device to exchange texts or notes.
- (e) Slowly and clearly speaking or reading simple terms to individuals who have a visual or mental impairment.

Members should be aware that these techniques may not provide effective communication as required by law and this policy depending on the circumstances.

334.14 CUSTODIAL INTERROGATIONS

In an effort to ensure that the rights of individuals who are deaf, hard of hearing or have speech impairment are protected during a custodial interrogation, this department will provide interpreter services before beginning an interrogation, unless exigent circumstances exist or the individual has made a clear indication that he/she understands the process and desires to proceed without an interpreter. The use of a video remote interpreting service should be considered, where appropriate, if a live interpreter is not available. *Miranda* warnings shall be provided to suspects who are deaf or hard of hearing by a qualified interpreter or by providing a written *Miranda* warning card.

In order to ensure that communications during custodial investigations are accurately documented and are admissible as evidence, interrogations should be recorded whenever reasonably possible. See guidance on recording custodial interrogations in the Interrogation and Confessions Policy.

Salt Lake City Police Department

SLCPD Policy Manual

SLCPD Policy Manual

Communications with Persons with Disabilities

334.15 ARRESTS AND BOOKINGS

If an individual with speech or hearing disabilities is arrested, the arresting officer shall use department-approved procedures to provide a qualified interpreter at the place of arrest or booking as soon as reasonably practicable, unless the individual indicates that he/she prefers a different auxiliary aid or service or the officer reasonably determines another effective method of communication exists under the circumstances.

When gathering information during the booking process, members should remain alert to the impediments that often exist when communicating with those who are deaf, hard of hearing, who have impaired speech or vision, are blind, or have other disabilities. In the interest of the arrestee's health and welfare, the safety and security of the facility and to protect individual rights, it is important that accurate medical screening and booking information be obtained. If necessary, members should seek the assistance of a qualified interpreter whenever there is concern that accurate information cannot be obtained.

Individuals who require and possess personally owned communication aids (e.g., hearing aids, cochlear processors) should be permitted to retain them while in custody.

334.16 COMPLAINTS

The Department shall ensure that individuals with disabilities who wish to file a complaint regarding members of this department are able to do so. The Department may provide a qualified interpreter or forms in enlarged print, as appropriate.

Investigations into such complaints shall be handled in accordance with the Complaints Against Personnel and Disciplinary Action Policy. Qualified interpreters used during the investigation of a complaint should not be members of this Department.

334.17 COMMUNITY OUTREACH

Community outreach programs and other such services offered by this department are important to the ultimate success of more traditional law enforcement duties. This department will continue to work with community groups, local businesses and neighborhoods to provide equal access to such programs and services.

334.18 TRAINING

To ensure that all members who may have contact with individuals who are disabled are properly trained, the Department will provide periodic training that should include:

- (a) Awareness and understanding of this policy and related procedures, related forms and available resources.
- (b) Procedures for accessing qualified interpreters and other available resources.

The Training Lieutenant shall be responsible for ensuring new members receive training related to interacting with individuals who have disabilities, including individuals who are deaf, hard of hearing, who have impaired speech or vision, or are blind.

Salt Lake City Police Department

SLCPD Policy Manual

SLCPD Policy Manual

Communications with Persons with Disabilities

334.18.1 CALL-TAKER TRAINING

Emergency call-takers shall be trained in the use of TTY equipment protocols for communicating with individuals who are deaf, hard of hearing or who have speech impairments. Such training and information should include:

- (a) The requirements of the ADA and Section 504 of the Rehabilitation Act for telephone emergency service providers.
- (b) ASL syntax and accepted abbreviations.
- (c) Practical instruction on identifying and processing TTY or TDD calls, including the importance of recognizing silent TTY or TDD calls, using proper syntax, abbreviations and protocol when responding to TTY or TDD calls.
- (d) Hands-on experience in TTY and TDD communications, including identification of TTY or TDD tones.

Training should be mandatory for all Dispatch members who may have contact with individuals from the public who are deaf, hard of hearing or have impaired speech.

334.19 REVISIONS

Enacted: March 5, 2018

School Employee Mandatory Employer Notification

335.1 PURPOSE AND SCOPE

The purpose of this policy is to describe the notification requirements and procedures to follow when a school employee has been arrested for certain offenses.

335.2 POLICY

The Salt Lake City Police Department will meet the reporting mandates of Utah Code 53-10-211 to minimize the risks to children or others.

335.3 MANDATORY NOTIFICATION

If a school employee is arrested, or the Department receives information from another jurisdiction of a school employee's arrest, for any of the following offenses, the on-duty Watch Commander will be notified. The Watch Commander will notify the Investigations Division Person Crimes Lieutenant who shall, as soon as practicable, report the arrest to the State Board of Education and the superintendent of the school district that employs the employee (Utah Code 53-10-211):

- (a) Any controlled substance offense under Utah Code 58-37-8
- (b) Any offense under Utah Code 76-5-401 et seq. (sexual offenses)
- (c) Any offense involving sexual conduct

If the person is an employee of a private school, notification shall be made to the administrator of the school.

335.4 REVISIONS

Enacted: March 5, 2018

Chaplains

336.1 PURPOSE AND SCOPE

This policy establishes the guidelines for Salt Lake City Police Department chaplains to provide counseling or emotional support to members of the Department, their families and members of the public.

336.2 POLICY

The Salt Lake City Police Department shall ensure that department chaplains are properly appointed, trained and supervised to carry out their responsibilities without financial compensation.

336.3 ELIGIBILITY

Requirements for participation as a chaplain for the Department may include, but are not limited to:

- (a) Being a licensed or ordained clergy with standing in a church, endorsed by a major faith in the United States or an officer of said denomination, or a certified professional chaplain.
- (b) Being above reproach, temperate, prudent, respectable, hospitable, able to teach, and be free from addiction to alcohol or other drugs.
- (c) Having a good reputation in the community.
- (d) Successful completion of an appropriate-level background investigation.
- (e) Possession of a valid driver license.

336.4 RECRUITMENT, SELECTION AND APPOINTMENT

The Salt Lake City Police Department shall endeavor to recruit and appoint only those applicants who meet the high ethical, moral and professional standards set forth by this department.

336.4.1 RECRUITMENT

Chaplains should be recruited as needed, consistent with department policy on equal opportunity and nondiscriminatory employment. A primary qualification for participation in the application process should be an interest in and an ability to assist the Department in serving the public.

336.4.2 SELECTION AND APPOINTMENT

Chaplain candidates shall successfully complete the following process prior to appointment as a chaplain:

- (a) Submit the appropriate written application.
- (b) Interview with the chaplain coordinator.
- (c) Successfully complete an appropriate-level background investigation.
- (d) Complete a six-month probationary period.

Salt Lake City Police Department

SLCPD Policy Manual

SLCPD Policy Manual

Chaplains

Chaplain candidates must be approved by the police department chaplain coordinator and other chaplains prior to being accepted as chaplain. Once accepted, the chaplain is commissioned as a volunteer chaplain of this Department. Chaplains will serve for a two-year period. Extensions may be granted by the chaplain coordinator.

Chaplains are volunteers and serve at the discretion of the Chief of Police. Chaplains shall have no property interest in continued appointment. However, if a chaplain is removed for alleged misconduct, the chaplain will be afforded an opportunity solely to clear his/her name through a liberty interest hearing, which shall be limited to a single appearance before the Chief of Police or the authorized designee.

336.5 IDENTIFICATION AND UNIFORMS

As representatives of the Department, chaplains are responsible for presenting a professional image to the community. Chaplains shall dress appropriately for the conditions and performance of their duties. Identification symbols worn by chaplains shall be different and distinct from those worn by officers, and when warranted, apparel shall have the inclusion of the word "Chaplain". Uniforms, symbols, and apparel shall not reflect any religious affiliation.

Chaplains will be issued Salt Lake City Police Department identification cards, which must be carried at all times while on-duty. The identification cards will be the standard Salt Lake City Police Department identification card, with the exception that "Chaplain" will be indicated on the card. Chaplains shall be required to return any issued identification or department property at the termination of service.

336.6 CHAPLAIN COORDINATOR

The Chief of Police shall delegate certain responsibilities to a chaplain coordinator. The coordinator shall be appointed by the Chief of Police and directly responsible to the Support Division Commander or their authorized designee.

The chaplain coordinator shall serve as the liaison between the chaplains and the Chief of Police. The function of the coordinator is to provide a central coordinating point for effective chaplain management within the Department, and to direct and assist efforts to jointly provide more productive chaplain services. Chaplains shall report to the chaplain coordinator or their designee.

The chaplain coordinator shall organize the chaplains in the most efficient manner possible in order to facilitate chaplain services and responsibilities.

The responsibilities of the coordinator or the authorized designee include, but are not limited to:

- (a) Recruiting, selecting and training qualified chaplains.
- (b) Conducting chaplain meetings.
- (c) Establishing and maintaining a chaplain callout roster.
- (d) Maintaining records for each chaplain.
- (e) Tracking and evaluating the contribution of chaplains.

Salt Lake City Police Department

SLCPD Policy Manual

SLCPD Policy Manual

Chaplains

- (f) Maintaining a record of chaplain schedules and work hours.
- (g) Completing and disseminating, as appropriate, all necessary paperwork and information.
- (h) Planning periodic recognition events.
- (i) Maintaining liaison with other agency chaplain coordinators.

336.7 DUTIES AND RESPONSIBILITIES

Chaplains assist the Department, its members and the community, as needed. Assignments of chaplains will usually be to augment the Patrol Divisions. Chaplains may be assigned to other areas within the Department as needed. Chaplains should be placed only in assignments or programs that are consistent with their knowledge, skills, abilities and the needs of the Department.

All chaplains will be assigned to duties by the chaplain coordinator or their authorized designee.

Chaplains may not proselytize or attempt to recruit members of the Department or the public into a religious affiliation while representing themselves as chaplains with this department. If there is any question as to the receiving person's intent, chaplains should verify that the person is desirous of spiritual counseling or guidance before engaging in such discussion.

Chaplains may not accept gratuities for any service or any subsequent actions or follow-up contacts that were provided while functioning as a chaplain for the Salt Lake City Police Department.

336.7.1 COMPLIANCE

Chaplains are volunteer members of this department, and except as otherwise specified within this policy, are required to comply with the Volunteer Program Policy and other applicable policies.

336.7.2 OPERATIONAL GUIDELINES

- (a) Chaplains will be scheduled based on their availability as volunteers. The schedule shall be provided to dispatch via an on-call roster.
- (b) Chaplains shall be permitted to ride with officers during any shift and observe Salt Lake City Police Department operations, provided the Watch Commander has been notified and has approved the activity.
- (c) Chaplains shall not be evaluators of members of the Department.
- (d) In responding to incidents, a chaplain shall never function as an officer.
- (e) When responding to in-progress calls for service, chaplains may be required to stand-by in a secure area until the situation has been deemed safe.
- (f) Chaplains shall respond to locations of service as directed by the supervisors or officers directing their service.

336.7.3 ASSISTING DEPARTMENT MEMBERS

The responsibilities of a chaplain related to department members include, but are not limited to:

Salt Lake City Police Department

SLCPD Policy Manual

SLCPD Policy Manual

Chaplains

- (a) Assisting in making notification to families of members who have been seriously injured or killed and, after notification, responding to the hospital or home of the member.
- (b) Visiting sick or injured members in the hospital or at home.
- (c) Attending and participating, when requested, in funerals of active or retired members and/or their families.
- (d) Serving as a resource for members when dealing with the public in incidents, such as accidental deaths, suicides, suicidal subjects, serious accidents, drug and alcohol abuse and other such situations that may arise.
- (e) Providing counseling and support for members and their families.
- (f) Being alert to the needs of members and their families.

336.7.4 ASSISTING THE DEPARTMENT

The responsibilities of a chaplain related to this department include, but are not limited to:

- (a) Assisting members in the diffusion of a conflict or incident, when requested.
- (b) Responding to natural and accidental deaths, suicides and attempted suicides, family disturbances and any other incident that in the judgment of an officer or supervisor aids in accomplishing the mission of the Department.
- (c) Responding to major disasters, such as natural disasters, bombings and similar critical incidents.
- (d) Being on-call and, if possible, on-duty during major demonstrations or any public function that requires the presence of a large number of department members.
- (e) Attending department events, such as academy graduations, ceremonies and social events. Chaplains may be asked to offer invocations and benedictions at these events.
- (f) Participating in in-service training classes.
- (g) Willingness to train others to enhance the effectiveness of the Department.

336.7.5 ASSISTING THE COMMUNITY

The duties of a chaplain related to the community include, but are not limited to:

- (a) Fostering familiarity with the role of law enforcement in the community.
- (b) Providing an additional link between the community, other chaplain coordinators and the Department.
- (c) Providing liaison with various civic, business and religious organizations.
- (d) Promptly facilitating requests for representatives or leaders of various denominations.
- (e) Assisting the community in any other function as needed or requested.
- (f) Making referrals in cases where specialized attention is needed or in cases that are beyond the chaplain's ability to assist.

Salt Lake City Police Department

SLCPD Policy Manual

SLCPD Policy Manual

Chaplains

336.7.6 CHAPLAIN MEETINGS

All chaplains are required to attend scheduled meetings. Any absences must be satisfactorily explained to the chaplain coordinator.

336.7.7 CALL-OUT PROCEDURE

The determination and the need for, as well as the actual call-out of the chaplain(s), shall be made by the initial officer via phone or through the Dispatch Service Channel. The officer or dispatcher making the call-out shall brief the responding chaplain(s) regarding the nature of the incident and where to respond, either on the phone or at a rally point prior to responding to the scene.

Call-out of the entire chaplain corps as a responding unit shall be directed to the department chaplain coordinator or designee. Any supervisor may determine this need and may contact the chaplain coordinator or designee to facilitate the call-out.

In the event of a line-of-duty injury and/or death to an officer or other department member, active or retired, the department chaplain coordinator will be notified and utilized instead of using the volunteer chaplains.

336.8 PRIVILEGED COMMUNICATIONS

Department chaplains shall be familiar with state evidentiary laws and rules pertaining to the limits of the clergy-penitent, psychotherapist-patient and other potentially applicable privileges and shall inform members when it appears reasonably likely that the member is discussing matters that are not subject to privileged communications. In such cases, the chaplain should consider referring the member to a non-department counseling resource.

No chaplain shall provide counsel to or receive confidential communications from any Salt Lake City Police Department member concerning an incident personally witnessed by the chaplain or concerning an incident involving the chaplain.

336.9 TRAINING

Chaplains must have a minimum of 12 training hours per year. The training may include:

- Stress management
- Death notifications
- Symptoms of post-traumatic stress
- Burnout for members of law enforcement and chaplains
- Legal liability and confidentiality
- Ethics
- Responding to crisis situations
- The law enforcement family
- Substance abuse

Salt Lake City Police Department

SLCPD Policy Manual

SLCPD Policy Manual

Chaplains

- Suicide
- Officer injury or death
- Sensitivity and diversity

336.10 REVISIONS

Enacted: March 5, 2018

Public Safety Video Surveillance System

337.1 PURPOSE AND SCOPE

This policy provides guidance for the placement and monitoring of department public safety video surveillance, as well as the storage and release of the captured images.

This policy only applies to overt, marked public safety video surveillance systems operated by the Department. It does not apply to mobile audio/video systems, covert audio/video systems or any other image-capturing devices used by the Department.

337.2 POLICY

The Salt Lake City Police Department operates a public safety video surveillance system to complement its anti-crime strategy, to effectively allocate and deploy personnel, and to enhance public safety and security in public areas. Cameras may be placed in strategic locations throughout the City to detect and deter crime, to help safeguard against potential threats to the public, to help manage emergency response situations during natural and man-made disasters and to assist City officials in providing services to the community.

Video surveillance in public areas will be conducted in a legal and ethical manner while recognizing and protecting constitutional standards of privacy.

337.3 OPERATIONAL GUIDELINES

Only department-approved video surveillance equipment shall be utilized. No privately owned devices will be used as video surveillance equipment for department purposes. Members authorized to monitor video surveillance equipment should only place devices on public property, or on private property with the consent of the property owner, and only monitor public areas and public activities where no reasonable expectation of privacy exists. A supervisor shall approve all proposed locations for the use of video surveillance technology. Camera placement will be guided by the needs of the department. Unauthorized recording, viewing, reproduction, dissemination or retention is prohibited.

337.3.1 CAMERA MARKINGS

All public areas that are monitored by public safety surveillance equipment shall be marked in a conspicuous manner with appropriate signs to inform the public that the area is under police surveillance.

337.4 VIDEO SUPERVISION

Supervisors should monitor video surveillance access and usage to ensure members are within department policy and applicable laws. Supervisors should ensure such use and access is appropriately documented. A log should be maintained of all locations where video surveillance monitors are located. Public safety video surveillance systems will not intentionally be used to invade the privacy of individuals or observe areas where a reasonable expectation of privacy exists.

Salt Lake City Police Department

SLCPD Policy Manual

SLCPD Policy Manual

Public Safety Video Surveillance System

337.5 STORAGE AND RETENTION OF MEDIA

All downloaded media shall be stored in a secure area with access restricted to authorized persons. A recording needed as evidence shall be copied to a suitable medium and booked into evidence in accordance with established evidence procedures. All actions taken with respect to retention of media shall be appropriately documented. All downloaded and retained media shall be treated in the same manner as other evidence.

337.6 RELEASE OF VIDEO IMAGES

All recorded video images gathered by the public safety video surveillance equipment are for the official use of the Salt Lake City Police Department.

Requests for recorded video images from the public or the media shall be processed in the same manner as requests for department public records.

Requests for recorded images from other law enforcement agencies shall be referred to the supervisor of the unit responsible for the recording device that captured the recorded images for release in accordance with a specific and legitimate law enforcement purpose.

Recorded video images that are the subject of a court order or subpoena shall be processed in accordance with the established department subpoena process.

337.7 TRAINING

All department members authorized to operate or access public video surveillance systems shall receive appropriate training. Training should address state and federal law related to the use of video surveillance equipment and privacy.

337.8 REVISIONS

Enacted: March 5, 2018

Service Animals

338.1 PURPOSE AND SCOPE

Service animals play an important role in helping to overcome the limitations often faced by people with disabilities. The Salt Lake City Police Department recognizes this need and is committed to making reasonable modifications to its policies, practices, and procedures in accordance with Title II of the Americans with Disabilities Act of 1990 (ADA) to permit the use of service animals that are individually trained to assist a person with a disability.

338.2 SERVICE ANIMALS

The ADA defines a service animal as any dog or miniature horse that is individually trained to do work or perform tasks for the benefit of an individual with a disability, including a physical, sensory, psychiatric, intellectual or other mental disability. The work or tasks performed by a service animal must be directly related to the owner's disability (28 CFR 35.104).

338.2.1 USE OF SERVICE ANIMALS

Some service animals may be readily identifiable. However, many do not have a distinctive symbol, harness or collar. Service animals are not pets and may be trained by an individual or organization to assist people with disabilities.

Service animals may be used in a number of ways to provide assistance, including:

- Guiding people who are blind or have low vision.
- Alerting people who are deaf or hard of hearing.
- Retrieving or picking up items, opening doors or flipping switches for people who have limited use of their hands, arms or legs.
- Pulling wheelchairs.
- Providing physical support and assisting people with stability and balance.
- Doing work or performing tasks for persons with traumatic brain injury, intellectual disabilities or psychiatric disabilities, such as reminding a person with depression to take medication.
- Alerting a person with anxiety to the onset of panic attacks, providing tactile stimulation to calm a person with post-traumatic stress disorder, assisting people with schizophrenia to distinguish between hallucinations and reality and helping people with traumatic brain injury to locate misplaced items or follow daily routines.

338.3 EMPLOYEE RESPONSIBILITIES

Service animals that are assisting individuals with disabilities are permitted in all public facilities and areas where the general public is allowed. Department members are expected to treat individuals with service animals with the same courtesy and respect that the Salt Lake City Police Department affords to all members of the public.

Salt Lake City Police Department

SLCPD Policy Manual

SLCPD Policy Manual

Service Animals

If an animal exhibits vicious behavior, poses a direct threat to the health of others or unreasonably disrupts or interferes with normal business operations an officer may direct the owner to remove the animal from the premises. Barking alone is not a threat nor does a direct threat exist if the person takes prompt, effective action to control the animal. Each incident must be considered individually and past incidents alone are not cause for excluding a service animal. Removal of a service animal may not be used as a reason to refuse service to an individual with disabilities. Members of this department are expected to provide all services as are reasonably available to an individual with the disability.

If it is apparent or if an officer is aware the animal is a service animal, the owner should not be asked any questions as to the status of the animal. If it is unclear whether an animal meets the definition of a service animal, the officer should ask the individual only the following questions:

- Is the animal required because of a disability?
- What task or service has the service animal been trained to perform?

If the individual explains that the animal is required because of a disability and has been trained to work or perform at least one task the animal meets the definition of a service animal and no further question as to the animal's status should be asked. The person should not be questioned about his/her disabilities nor should the person be asked to provide any license, certification or identification card for the service animal.

Service animals are not pets. Department members should not interfere with the important work performed by a service animal by talking to, petting, or otherwise initiating contact with a service animal.

When handling calls of a complaint regarding a service animal, members of this department should remain neutral and should be prepared to explain the ADA requirements concerning service animals to the concerned parties. Businesses are required to allow service animals to accompany their owner into all areas that other customers or members of the public are allowed.

Absent a violation of law independent of the ADA, officers should take no enforcement action beyond keeping the peace. Individuals who believe they have been discriminated against as a result of a disability should be referred to the Civil Rights Division of the U.S. Department of Justice.

338.4 REVISIONS

Enacted: March 5, 2018

Volunteer Program

339.1 PURPOSE AND SCOPE

It is the policy of this department to use qualified volunteers for specified tasks and duties in order to create efficiencies for the Department and improve services to the community. Volunteers are intended to supplement and support, rather than supplant, sworn officers and civilian personnel.

Related policies include the Chaplains Policy and the Police Explorers Policy.

339.1.1 DEFINITION OF VOLUNTEER

An individual who performs a service for the Department without promise, expectation or receipt of compensation for services rendered. This may include unpaid chaplains, unpaid reserve officers, interns, persons providing administrative support and youth involved in a law enforcement Explorer Post, among others.

339.2 VOLUNTEER MANAGEMENT

339.2.1 VOLUNTEER COORDINATOR

The Volunteer Coordinator shall be appointed by the Public Relations Director. The function of the Volunteer Coordinator is to provide a central coordinating point for effective volunteer management within the Department and to direct and assist staff and volunteer efforts to jointly provide more productive services. The Volunteer Coordinator should work with other Department staff on an ongoing basis to assist in the development and implementation of volunteer-staffed positions.

The Volunteer Coordinator, or his/her designee, shall be responsible for the following:

- (a) Recruiting, selecting and training qualified volunteers for various positions.
- (b) Facilitating the implementation of new volunteer activities and assignments.
- (c) Maintaining records for each volunteer.
- (d) Tracking and evaluating the contribution of volunteers.
- (e) Maintaining the volunteer handbook and outlining expectations, policies, and responsibilities for all volunteers.
- (f) Maintaining a record of volunteer schedules and work hours.
- (g) Completion and dissemination as appropriate of all necessary paperwork and information.
- (h) Planning periodic recognition events.
- (i) Administering discipline when warranted.
- (j) Maintaining liaison with other volunteer-utilizing programs in the community and assisting in community-wide efforts to recognize and promote volunteering.

Salt Lake City Police Department

SLCPD Policy Manual

SLCPD Policy Manual

Volunteer Program

339.2.2 RECRUITMENT

Volunteers should be recruited on a continuous and ongoing basis consistent with department policy on equal opportunity nondiscriminatory employment. A primary qualification for participation in the application process should be an interest in, and an ability to assist the Department in serving the public.

339.2.3 SCREENING

All prospective volunteers should complete the volunteer application form. The Volunteer Coordinator or designee should conduct a face-to-face interview with an interested applicant under consideration.

A documented background investigation may be completed on each volunteer applicant and shall include, but not necessarily be limited to, the following:

- (a) Traffic and criminal background check.
 - i. Fingerprints shall be obtained from all applicants and processed through the Utah Department of Public Safety.
- (b) Employment.
- (c) References.
- (d) Credit check.
- (e) A CVSA exam may be required for an applicant depending on the type of assignment.

339.2.4 TRAINING

Volunteers will be provided with an orientation program to acquaint them with personnel and the Department policies and procedures that have a direct impact on their work assignment. Volunteers shall receive a copy of the handbook for their training.

All volunteers shall comply with the rules of conduct and with all orders and directives, either oral or written, issued by the Department.

339.2.5 FITNESS FOR DUTY

No volunteer shall report to work or be on-duty when his/her judgment or physical condition has been impaired by alcohol, medication, other substances, illness or injury.

Volunteers shall report to their supervisor any changes in status that may affect their ability to fulfill their duties. This includes, but is not limited to, the following:

- (a) Driver's license
- (b) Medical condition
- (c) Arrests
- (d) Criminal investigations

All volunteers shall adhere to the guidelines set forth by this department regarding drug and alcohol use.

Salt Lake City Police Department

SLCPD Policy Manual

SLCPD Policy Manual

Volunteer Program

339.2.6 DRESS CODE

As representatives of the Department, volunteers are responsible for presenting a professional image to the community. Volunteers shall dress appropriately for the conditions and performance of their duties.

Volunteers shall conform to department-approved dress consistent with their duty assignment. Uniforms authorized for volunteers should be readily distinguishable from those worn by sworn officers.

339.3 SUPERVISION OF VOLUNTEERS

Each volunteer who is accepted to a position with the Department must have a clearly identified supervisor who is responsible for direct management of that volunteer. This supervisor will be responsible for day-to-day management and guidance of the work of the volunteer and should be available to the volunteer for consultation and assistance.

339.4 CONFIDENTIALITY

With appropriate security clearance, volunteers may have access to confidential information such as criminal histories or investigative files. Unless otherwise directed by a supervisor or departmental policy, all information shall be considered confidential.

Volunteers shall not address public gatherings, appear on radio or television, prepare any type of article for publication, act as correspondents to a newspaper or other periodical, release or divulge any information concerning the activities of the Department, or maintain that they represent the Department in such matters without permission from the proper department personnel.

339.5 PROPERTY AND EQUIPMENT

Volunteers will be issued an identification card that must be worn at all times while on-duty. Any fixed and portable equipment issued by the Department shall be for official and authorized use only. Any property or equipment issued to a volunteer shall remain the property of the Department and shall be returned at the termination of service.

339.5.1 VEHICLE USE

Volunteers assigned to duties such as property checks or other assignments that require the use of a vehicle must first complete the following:

- (a) Verification that the volunteer possesses a valid Utah Driver's License.
- (b) Verification that the volunteer carries current vehicle insurance.

The Volunteer Coordinator should ensure that all volunteers receive safety briefing updates and license and insurance verification at least once a year.

When operating a Department vehicle, volunteers shall obey all rules of the road, including seat belt requirements. Smoking is prohibited in all Department vehicles.

Volunteers shall not operate a marked patrol car.

Salt Lake City Police Department

SLCPD Policy Manual

SLCPD Policy Manual

Volunteer Program

339.5.2 RADIO USAGE

Volunteers will be provided with radios that are programmed specifically for the volunteer program. A basic radio procedure course will be taught to all volunteers during their initial training.

339.6 INJURIES

Volunteers will follow all departmental policies and procedures regarding injuries sustained while officially acting as a Department volunteer. To ensure proper notifications and procedures are followed volunteers shall be familiar with the following:

- Communicable Diseases Policy
- Occupational Disease and Work-Related Injuries Reporting Policy and Procedure

339.7 DISCIPLINARY PROCEDURES/TERMINATION

A volunteer may be removed from the volunteer program at the discretion of the Chief of Police or the Volunteer Coordinator. Volunteers shall have no property interests in their continued appointment. However, if a volunteer is removed for alleged misconduct, the volunteer will be afforded an opportunity solely to clear his/her name through a liberty interest hearing (otherwise known as a name-clearing hearing) which shall be limited to a single appearance before the Chief of Police or authorized designee.

Volunteers may resign from volunteer service with the Department at any time. It is requested that volunteers who intend to resign provide advance notice of their departure and a reason for their decision.

The Watch Commander may, with identifiable reason, relieve a Volunteer from their responsibilities with instructions to contact their Volunteer Coordinator at a designated time.

339.8 REVISIONS

Enacted: March 5, 2018

Off-Duty Law Enforcement Actions

340.1 PURPOSE AND SCOPE

The decision to become involved in a law enforcement action when off-duty can place an officer as well as others at great risk and must be done with careful consideration. This policy is intended to provide guidelines for officers of the Salt Lake City Police Department with respect to taking law enforcement action while off-duty.

340.2 POLICY

Initiating law enforcement action while off-duty is generally discouraged. Officers should not attempt to initiate enforcement action when witnessing minor crimes. Such incidents should be promptly reported to the appropriate law enforcement agency.

Officers are not expected to place themselves in unreasonable peril. However, any sworn member of this department who becomes aware of an incident or circumstance that he/she reasonably believes poses an imminent threat of serious bodily injury or death, or significant property damage may take reasonable action to minimize the threat.

When public safety or the prevention of major property damage requires immediate action, officers should first consider reporting and monitoring the activity and only take direct action as a last resort.

Officers should remember that their authority as a peace officer may not extend to actions taken outside their jurisdiction unless authorized by law (Utah Code § 77-9-3).

340.2.1 INCIDENTS OF PERSONAL INTEREST

Officers should refrain from handling incidents of personal interest, (e.g., family or neighbor disputes) and should remain neutral. In such circumstances officers should call the responsible agency to handle the matter.

340.2.2 REPORTING

Officers should cooperate fully with the agency having jurisdiction in providing statements or reports as requested or as appropriate.

340.2.3 OFF-DUTY TRAFFIC CITATIONS

Officers may issue citations for traffic violations witnessed outside of City limits, if circumstances warrant such action and are in alignment with this policy. To issue a traffic citation outside of City limits officers must use an electronic citation (e-citation machine). If an electronic citation is not possible, and officers wish to have a citation issued, assistance will be requested from an officer in the jurisdiction where the violation occurred.

Officers are reminded that if they on-view an incident while off-duty, they must receive prior approval from the on-duty Watch Commander or designee, when practicable, to perform work in excess of 15 minutes duration (see the Overtime Compensation Requests Policy).

Salt Lake City Police Department

SLCPD Policy Manual

SLCPD Policy Manual

Off-Duty Law Enforcement Actions

340.3 FIREARMS

Officers of this department may carry firearms while off-duty in accordance with federal regulations and department policy. All firearms and ammunition must meet guidelines as described in the department Firearms Policy. When carrying firearms while off-duty, officers shall also carry their department-issued metal badge and identification.

Firearms should not be carried by any officer who has consumed an amount of an alcoholic beverage, taken any drugs or medications, or any combination thereof that would tend to adversely affect the officer's senses or judgment (Utah Code § 76-10-528).

340.4 OTHER CONSIDERATIONS

When encountering a non-uniformed officer in public, uniformed officers should wait for acknowledgement by the non-uniformed officer in case he/she needs to maintain an undercover capability.

340.5 NON-SWORN RESPONSIBILITIES

Non-sworn personnel should not become involved in any law enforcement actions while off-duty except to notify the local law enforcement authority and remain at the scene, if safe and practicable.

340.6 REVISIONS

Enacted: March 5, 2018

Revised: May 21, 2018

Department Use of Social Media for Public Relations

341.1 PURPOSE AND SCOPE

This policy provides guidelines to ensure that any use of social media on behalf of the Department is consistent with the department mission.

This policy does not address all aspects of social media use. Specifically, it does not address:

- Personal use of social media by department members (see the Employee Speech, Expression and Social Networking Policy).
- Use of social media in personnel processes (see the Recruitment and Selection Policy).
- Use of social media as part of a criminal investigation, other than disseminating information to the public on behalf of this department (see the Investigative Use of Social Media Policy).

341.1.1 DEFINITIONS

Definitions related to this policy include:

Social media - Any of a wide array of Internet-based tools and platforms that allow for the sharing of information, such as the department website or social networking services.

341.2 POLICY

The Salt Lake City Police Department may use social media as a method of effectively informing the public about department services, issues, investigations and other relevant events.

Department members shall ensure that the use or access of social media is done in a manner that protects the constitutional rights of all.

341.3 AUTHORIZED USERS

Only members authorized by the Chief of Police or the authorized designee may utilize social media on behalf of the Department. Authorized members shall use only department-approved equipment during the normal course of duties to post and monitor department-related social media, unless they are specifically authorized to do otherwise by their supervisors.

The Chief of Police may develop specific guidelines identifying the type of content that may be posted. Any content that does not strictly conform to the guidelines should be approved by a supervisor prior to posting.

Requests to post information over department social media by members who are not authorized to post should be made through the member's chain of command.

341.4 AUTHORIZED CONTENT

Only content that is appropriate for public release, that supports the department mission and conforms to all department policies regarding the release of information may be posted.

Salt Lake City Police Department

SLCPD Policy Manual

SLCPD Policy Manual

Department Use of Social Media for Public Relations

Examples of appropriate content include:

- (a) Announcements.
- (b) Tips and information related to crime prevention.
- (c) Investigative requests for information.
- (d) Requests that ask the community to engage in projects that are relevant to the department mission.
- (e) Real-time safety information that is related to in-progress crimes, geographical warnings or disaster information.
- (f) Traffic information.
- (g) Press releases.
- (h) Recruitment of personnel.

341.4.1 INCIDENT-SPECIFIC USE

In instances of active incidents where speed, accuracy and frequent updates are paramount (e.g., crime alerts, public safety information, traffic issues), the Public Information Officer or the authorized designee will be responsible for the compilation of information to be released, subject to the approval of the Incident Commander.

341.5 PROHIBITED CONTENT

Content that is prohibited from posting includes, but is not limited to:

- (a) Content that is abusive, discriminatory, inflammatory or sexually explicit.
- (b) Any information that violates individual rights, including confidentiality and/or privacy rights and those provided under state, federal or local laws.
- (c) Any information that could compromise an ongoing investigation.
- (d) Any information that could tend to compromise or damage the mission, function, reputation or professionalism of the Salt Lake City Police Department or its members.
- (e) Any information that could compromise the safety and security of department operations, members of the Department, victims, suspects or the public.
- (f) Any content posted for personal use.
- (g) Any content that has not been properly authorized by this policy or a supervisor.
- (h) Personal information of an officer, or the officer's immediate family member, without written permission.

Any member who becomes aware of content on this department's social media site that he/she believes is unauthorized or inappropriate should promptly report such content to a supervisor. The supervisor will ensure its removal from public view and investigate the cause of the entry.

Salt Lake City Police Department

SLCPD Policy Manual

SLCPD Policy Manual

Department Use of Social Media for Public Relations

341.5.1 PUBLIC POSTING

The Department allows posting by the public on some of its social media platforms. However, agreement to user terms and conditions, which specify proper interactions with the platforms, is required. The terms and conditions also give the Department authority to hide or delete comments that contain prohibited content.

341.6 MONITORING CONTENT

The Public Relations Director should review, at least annually, the use of department social media and report to the Chief of Police on, at a minimum, the resources being used, the effectiveness of the content, any unauthorized or inappropriate content, and the resolution of any issues.

341.7 RETENTION OF RECORDS

The Public Relations Director will work with the City Recorder's Office to establish a method of ensuring that public records generated in the process of social media use are retained in accordance with established records retention schedules.

341.8 TRAINING

Authorized members should receive training that, at a minimum, addresses legal issues concerning the appropriate use of social media sites, as well as privacy, civil rights, dissemination and retention of information posted on department sites.

341.9 REVISIONS

Enacted: March 5, 2018

Revised: December 10, 2018

Native American Graves Protection and Repatriation

342.1 PURPOSE AND SCOPE

This policy is intended to ensure the protection and security of ancient or historic grave sites, including notification of personnel responsible for cultural items, in compliance with the Native American Graves Protection and Repatriation Act (NAGPRA) (25 USC § 3001 et seq.).

342.1.1 DEFINITIONS

Definitions related to this policy include (43 CFR 10.2):

Funerary objects and associated funerary objects - Objects that, as part of the death rite or ceremony of a culture, are reasonably believed to have been placed intentionally at the time of death or later with or near individual human remains, or that were made exclusively for burial purposes or to contain human remains.

Native American human remains - The physical remains of the body of a person of Native American ancestry.

Objects of cultural patrimony - Objects having ongoing historical, traditional or cultural importance that is central to the Native American group or culture itself and therefore cannot be appropriated or conveyed by any individual, including members of the Native American group or Native Hawaiian organization. Such objects must have been considered inalienable by the Native American group at the time the object was separated from the group.

Sacred objects - Specific ceremonial objects needed by traditional Native American religious leaders for the practice of traditional Native American religions.

342.2 POLICY

It is the policy of the Salt Lake City Police Department that the protection of Native American human remains, funerary objects, associated funerary objects, sacred objects or objects of cultural patrimony is the responsibility of all members. Such protection includes minimizing destruction, contamination, inadvertent disruption or complicated custody transfer processes.

342.3 COMPLIANCE WITH THE NATIVE AMERICAN GRAVES PROTECTION AND REPATRIATION ACT

Upon discovery or arrival upon a scene where it reasonably appears that a Native American grave, human remains, funerary objects, associated funerary objects, sacred objects or objects of cultural patrimony are exposed or otherwise unsecured, members shall secure the site in the same manner as a crime scene. All activity at the scene other than scene preservation activity must cease (43 CFR 10.4).

No photography or video recording may be permitted by the media or any group or individual who may wish to exhibit the remains.

Salt Lake City Police Department

SLCPD Policy Manual

SLCPD Policy Manual

Native American Graves Protection and Repatriation

Without delay, the appropriate agency or group shall be notified to respond and take control of the scene. These include the following (43 CFR 10.4):

- Federal land - Appropriate agency at the U.S. Department of the Interior or U.S. Department of Agriculture
- State land/Private land - Antiquities Section of the Utah Division of State History (Utah Code 9-8-304 et seq.)
- Tribal land - Responsible Indian tribal official

342.4 EVIDENCE AND PROPERTY

If the location has been investigated as a possible homicide scene prior to identification as a NAGPRA site, investigators shall work with other appropriate agencies and individuals to ensure the proper transfer and repatriation of any material collected. Members shall ensure that any remains or artifacts located at the site are expediently processed (43 CFR 10.6).

342.5 REVISIONS

Enacted: March 5, 2018

Diversion Programs

343.1 PURPOSE AND SCOPE

The purpose of this policy is to describe the various diversion programs the Salt Lake City Police Department provides and participates in.

343.2 POLICY

Across the United States, criminal justice systems manage large numbers of people with rates of criminality, substance use, and mental health disorders exponentially higher than the general population. In order to generate the greatest return to the community in terms of cost savings, public safety, long-term health and personal stability for individuals involved with the criminal justice system, and overall community improvement, it is the policy of this Department to participate in diversion programs when feasible.

343.3 COMMUNITY CONNECTION TEAM

Law enforcement personnel have increasingly become the first responders to individuals in serious mental health and/or substance use disorder crises. Traditional law enforcement approaches to these issues sometimes lead to individuals being introduced into the criminal justice system without receiving needed treatment. The Salt Lake City Police Department created the Community Connection Team to assist officers in some of these more complex and challenging situations by offering additional options where possible.

The Community Connection Team is staffed by Master's level clinicians, substance abuse counselors, social service workers, and support personnel. The team targets its services toward individuals experiencing homelessness, in mental health crisis, and/or in substance use disorder crisis by providing:

- Intermittent, short-term therapeutic intervention;
- Education to officers on non-criminal justice alternatives for individuals in crisis;
- Care coordination between agencies;
- Access to detox beds;
- Access to medical, mental health, and/or substance use disorder treatment;
- Case management;
- Assistance with navigation of the behavioral health system; and
- Crisis intervention.

343.3.1 REFERRAL TO COMMUNITY CONNECTION TEAM

[Salt Lake City Police Department Procedure Manual: 317.2 REFERRAL TO COMMUNITY CONNECTION TEAM](#)

Salt Lake City Police Department

SLCPD Policy Manual

SLCPD Policy Manual

Diversion Programs

343.4 DETOXIFICATION CENTER

Officers may use a detoxification center as an alternative to booking a publicly intoxicated person into jail.

A person being arrested for public intoxication can be transported to the detoxification center in lieu of being booked into jail if:

- They are not being charged with a felony or class A misdemeanor;
- No medical problem is evident;
- The individual is not unmanageable or belligerent; and
- There are beds available at the detoxification center.

343.4.1 PLACEMENT IN DETOXIFICATION CENTER

[Salt Lake City Police Department Procedure Manual: 317.3 PLACEMENT IN DETOXIFICATION CENTER](#)

343.5 PROMISING YOUTH PROJECT

The Salt Lake City Police Department, in an effort to reduce gang involvement, gang-related crimes, and divert at-risk individuals away from gang association, operates a Promising Youth Project (PYP).

PYP gang prevention specialists work with clients to reduce the prevalence of research-based identified risk factors that are associated with gang involvement, and increase protective factors to encourage clients to cease gang involvement. Program activities work to discourage association, involvement, and identification with street gangs, and to encourage participation in pro-social programs, activities, and opportunities. Services and opportunities are provided in areas such as:

- Education
- Employment
- Counseling
- Mentoring
- Mental Health
- Substance Abuse
- Family Stability

343.5.1 REFERRAL TO PYP

PYP targets residents of Salt Lake City, of any any gender, race, and/or ethnicity, ranging in ages between 10-21 years old who have been identified as at-risk, associating with gangs, and/or are a gang member.

Salt Lake City Police Department

SLCPD Policy Manual

SLCPD Policy Manual

Diversion Programs

The program manager will review all referrals and determine if the client meets the criteria needed to participate in PYP.

[Salt Lake City Police Department Procedure Manual: 317.4 REFERRAL TO PROMISING YOUTH PROJECT \(PYP\)](#)

343.6 REVISIONS

Enacted: March 5, 2018

Revised: June 21, 2018

Revised: December 17, 2018

Public Order Unit

344.1 PURPOSE AND SCOPE

This policy provides guidance for the use and deployment of the Salt Lake City Police Department's Public Order Unit (POU).

344.1.1 DEFINITIONS

Deployment - A POU Deployment occurs when members of the POU stage for, or respond to, an event or incident of civil unrest (this can be with or in their individual Kit).

Kit - The specific physical accouterments worn by members of the POU to provide enhanced protection beyond their level 2 or 3A body armor.

High Threat Event - An event where the potential for civil unrest is elevated, and a specific indication, intelligence, or foreshadowing exists to believe such unrest will occur.

Low Threat Event - An event where the potential for civil unrest is present, but no specific indication, intelligence, or foreshadowing exists to believe such unrest will occur.

POU Commander - The POU Commander is the Special Operations Division Motor/Special Events Lieutenant.

Presence - A POU presence occurs when members of the POU staff an event.

POU Assist - A POU Assist occurs when another agency's POU (or equivalent) requests the Salt Lake City Police Department's POU augment their own deployment strategy by sending any number of its members to a location not owned or operated by the City.

Mutual Aid Deployment - A Mutual Aid Deployment occurs when an outside agency that does not have a POU (or equivalent) formally requests assistance from the Salt Lake City Police Department's POU.

Shared Interest Deployment - A Shared Interest Deployment occurs when the Salt Lake City Police Department's POU deploys as a joint team with another agency's POU (or equivalent) in a geographical area that has overlapping jurisdiction (e.g., University of Utah, State Capitol Building, etc.).

Scheduled Event - Events where no specific indication of civil unrest is present but events where the potential of such exists; more so than any other event or secondary employment detail.(i.e., LDS Conference, Twilight Concert series, Dignitary Detail/Assignment, "Town Hall" meetings, etc.).

Serial - A serial is a standard working component of the Public Order Unit. A serial is comprised of 33 members. A POU deployment can be comprised of multiple serials.

344.2 POLICY

The Public Order Unit (POU) has been established to provide specialized law enforcement support to help facilitate citizens' first amendment rights to free speech while keeping the public's interest

Salt Lake City Police Department

SLCPD Policy Manual

SLCPD Policy Manual

Public Order Unit

of safety and order during planned or spontaneous events. The Public Order Unit will also serve as a response option to general instances of civil unrest.

344.3 PUBLIC ORDER UNIT STRUCTURE

The Public Order Unit is under the command of the Operations Bureau. The chain of command is as follows:

- Chief of Police
- Assistant Chief of Police
- Operations Bureau Deputy Chief
- Special Operations Division Captain
- Motor/Special Events Lieutenant
- POU Sergeant(s)
- Officer(s)

The Public Order Unit consists of squads of six officers and one sergeant. Twenty-eight officers, four sergeants, and one commander make up a complete serial. A serial is a standard working component of the Public Order Unit and shall be the deployment used on a High Threat Event.

Although the default deployment strength of the POU is at least one serial, situations may arise where POU staffing is desired, but a full serial is not needed (for example, for presence and/or monitoring of Low Threat Events). In these circumstances, the POU Commander may allow for a less-than-complete deployment of a serial, recognizing that this option is the exception rather than the rule, as well as understanding that formal POU action will be hindered and/or not possible if the need arises.

344.4 PUBLIC ORDER UNIT CALL-OUT PROCEDURE

If a call-out of POU is necessary, proper procedure shall be followed. [Salt Lake City Police Department Procedure Manual: 316.2 PUBLIC ORDER UNIT CALL-OUT](#)

Additionally, if a POU call-out leads to a mass arrests situation, proper procedure shall be followed. [Salt Lake City Police Department Procedure Manual: 415.3 MASS ARRESTS PROCEDURE](#)

344.5 POU ASSIST

In a POU Assist, this department's POU will meet deployment requirements by utilizing its members at the formal request of, and in a combined effort with, another agency's POU as agreed upon by this department's POU Commander. In such situations both operational command and unit responsibilities/assignments will be retained by and made by the other agency's POU Commander.

Salt Lake City Police Department

SLCPD Policy Manual

SLCPD Policy Manual

Public Order Unit

344.6 MUTUAL AID DEPLOYMENT

In a Mutual Aid Deployment, this department's POU should first attempt to meet deployment requirements by utilizing its own members first. This is for purposes of continuity and clear operational command/responsibilities.

344.7 SHARED INTEREST DEPLOYMENT

In a Shared Interest Deployment, this department's POU will meet deployment requirements by utilizing its members in a combined effort with another agency's POU, as determined by the POU Commander. In these situations, operational command and unit responsibilities will be predetermined if practicable.

344.8 VIDEOGRAPHY

All officers shall be equipped with their own Axon Taser camera on POU deployments. However, the use of a designated videographer(s) is an immense benefit to the Department to document and gather visual evidence. A dedicated videographer gives a clearer picture of the totality of the event. The purpose of the videographer is to gather information that can be used to assist in the prosecution of persons arrested, and identify individuals that might be arrested later. The videographer documents the behavior of the crowd, conditions officers are subjected to, and dispels false accusations and complaints made against officers of this department. The videographer will be paired with a safety officer utilizing an intermediate length shield while on the line. The two will work as a single unit and move around behind the line of officers to gather available video footage. If possible, two videographer teams should be used on deployments to best optimize the chances of gathering all possible visual evidence.

After an event, the video footage gathered by the videographers can be invaluable in civil and criminal court proceedings. Video recordings will be booked into evidence under a designated case number for the event.

344.9 GRENADIER

Public Order Unit officers designated as grenadiers should be cross trained in the two forms of less lethal armament the Department has approved for use by the Public Order Unit. POU is authorized to use the following less lethal systems:

- (a) 40 mm launcher
- (b) FN 303 Launcher

Public Order Unit grenadiers shall abide by the Department's Use of Force Policy when deploying these less lethal weapon systems.

344.10 USE OF FORCE

All Public Order Unit officers will abide by this department's Use of Force Policy.

Every officer is responsible for the documentation of force used on individuals regardless of crowd size. Given the dynamic nature of civil unrest/violent protests it is not always feasible to detain individuals when force is used on them. Officers should make every reasonable attempt to obtain

Salt Lake City Police Department

SLCPD Policy Manual

SLCPD Policy Manual

Public Order Unit

the pertinent information of the subject force was used on, to include type of force and injury sustained from the force. All POU officers will write a supplemental report documenting their individual actions taken during a POU deployment.

344.11 TRAINING

Before being deployed in any disturbance-related situation, all POU officers will be required to attend the 40 hour initial/basic POU training. Until such training can be obtained, officers assigned to POU will be limited to working Scheduled Events unless resources are depleted to the point that no other POU officers are available.

After the initial training, all POU officers will be required to attend supplemental training each year as determined by the POU Commander.

344.12 REVISIONS

Enacted: March 5, 2018

Transgender Individuals

345.1 PURPOSE AND SCOPE

Recognizing that transgender individuals represent a portion of the greater community to which the Department provides service, this policy is a guideline in providing service to the transgender community.

345.2 POLICY

Consistent with the Mission Statement and Core Values of the Salt Lake City Police Department, all members will safeguard the rights of all people, without consideration of a person's actual or perceived race, color, sex, gender, gender identity/expression, religious creed, sexual orientation, age, national origin, ancestry, handicap or disability. These goals cannot be met unless all persons are treated with the courtesy and dignity inherently due every person as a human being. Therefore, all members will act, speak, and conduct themselves in a professional manner towards an individual, or group of individuals, who identify as transgender or an associated subgroup. Members will not make discourteous or disrespectful remarks regarding another person's actual or perceived gender, gender identity/expression, or sexual orientation.

345.3 GENERAL GUIDELINES

During interactions with transgender individuals, members will:

- (a) Respectfully treat individuals in a manner appropriate to their gender, or gender identity/expression.
- (b) Use pronouns requested by the individual (i.e., "she, her, hers" for those identifying as female, and "he, him, his" for those identifying as male). If one is uncertain about which gender the individual wishes to be addressed, one may respectfully ask the individual.
- (c) If requested, refer to the individual by their preferred name rather than what is indicated on their government-issued identification.

Members will not:

- (a) Stop, detain, or frisk an individual for the sole reason of determining gender or gender identity/expression.
- (b) Require proof of gender or challenge a person's gender identity or expression unless legally necessary.
- (c) Use language that a reasonable person would find demeaning or derogatory with regard to an individual's actual or perceived gender, gender identity/expression, or sexual orientation.
- (d) Disclose an individual's gender identity or sexual orientation to other arrestees, members of the public, or other government personnel, absent a proper law enforcement purpose.
- (e) Make assumptions about an individual's sexual orientation based upon their gender or gender identity/expression.

Salt Lake City Police Department

SLCPD Policy Manual

SLCPD Policy Manual

Transgender Individuals

- (f) Use a person's gender or gender identity/expression as reasonable suspicion that the individual is or has engaged in the commission of a crime, absent any other articulable facts.

These guidelines do not outweigh an officer's obligation to avoid endangering themselves or another person in order to comply with these guidelines.

For official documentation purposes, officers should document individual details as recorded on a government-issued identification or in a database such as the DMV or BCI systems.

345.4 ARRESTEES

Unless an individual has completed gender conforming/affirming surgery or court-ordered name change, any arrestee's gender and/or name shall be documented by their government-issued identification or what is documented in a database such as the DMV or BCI systems. Any name used by the arrestee in reference to their gender identity/expression should be listed as an alias.

If an individual has no identification and an identifying database is unavailable, the arresting officer may ask the individual if they have male or female genitalia and classify the individual based upon the response.

In the event of uncertainty regarding the classification of any arrestee, the arresting officer will consult their supervisor for clarification.

Refer to the Custodial Searches Policy for information regarding searches of transgender individuals.

345.5 REVISIONS

Enacted: March 5, 2018

Revised: March 8, 2018

Forensic Blood Draws

345.1 PURPOSE AND SCOPE

This policy provides guidance for forensic blood draws. Related policies include the Traffic Collision Policy and the Communicable Diseases Policy.

345.2 POLICY

Some investigations require taking a blood sample from individuals for forensic purposes. Depending on the circumstances, either the Medical Examiner or specially trained Salt Lake City Police Department phlebotomists will perform blood draws for the Police Department. Blood draws will only be allowed if:

- (a) Written consent is given [See attachment: Blood Draw Consent Form.pdf](#); or
- (b) A warrant has been obtained; or
- (c) There is a judicially recognized exception to a warrant.
 - i. Implied consent shall not be utilized as a method for obtaining a blood draw.
 - ii. The existence of judicially recognized exceptions (such as exigent circumstances) in cases of blood draws is very narrow and will be scrutinized heavily by the courts on a case-by-case basis. Courts have ruled that the natural metabolism of blood alcohol does not establish a per se exigency that would justify a blood draw without consent, and courts disfavor the practice of obtaining warrantless blood draws when an e-warrant can be obtained relatively quickly. If an officer believes that a judicially recognized exception to a warrant exists in a particular case, that officer shall contact the Watch Commander. The Watch Commander will be responsible for authorizing or denying a blood draw under a judicially recognized exception.

Blood samples of a deceased victim/suspect shall be drawn by the Medical Examiner, usually after the body has been removed from the scene. All other blood samples should be drawn by department phlebotomists. [Salt Lake City Police Department Procedure Manual: 318.2 PHLEBOTOMIST PROGRAM](#)

Refer to the Traffic Collisions Policy for requirements regarding blood draws for fatal traffic accidents.

Department phlebotomists may assist other agencies requesting blood draws if approved by the Watch Commander. Department personnel should not write search warrants for other agencies requesting blood draws, unless circumstances require such assistance and approval is obtained from the Watch Commander.

345.3 BLOOD DRAW PROCEDURES

[Salt Lake City Police Department Procedure Manual: 318.2.1 REQUESTING A BLOOD DRAW](#)

[Salt Lake City Police Department Procedure Manual: 318.2.2 OBTAINING/DOCUMENTING A BLOOD DRAW](#)

Salt Lake City Police Department

SLCPD Policy Manual

SLCPD Policy Manual

Forensic Blood Draws

[Salt Lake City Police Department Procedure Manual: 318.3 BLOOD DRAW WARRANTS](#)

[Salt Lake City Police Department Procedure Manual: 318.2.3 FORMS](#)

345.4 NON-COMPLIANT INDIVIDUALS

A blood draw shall not be obtained from a non-compliant individual without a search warrant.

Pursuant to the legal authorization provided by a search warrant, officers may use reasonable force to retrieve a blood sample. Officers will use only the amount of force necessary to fulfill the obligations of the warrant.

Officers are responsible to restrain an individual in a manner that allows the department phlebotomist to draw blood in a safe manner, for both the officer(s) and the individual the blood is being drawn from. Officers should restrain the individual on the provided gurneys at the PSB and Pioneer Precinct, in or near the respective intoxilyzer rooms. This will allow officers to more easily restrain a non-compliant individual, as well as provide safety for the individual. Officers shall call for additional assistance during the restraining process if needed. A supervisor shall be present any time an individual is being restrained for the purpose of a blood draw.

345.5 SOURCE PATIENT TESTING (BLOOD BORNE EXPOSURES)

In the event of a significant exposure to an employee, Department phlebotomists are authorized to perform source patient blood draws for submission to the University of Utah Medical Center. Refer to the Communicable Diseases Policy and Procedure for additional information.

345.6 MEDICAL FACILITY TRANSFER OF BLOOD

Occasionally, this department may be asked to assist in the transfer of blood from one facility to another if the transfer must be expeditious to save a life. This department will cooperate when requested to assist with such a transfer. The transfer may be made using emergency equipment.

345.7 REVISIONS

Enacted: March 5, 2018

Revised: May 21, 2018

Law Enforcement Activity in Hospitals

346.1 PURPOSE AND SCOPE

The purpose of this policy is to outline proper procedures for conducting law enforcement activity (e.g., blood draws, warrant service, evidence collection, witness/suspect interviews, etc.) in hospitals. This policy applies to all hospitals, with the exception of the University of Utah Hospital, which has more specific procedures due to having a jointly adopted policy and a full-time University of Utah Police Department presence (See the University of Utah Hospitals & Salt Lake City Police Department Procedure).

346.1.1 DEFINITIONS

House Supervisor – The on-duty Clinical Nursing Supervisor for a hospital. There is a House Supervisor on-duty at hospitals 24 hours a day, 7 days a week. House Supervisors have the authority to act on behalf of hospital administrations and oversee clinical operations. House Supervisors also have appropriate training in responding to law enforcement requests regarding patients.

In-Patient – For the purpose of this policy, the term “in-patient” refers to any individual who is admitted to a Hospital for care/treatment, outside of an Emergency Department.

346.2 POLICY

In order to facilitate efficient coordination of duties between police and medical personnel, it is the policy of the Salt Lake City Police Department to follow appropriate procedures whenever practicable when conducting law enforcement activities at a hospital. This policy shall in no way be construed as to restrict officers from taking life-saving actions in emergency situations.

346.3 IN-PATIENT PROCEDURES

346.3.1 IN-PATIENT – NOT IN CUSTODY

When an officer responds to a hospital to conduct law enforcement activity with an in-patient who is not presently in custody, the officer should first make contact with the hospital’s House Supervisor, or equivalent administrator. The officer will explain their needs and present any legal process (i.e., search warrant), if applicable.

If there is disagreement between the officer and the House Supervisor, the officer shall contact their Sergeant and/or Watch Commander to facilitate resolution.

This procedure does not apply when a hospital has initiated contact with law enforcement and has asked them to respond to the hospital. In these instances, officers will respond to the area requesting the police response and follow standard Department protocol.

346.3.2 IN-PATIENT – IN CUSTODY

In-patients in the custody of the Salt Lake City Police Department will be guarded and handled per regular Department hospital guard duty procedures (see the Hospital Guard Duty Procedure).

Salt Lake City Police Department

SLCPD Policy Manual

SLCPD Policy Manual

Law Enforcement Activity in Hospitals

If an in-patient who is not presently in custody needs to be placed in custody, officers will follow the process under the IN-PATIENT – NOT IN CUSTODY section to facilitate direction to the individual's location and proper advisement of the House Supervisor.

346.4 EMERGENCY DEPARTMENT PROCEDURES

Interactions between police personnel and Emergency Department staff are inherently different from other areas of a hospital due to the nature of law enforcement and medical services provided in an Emergency Department. As such, procedures that differ from other areas of a hospital are necessary in order to ensure the efficiency of services and the safety of all present.

When conducting law enforcement activity in an Emergency Department, officers must keep two points in mind:

1. There is a charge nurse on-duty in an Emergency Department 24 hours a day, 7 days a week. It is the charge nurse's responsibility to maintain overall management of the Emergency Department. To help facilitate this function, whenever practicable, officers will notify the charge nurse of their presence and purpose in the Emergency Department (this includes Crime Lab Personnel – this notification may be made in advance by the officer requesting Crime Lab).
2. Many hospitals have police officers working security in their Emergency Department. If that is the case in a particular hospital, the investigating officer should make a reasonable effort to inform the officer working security of their purpose and presence.

Listed below are specific procedures for common circumstances that officers face when conducting law enforcement activity in an Emergency Department. Law enforcement and emergency medicine are dynamic fields of work, and it is difficult to predict every possible situation that might present itself in this environment. If a situation presents itself that is not explicitly covered by these procedures, officers shall use their best judgment, and whenever practicable (i.e., a situation that is not an emergency requiring immediate action), consult with the Emergency Department charge nurse and/or police officer working security before taking action. If there is disagreement between an officer and Emergency Department personnel about an officer's request for patient access or information, the officer will request that the hospital's House Supervisor be paged and respond. The officer shall not argue with Emergency Department personnel to resolve the issue, and will wait to resolve any problems that arise with the House Supervisor. If the situation cannot be resolved between the officer and the House Supervisor, the officer shall contact his/her Sergeant and/or Watch Commander to facilitate resolution.

346.4.1 REQUESTS FOR SERVICE

When a hospital contacts the Department requesting a police response due to a victim's presence in the Emergency Department (e.g., sexual assault victim, domestic violence victim, assault victim, etc.), the responding officer(s) will respond to the Emergency Department to take the initial report and conduct the initial investigation per standard protocols. The responding officer(s) will explain to the personnel who grant them entrance the purpose of their presence. Normal protocol of letting Emergency Department personnel and/or the police officer working security know of the officer's presence and purpose will be followed. Notification to the House Supervisor is not necessary.

Salt Lake City Police Department

SLCPD Policy Manual

SLCPD Policy Manual

Law Enforcement Activity in Hospitals

346.4.2 ENTRY WITH SUBJECTS IN CUSTODY

When officers enter an Emergency Department with individuals who are in custody (e.g., civil commitments, arrested persons, detained suspects, etc.), the officer will stay with that individual as safety, legal, and evidentiary circumstances require until the officer's official duties are completed. No official notification to the House Supervisor needs to be made. Officers will follow normal protocol of letting Emergency Department personnel and/or the police officer working security know that the individual is being civilly committed or is otherwise in custody.

If the individual who is in custody needs to be moved to another area of the hospital for treatment (i.e., an Operating Room), the officer shall stay with that individual as safety, legal, and evidentiary circumstances require. In such situations, Emergency Department personnel or the police officer working security will notify the House Supervisor of the movement, if the hospital's policies require such notification.

346.4.3 ENTRY WITH VICTIMS RECEIVING EMERGENCY TREATMENT

Often, officers respond to an Emergency Department with individuals who need emergency medical treatment due to being victims of violent crime (e.g., shootings, stabbings, etc.). The timely collection of evidence and statements in these cases is extremely important. An officer may enter the Emergency Department in these circumstances without notifying the House Supervisor. Normal protocol of letting Emergency Department personnel and/or the police officer working security know of the officer's presence and purpose will be followed.

If the victim needs to be moved to another area of the hospital for treatment, the officer shall stay with that individual as safety, legal, and evidentiary circumstances require. In such situations, Emergency Department personnel or the police officer working security will notify the House Supervisor of the movement, if the hospital's policies require such notification.

346.4.4 DECEASED PERSONS

At times, officers are required to guard bodies of deceased persons for evidentiary and chain-of-custody purposes. Officers may enter an Emergency Department in these situations without notifying the House Supervisor. Normal protocol of letting Emergency Department personnel and/or the police officer working security know of the officer's presence and purpose will be followed. Emergency Department personnel or the police officer working security will notify the House Supervisor if the hospital's policies require such notification.

346.4.5 OTHER NON-CUSTODIAL INTERACTIONS

When officers find it necessary to contact an individual in an Emergency Department who is not in custody, and who does not fall into one of the above listed categories, the responding officer shall first make contact with the Emergency Department charge nurse or the House Supervisor. The officer will explain their needs and present any legal process (i.e., search warrant), if applicable.

If there is disagreement between the officer and the Emergency Department charge nurse, the officer will request that the hospital's House Supervisor be paged and respond. The officer shall not argue with Emergency Department personnel to resolve the issue, and will wait to resolve the

Salt Lake City Police Department

SLCPD Policy Manual

SLCPD Policy Manual

Law Enforcement Activity in Hospitals

disagreement with the House Supervisor. If the situation cannot be resolved between the officer and the House Supervisor, the officer shall contact his/her Sergeant and/or Watch Commander to facilitate resolution.

346.5 REVISIONS

Enacted: March 5, 2018

Investigative Photographing by Officers

347.1 PURPOSE AND SCOPE

This policy provides guidance for the use of Department-issued cell phones for documenting evidence. Officers will not use personal cell phones or cameras to take photographs of evidence.

347.2 POLICY

When utilizing a Department-issued cell phone with the Axon capture application, officers of the Salt Lake City Police Department are authorized to take photographs in the following investigations:

- (a) Domestic violence investigations that do not involve injuries (i.e., property damage only).
- (b) Vandalism not amounting to a felony.
- (c) Damage to City property – this includes Category 2 officer-involved traffic accidents.
- (d) Traffic collisions where Accident Investigators are not responding – this includes collisions with Alpha and/or Bravo injuries.
- (e) Traffic collisions involving UTA vehicles (TRAX and Bus) not requiring Accident Investigators – this includes collisions with Alpha and/or Bravo injuries.
- (f) Thefts and retail thefts.
- (g) Simple possession cases (e.g., drugs, paraphernalia, financial documents, ID's, etc.).
- (h) Stolen vehicles.
- (i) Other types of investigations not requiring Crime Lab processing, measurements, or other forensic analysis.

Crime Lab should be called if processing, measurements, or other forensic analysis is needed, such as traffic collisions involving Charlie or above injuries, Hit and Run investigations, and any domestic violence or assault investigations involving injuries.

If a Department-issued cell phone is not available, officers may use a Department camera and upload the images to Evidence.com.

347.3 PROCEDURE

Officers will familiarize themselves with the Axon capture application on their Department-issued cell phone. Officers will also familiarize themselves with the attached training material regarding taking evidentiary photographs with a cell phone camera. [See attachment: Investigative Photography by Officers.pdf](#)

When conducting an investigation, officers will determine if the case requires photographs. If the investigation meets the criteria set forth in this policy, an officer should take the required photographs with a Department-issued cell phone through the axon capture application.

Salt Lake City Police Department

SLCPD Policy Manual

SLCPD Policy Manual

Investigative Photographing by Officers

Officers should take overall and mid-range photos to show the scene/person/vehicle, before close ups are taken of individual items. This gives perspective to what investigators and others are looking at when reviewing the photographs. Officers will verify that the pictures are of sufficient quality and capture what is needed to be useful as evidence. When a sufficient amount of photographs have been taken, the officer should mark which photos to upload, add a case number in the proper format, add the description of the crime, and press the upload button. This should be completed prior to clearing from the call.

If for some reason photographs cannot be taken in the Axon capture application and are uploaded to evidence.com, officers shall delete the photographs from their Department-issued cell phone after the uploading is complete and it is verified that the photos did in fact upload successfully. This should be completed prior to clearing from the call.

347.4 EQUIPMENT

Officers with a Department-issued cell phone are responsible for the appropriate use and care of the phone. If a cell phone is lost or damaged, it shall be reported in accordance with the Department-Owned and Personal Property Policy.

347.5 REVISIONS

Enacted: March 5, 2018

Revised: January 22, 2018

Revised: May 21, 2018

Stalking

348.1 PURPOSE AND SCOPE

The purpose of this policy is to establish uniform police department procedures for responding to and handling stalking incidents.

348.1.1 DEFINITIONS

Course of conduct - Two or more acts directed at or toward a specific person, including (Utah Code 76-5-106.5(1)(b)):

- i. Acts in which the actor follows, monitors, observes, photographs, surveils, threatens, or communicates to or about a person, or interferes with a person's property:
 1. directly, indirectly, or through any third party; and
 2. by any action, method, device, or means; or
- ii. The actor engages in any of the following acts or causes someone else to engage in any of these acts:
 1. approaches or confronts a person;
 2. appears at the person's workplace or contacts the person's employer or coworkers;
 3. appears at a person's residence or contacts a person's neighbors, or enters property owned, leased, or occupied by a person;
 4. sends material by any means to the person or for the purpose of obtaining or disseminating information about or communicating with the person to a member of the person's family or household, employer, coworker, friend, or associate of the person;
 5. places an object on or delivers an object to property owned, leased, or occupied by a person, or to the person's place of employment with the intent that the object be delivered to the person; or
 6. uses a computer, the Internet, text messaging, or any other electronic means to commit an act that is a part of the course of conduct.

Reasonable person - A reasonable person in the victim's circumstances (Utah Code 76-5-106.5(1)(e)).

Stalking - A person is guilty of stalking when they (Utah Code 76-5-106.5(2); 76-5-106.5(3)):

- i. Intentionally or knowingly engages in a course of conduct directed at a specific person and knows or should know that the course of conduct would cause a reasonable person:
 1. to fear for the person's own safety or the safety of a third person; or
 2. to suffer other emotional distress; or
- ii. Intentionally or knowingly violates:

Salt Lake City Police Department

SLCPD Policy Manual

SLCPD Policy Manual

Stalking

1. A stalking injunction issued pursuant to Utah Code 77-3a *et seq.*; or
2. A permanent criminal stalking injunction issued pursuant to Utah Code 76-5-106.5.

Text messaging - A communication in the form of electronic text or one or more electronic images sent by the actor from a telephone or computer to another person's telephone or computer by addressing the communication to the recipient's telephone number (Utah Code 76-5-106.5(1)(g)).

348.2 POLICY

Stalking cases present a unique and ongoing threat to the victim, the seriousness of which is difficult to predict and may involve ongoing behavior by a suspect that can last for years. Due to the difficult and dangerous nature of this conduct, it shall be the policy of this police department to investigate all stalking reports in a manner that enhances protection of the victim and facilitates the arrest of the stalker when proper. Emphasis shall be on providing as many measures of safety for the victim as reasonably possible. Members shall convey sensitivity to victims, determine if probable cause exists for an arrest, and take appropriate action. The officer shall make efforts to ensure that victims are informed of all available services within the department and the community.

Officers shall make an initial report for any incident of stalking.

348.3 INITIAL RESPONSE

Many stalking cases come to the attention of the police early in the stalking behaviors, and appropriate stalker interventions by law enforcement can often stop the stalking behaviors before serious crimes or injuries occur. However, not all cases are referred or readily identified through standard means or channels. When investigating a stalking complaint, members must determine whether the report is an isolated incident or repeated conduct. It is not uncommon for a victim to put up with harassing behavior for some time before finally calling law enforcement. Therefore, whenever a report is made members should inquire about prior behavior. When inquiring about prior behavior, the responding officer should determine whether any prior police reports have been made and in what jurisdiction. The officer should also ask if any friends or family members have filed reports of crimes believed to have been committed by the perpetrator. Common stalking behaviors include, but are not limited to:

- (a) Violations of any protective order by visits to the victim's home or any other location frequented by the victim.
- (b) Telephone calls to the victim (harassing, threatening, obscene, or otherwise).
- (c) Mail, cards, letters, or gifts to the victim.
- (d) Trespassing.
- (e) Burglary of the victim's home (there may not be forced entry as the stalker may have a key).
- (f) Following the victim on foot or in a vehicle.
- (g) Showing up at the victim's place of employment or other frequented establishments.

Salt Lake City Police Department

SLCPD Policy Manual

SLCPD Policy Manual

Stalking

- (h) Spying or monitoring of the victim's activities.
- (i) Making slanderous statements or false reports concerning the victim.
- (j) Delivery of objects to the victim intended to cause fear (objects, taken out of context, may seem innocuous to outsiders).
- (k) Threats made to the victim (either direct, veiled, or conditional).
- (l) Vandalism or theft of the victim's property, home, vehicle, workplace, or vandalism to the property, etc. of any friend or family member who assists the victim, specifically by allowing the victim to stay at their home.
- (m) Vandalism affecting the security of the victim's home, such as unscrewing outside lights or disabling the alarm system.
- (n) Disabling the victim's vehicles.
- (o) Filing "change of address" forms at the post office under the victim's name in order to intercept the victim's mail.
- (p) Harassing or threatening the victim by use of computers and the Internet.

348.3.1 PREVIOUSLY REPORTED INCIDENTS

When responding to a stalking complaint, the investigating officer shall review the department's records containing prior reports, civil protection orders, temporary protection orders, etc. to determine whether there is any record of the parties having been involved previously in a stalking incident or some other related offense, or having a protection order in effect.

348.3.2 EVIDENCE COLLECTION

Investigating officers shall seize any tangible items of evidence from the victim that corroborate the stalking behavior. Things to be seized may include:

- (a) Any letters or notes written by the suspect to the victim. Keep latent print and DNA possibilities in mind when handling these items.
- (b) Any objects sent to the victim or left for the victim, including "gifts".
- (c) Any voice mail, text messages, or other types of phone messages. Document time and date. Make a recording or take photographs of these messages to submit as evidence.
- (d) Any log/journal/diary of suspect contacts that the victim may have been keeping which shows any dates, times, and locations of suspect encounters.
- (e) Any security video (from grocery stores, banks, parking lot/workplace security cameras, the victim's home, etc.) that are evidence of the suspect stalking the victim should be collected.
- (f) Documentation of email sent by the stalker to the victim.

Elements of stalking in Utah State Code include fear for one's safety and/or emotional distress. It is therefore important to document any evidence of the victim's response to the harassment which shows "state of mind." For example, has the victim:

- (a) Moved to a new location?

Salt Lake City Police Department

SLCPD Policy Manual

SLCPD Policy Manual

Stalking

- (b) Obtained a new phone number?
- (c) Told friends, coworkers, or family about the harassment?
- (d) Told building security at home, work, or school?
- (e) Given photos of the suspect to security?
- (f) Asked to be escorted to the parking lot and work site?
- (g) Changed work schedule or route to work?
- (h) Stopped visiting places previously frequented?
- (i) Taken self-defense courses?
- (j) Bought pepper spray?
- (k) Purchased a gun?
- (l) Installed an alarm system?
- (m) Bought a guard dog?

348.3.3 STATEMENTS

The responding officer should document the following by thoroughly interviewing the victim about the suspect:

- (a) Any prior threats made to the victim (direct or indirect). Develop a timeline of the stalking behaviors towards the victim.
- (b) Any actual pursuit or following of the victim.
- (c) Any history of violence against the victim or others.
- (d) Prior mental illness history of the suspect.
- (e) Substance abuse problems of the suspect.
- (f) Suspect's possession of weapons.
- (g) Any history of filed protective orders against the suspect or protective order violations by the suspect.
- (h) Any unsolicited correspondence, threatening or nonthreatening, from the suspect to the victim.
- (i) Threats of murder and/or suicide by the suspect.
- (j) Any acts of vandalism or arson committed by the suspect against the victim or anyone connected to the victim.
- (k) Is the victim in fear?

If witnesses are present, obtain witness statements.

If children are present, interview children with knowledge of the incident(s) utilizing proper child forensic interviewing techniques.

Salt Lake City Police Department

SLCPD Policy Manual

SLCPD Policy Manual

Stalking

348.3.4 SUSPECT

Every stalking investigation should include a thorough research of the suspect's prior criminal history and/or prior contacts with law enforcement.

Law enforcement contact can be an effective means of deterring stalkers, particularly in cases where the victim and the suspect had some prior relationship and where the stalker is not suffering from mental illness. This type of stalker is more likely to understand an officer's explanation of the potential consequences of his/her continued harassment or escalation of stalking behaviors. This type of warning contact is most appropriate when the behavior does not yet constitute a violation of law. It can include contact by phone or in-person. Often, a face-to-face visit with the suspect may be all it takes to have a deterrent effect on the inappropriate behavior.

If probable cause exists for the charge of stalking, and an arrest is made, officers shall check the offender's criminal history for possible charging enhancements (Utah Code 76-5-106.5(7); 76-5-106.5(8)).

348.4 STALKING INJUNCTIONS

While it is recognized that stalking injunctions may not always be effective in actually protecting a victim, the primary advantage to having such an order against the suspect is that it allows him/her to be immediately arrested when a violation occurs. Officers shall arrest any person whom the officer has probable cause to believe is in violation of any stalking injunction issued by a court of competent jurisdiction, whether or not the violation occurred in the presence of the officer. Officers shall check the offender's criminal history for possible charging enhancements (Utah Code 76-5-106.5(7); 76-5-106.5(8)). The wishes of the victim or petitioner in a stalking injunction violation are immaterial in determining whether an arrest is to be made.

348.4.1 EX PARTE CIVIL STALKING INJUNCTION

An Ex Parte Civil Stalking Injunction is valid and enforceable only after it has been personally served on the respondent by a peace officer. After service, this order is valid until issuance of the Civil Stalking Injunction, or until the order is dismissed at a court hearing.

348.4.2 CIVIL STALKING INJUNCTION

If the Respondent of an Ex Parte Civil Stalking Injunction does not request an evidentiary hearing within 10 days after being served, a Civil Stalking Injunction is automatically issued by the court and is in effect upon issuance with no further notice to the Respondent.

If a hearing is requested by the Respondent and at the hearing the Petitioner is granted the Civil Stalking Injunction, it is immediately in effect upon issuance with no further notice to or service upon the Respondent.

348.4.3 SERVICE OF A CIVIL STALKING INJUNCTION

The courts require that Civil Stalking Injunctions be served by a sheriff or constable (the terms "sheriff" or "constable" do not include police officers) through the Salt Lake County Sheriff's Office. Alternative service, however, is allowed in certain circumstances:

Salt Lake City Police Department

SLCPD Policy Manual

SLCPD Policy Manual

Stalking

- (a) If the protected person finds herself/himself where the respondent is, the protected person is urged to contact the law enforcement agency having jurisdiction at her/his location. If a police officer responds, that officer can serve the injunction packet that should be in the protected person's possession.
- (b) If the protected person finds herself/himself in an emergency situation that would warrant calling 911, the protected person is urged to contact 911 to receive emergency assistance. After police officers have dealt with the emergency situation, the officers can then make service of the injunction on the respondent.

If a police officer does make alternative service, the officer must complete the service stamp found in the upper right hand corner of the injunction. The officer must complete the Return of Service by filling in all blank lines and including a signature and title.

After completion of service, the serving officer shall immediately take the Return of Service to the Records Unit. The Records Unit shall:

- (a) Immediately send the Return of Service to the Salt Lake County Sheriff's Office so that the Sheriff's Office can recall the original sent to them by the court for service.
- (b) Update the statewide system to show the injunction as served.
- (c) Scan a copy of the Return of Service into the corresponding case and route the case to the Domestic Violence Unit.

348.4.4 IMPORTANT POINTS TO REMEMBER ABOUT CIVIL STALKING INJUNCTIONS

- (a) The petitioner in a Civil Stalking Injunction cannot criminally violate the order. Only the respondent can criminally violate the order.
- (b) Violation of a Civil Stalking Injunction constitutes the criminal offense of stalking in addition to the violation of the Civil Stalking Injunction.
- (c) An arrest for a violation of any type of Civil Stalking Injunction requires a new case and case number.
- (d) Officers shall enforce all Civil Stalking Injunctions issued by any court in the state of Utah. This requirement applies regardless of the jurisdiction in which the order was issued, or the location of the victim or the perpetrator, so long as the violation occurred in SLCPD's jurisdiction.
- (e) An initial report shall be completed on all reports of Civil Stalking Injunction violations. Each violation requires a separate case number.

348.4.5 CRIMINAL STALKING INJUNCTION

Criminal Stalking Injunctions are issued by a court following a conviction for stalking. The victim of the stalking does not petition for the order.

An initial report shall be completed on all reports of Criminal Stalking Injunction violations. Each violation requires a separate case number.

Salt Lake City Police Department

SLCPD Policy Manual

SLCPD Policy Manual

Stalking

348.5 VICTIM ASSISTANCE FOR STALKING

Officers investigating allegations of stalking should take reasonable steps to protect the victim and any family or household member. This includes the following (Utah Code 76-5-106.5):

- (a) Victims shall be provided with the Salt Lake City Police Department blue victim information card, even if the incident may not rise to the level of a crime.
 - i. If the report is being taken telephonically, provide the victim with the information on the card and document the provision.
- (b) Recognize that a victim's behavior and actions may be affected.
- (c) Stand by for a reasonable amount of time when an involved person requests law enforcement assistance while removing essential items of personal property.
- (d) Ask the victim whether he/she has a safe place to stay. Assist in arranging to transport the victim to an alternate shelter if the victim expresses a concern for his/her safety or if the officer determines that a need exists. Victim advocates may assist with this process (see the Victim and Witness Assistance Policy).
- (e) Make reasonable efforts to ensure that children or dependent adults who are under the supervision of the victim are being properly cared for.
- (f) If applicable, officers shall seize the weapon or weapons involved in the alleged stalking.

348.6 REVISIONS

Enacted: December 17, 2018

Chapter 4 - Patrol Operations

Patrol Function

400.1 PURPOSE AND SCOPE

The purpose of this policy is to define the functions of the Patrol Divisions of the Department to ensure intra-department cooperation and information sharing.

400.1.1 FUNCTION

Officers will generally patrol in clearly marked vehicles, patrol assigned jurisdictional areas of Salt Lake City, respond to calls for assistance, act as a deterrent to crime, enforce state and local laws and respond to emergencies 24 hours per day seven days per week.

Patrol will generally provide the following services within the limits of available resources:

- (a) Patrol that is directed at the prevention of criminal acts, traffic violations and collisions, the maintenance of public order, and the discovery of hazardous situations or conditions.
- (b) Crime prevention activities such as residential inspections, business inspections, community presentations.
- (c) Calls for service, both routine and emergency in nature.
- (d) Investigation of both criminal and non-criminal acts.
- (e) The apprehension of criminal offenders.
- (f) Community Oriented Policing and problem solving activities such as citizen assists and individual citizen contacts of a positive nature.
- (g) The sharing of information between the Patrol Divisions and other divisions within the Department, as well as other outside governmental agencies.
- (h) The application of resources to specific problems or situations within the community, which may be improved or resolved by Community Oriented Policing and problem solving strategies.
- (i) Traffic direction and control.

400.2 PATROL INFORMATION SHARING PROCEDURES

The following guidelines are intended to develop and maintain intra-department cooperation and information flow between the various divisions of the Salt Lake City Police Department.

400.2.1 SALT LAKE INFORMATION CENTER (SLIC)

The Salt Lake Information Center (SLIC) will be the central unit for information exchange. Criminal information and intelligence reports can be submitted to the SLIC for distribution to all divisions within the Department through daily and special bulletins.

Salt Lake City Police Department

SLCPD Policy Manual

SLCPD Policy Manual

Patrol Function

400.2.2 CRIME REPORTS

A crime report may be completed by any patrol officer who receives criminal information. The report will be processed and forwarded to the appropriate division for retention or follow-up investigation.

400.2.3 PATROL LINE-UP

Patrol supervisors, detective sergeants and special unit sergeants are encouraged to share information as much as possible. All supervisors and/or officers will be provided an opportunity to share information at the daily patrol Line-Up as time permits.

400.2.4 SMARTFORCE

SmartForce™ is the department's online information sharing program where information about current crime trends, updates on major investigations, patrol checks, intelligence reports, information on wanted persons, etc. is posted. To facilitate the timely exchange of information, Patrol supervisors (as well as other department supervisors) should regularly review information on SmartForce™ with their personnel and make updates when applicable.

400.3 REVISIONS

Enacted: March 26, 2018

Bias-Based Policing

401.1 PURPOSE AND SCOPE

This policy provides guidance to department members that affirms the Salt Lake City Police Department's commitment to policing that is fair and objective (Utah Code 10-3-913; Utah Code 17-22-2; Utah Code 53-1-108).

Nothing in this policy prohibits the use of specified characteristics in law enforcement activities designed to strengthen the department's relationship with its diverse communities (e.g., cultural and ethnicity awareness training, youth programs, community group outreach and partnerships).

401.1.1 DEFINITIONS

Definitions related to this policy include:

Biased-based policing - An inappropriate reliance on characteristics such as race, ethnicity, national origin, religion, sex, sexual orientation, gender identity or expression, economic status, age, cultural group, disability or affiliation with any non-criminal group (protected characteristics) as the basis for providing differing law enforcement service or enforcement.

401.2 POLICY

The Salt Lake City Police Department is committed to providing law enforcement services to the community with due regard for the racial, cultural or other differences of those served. It is the policy of this department to provide law enforcement services and to enforce the law equally, fairly, objectively and without discrimination toward any individual or group.

401.3 BIASED-BASED POLICING PROHIBITED

Bias-based policing is strictly prohibited.

However, nothing in this policy is intended to prohibit an officer from considering protected characteristics in combination with credible, timely and distinct information connecting a person or people of a specific characteristic to a specific unlawful incident, or to specific unlawful incidents, specific criminal patterns or specific schemes.

401.4 MEMBER RESPONSIBILITIES

Every member of this department shall perform his/her duties in a fair and objective manner.

401.4.1 REASON FOR CONTACT

Officers contacting a person shall be prepared to articulate sufficient reason for the contact, independent of the protected characteristics of the individual.

To the extent that written documentation would otherwise be completed (e.g., arrest report, Field Interview (FI) card), the involved officer should include those facts giving rise to the contact, as applicable.

Except for required data-collection forms or methods, nothing in this policy shall require any officer to document a contact that would not otherwise require reporting.

Salt Lake City Police Department

SLCPD Policy Manual

SLCPD Policy Manual

Bias-Based Policing

401.5 SUPERVISOR RESPONSIBILITIES

Supervisors should monitor those individuals under their command for compliance with this policy and shall handle any alleged or observed violation of this policy in accordance with the Complaints Against Personnel and Disciplinary Action Policy.

- (a) Supervisors should discuss any issues with the involved officer and his/her supervisor in a timely manner.
- (b) Supervisors shall initiate investigations of any actual or alleged violations of this policy.
- (c) Supervisors should take prompt and reasonable steps to address any retaliatory action taken against any member of this department who discloses information concerning bias-based policing.

401.6 ADMINISTRATION

The Operations Bureau Deputy Chief should review the efforts of the Department to provide fair and objective policing and submit an annual report, including public concerns and complaints, and any corrective measures taken, if applicable, to the Chief of Police. The annual report should not contain any identifying information about any specific complaint, member of the public, or officer. It should be reviewed by the Chief of Police to identify any changes in training or operations that should be made to improve service.

Supervisors should review the annual report and discuss the results with those they are assigned to supervise.

401.7 TRAINING

All sworn personnel will receive initial training, as well as on-going annual training, on fair and objective policing, including legal aspects.

401.8 REVISIONS

Enacted: March 26, 2018

Revised: April 27, 2018

Line-Up Training

402.1 PURPOSE AND SCOPE

Line-Up training is generally conducted at the beginning of the officer's assigned shift. Line-Up provides an opportunity for important exchange between employees and supervisors. A supervisor generally will conduct Line-Up; however officers may conduct Line-Up for training purposes with supervisor approval.

Line-Up should accomplish, at a minimum, the following basic tasks:

- (a) Briefing officers with information regarding daily patrol activity, with particular attention given to unusual situations and changes in the status of wanted persons, stolen vehicles and major investigations.
- (b) Notifying officers of changes in schedules and assignments.
- (c) Notifying officers of, and training officers on, new departmental policies and/or procedures or changes in department policies and/or procedures.
- (d) Reviewing recent incidents for training purposes.
- (e) Providing training on a variety of subjects.

402.2 PREPARATION OF MATERIALS

The supervisor conducting Line-Up is responsible for preparation of the materials necessary for a constructive briefing. Supervisors may delegate this responsibility to a subordinate officer in his/her absence or for training purposes.

402.3 RETENTION OF LINE-UP TRAINING RECORDS

Line-Up training shall be documented in the department's online training system by the supervisor(s) providing the training, or the supervisor(s) present at the Line-Up training if the training has been delegated to a subordinate officer.

402.4 REVISIONS

Enacted: March 26, 2018

Crime and Disaster Scene Integrity

403.1 PURPOSE AND SCOPE

The purpose of this policy is to provide guidance in handling a major crime or disaster.

403.2 POLICY

It is the policy of the Salt Lake City Police Department to secure crime or disaster scenes so that evidence is preserved, and to identify and mitigate the dangers associated with a major crime (e.g., homicide, officer-involved critical incident, robbery, sexual assault, etc.) or disaster scene for the safety of the community and those required to enter or work near the scene.

403.3 SCENE RESPONSIBILITY

The first officer at the scene of a crime or major incident is generally responsible for the immediate safety of the public and preservation of the scene. Officers shall also consider officer safety and the safety of those persons entering or exiting the area, including those rendering medical aid to any injured parties. Once an officer has assumed or been assigned to maintain the integrity and security of the crime or disaster scene, the officer shall maintain the crime or disaster scene until he/she is properly relieved by a supervisor or other designated person.

403.4 FIRST RESPONDER CONSIDERATIONS

The following list generally describes the first responder's function at a crime or disaster scene. This list is not intended to be all-inclusive, is not necessarily in order and may be altered according to the demands of each situation:

- (a) Broadcast emergency information, including requests for additional assistance and resources.
- (b) Provide for the general safety of those within the immediate area by mitigating, reducing or eliminating threats or dangers.
- (c) Locate or identify suspects and determine whether dangerous suspects are still within the area.
- (d) Provide first aid to injured parties if it can be done safely.
- (e) Evacuate the location safely as required or appropriate.
- (f) Secure the inner perimeter.
- (g) Protect items of apparent evidentiary value.
- (h) Secure an outer perimeter.
- (i) Identify potential witnesses.
- (j) Start a Major Incident Log noting critical times and all personnel allowed access.

403.4.1 WITNESSES

The initial interview of persons at the crime scene by investigating patrol officers shall be aimed at determining who the actual witnesses are, receiving and documenting available suspect

Salt Lake City Police Department

SLCPD Policy Manual

SLCPD Policy Manual

Crime and Disaster Scene Integrity

information, and gathering other facts relevant to the case. Information obtained that needs immediate follow-up attention shall be conveyed as soon as possible to the assigned detective(s).

403.4.2 SUSPECTS

The initial interview of suspects by patrol officers should be aimed at determining identity and obtaining sufficient information to develop probable cause to affect an arrest.

Unless directed otherwise by the Watch Commander or a supervisor, follow-up investigators will handle additional interviews and formal statements.

403.4.3 SCENE SECURITY

Access to a major crime scene shall be limited to persons essential for the investigation of the incident. Upon arrival, initial officers should identify everyone present at the scene, and remove unnecessary personnel.

Anyone attempting to enter the scene will be challenged by the officers assigned to scene security. Access will be denied to those who should not be present. Supervisory and Command Staff personnel may enter at their discretion after notifying the Incident Commander. Officers in charge of scene security, in addition to initiating a Major Incident Log, shall include in their reports the identity of Fire Department and/or ambulance personnel present at the scene. The Major Incident Log should be given to the detective relieving the officer from this assignment.

403.5 SEARCHES

Officers arriving at crime or disaster scenes are often faced with the immediate need to search for and render aid to victims, and to determine if suspects are present and continue to pose a threat. Once officers are satisfied that no additional suspects are present and/or there are no injured persons to be treated, those exigent circumstances will likely no longer exist. Officers should thereafter secure the scene and conduct no further search until additional or alternate authority for the search is obtained, if needed, such as consent or a search warrant.

403.5.1 CONSENT

When possible, officers should seek properly documented consent to search from authorized individuals. However, in the case of serious crimes or major investigations, it may be prudent to also obtain a search warrant.

403.6 EXECUTION OF HEALTH ORDERS

Any sworn member of the Salt Lake City Police Department may assist in enforcement of orders of restriction issued by the Department of Health or local health authority for the purpose of preventing the spread of any contagious, infectious or communicable disease (Utah Code 26-6b-3; Utah Code 26-6b-3.2).

403.7 REVISIONS

Enacted: March 26, 2018

Ride-Along Program

404.1 PURPOSE AND SCOPE

The Ride-Along Program provides an opportunity for citizens to experience the law enforcement function firsthand. This policy provides the requirements, approval process and hours of operation for the Ride-Along Program.

404.1.1 ELIGIBILITY

Attempts will be made to accommodate all interested persons, however, any applicant may be disqualified without cause.

The following factors will be considered in disqualifying an applicant and are not limited to:

- Being under 18-years of age unless the rider is a registered and active Police Explorer (see the Police Explorer Policy)
 - Exceptions to the above may be made with Division Commander approval
 - Any rider under 18-years of age must have the written consent of their parent or guardian prior to participating in the ride
- Prior criminal history
 - Any felony conviction
 - Any misdemeanor conviction in the last 4 years
 - Any drug conviction in the past 5 years
 - Any offense against government or government employees (i.e., resisting arrest, interfering with an officer, false information to a police officer, etc.)
 - Currently on probation or parole for a criminal offense
- Pending criminal action
- Pending lawsuit against the Department
- Denial by any supervisor

Upon a showing of good cause, the Chief of Police, or his or her designee, has the discretion to waive one or more of the above disqualifiers.

404.1.2 AVAILABILITY

The Ride-Along Program is available on most days of the week, with certain exceptions. Each ride-along participant will be limited to one 4-hour ride-along, which will begin no earlier than 07:00 and end no later than 02:00. The ride-along may be extended up to 10 hours with supervisor approval. Exceptions to this schedule may be made as approved by the Chief of Police, Division Commander or Watch Commander.

Participants must meet the officer they are riding with at a Department facility to begin their ride-along. If the officer the participant is riding with is busy on a call for service, the participant can

Salt Lake City Police Department

SLCPD Policy Manual

SLCPD Policy Manual

Ride-Along Program

be driven to that location by another officer at the discretion of the Watch Commander or shift Sergeant.

404.1.3 RELATIVES

Relatives of an officer may ride with that officer, so long as they meet all necessary guidelines set forth by the Department for the ride-along program.

404.2 PROCEDURE TO REQUEST A RIDE-ALONG

All persons requesting to ride with an officer must complete and submit a Ride-Along Request Form and Waiver. The necessary forms can be found on the Salt Lake City Police Department's website under the resources tab. Information requested will include a valid ID or Utah driver's license, address, and telephone number. If the participant is under 18-years of age, a parent/guardian must sign the Ride-Along Waiver Form.

Department members who receive a Ride-Along Request Form and Waiver will follow proper procedure for routing the documents for approval/denial, scheduling, and documentation. [Salt Lake City Police Department Procedure Manual: 409.2 RIDE-ALONG FORM PROCEDURE](#)

If the ride-along is denied after the request has been made, a representative of the Department will contact the applicant and advise of the denial.

404.2.1 PROGRAM RESTRICTIONS

Once approved, civilian ride-alongs will be allowed to ride no more than once a year. An exception would apply to the following: Explorers, VIP's, Chaplains, police applicants, and all others with approval of the Watch Commander.

404.2.2 SUITABLE ATTIRE

Any person approved to ride-along is required to be suitably dressed in attire that appears neat and clean. Sandals, tank tops, shorts and ripped or torn blue jeans are not permitted. The Watch Commander or field supervisor may refuse a ride-along to anyone not properly dressed.

Civilian and non-sworn ride-along participants, with or without a concealed carry permit, shall not be armed.

404.2.3 ARMED PEACE OFFICER RIDE-ALONGS

A certified officer from another agency may be armed during a ride-along, but the shift Sergeant and Watch Commander must be notified of such prior to the ride-along beginning. Furthermore, a certified officer from another agency shall not represent himself or herself as a peace officer or participate in any law enforcement activity, except as emergency circumstances may require.

404.2.4 RIDE-ALONG CRIMINAL HISTORY CHECK

All ride-along applicants are subject to a criminal history check. The criminal history check may include a local records check and a state records check through the Bureau of Criminal Investigation (BCI) prior to their approval as a ride-along with a law enforcement officer, provided

Salt Lake City Police Department

SLCPD Policy Manual

SLCPD Policy Manual

Ride-Along Program

that the ride-along is not an employee of the Salt Lake City Police Department or currently certified peace officer.

404.2.5 GENDER

When possible, riders will be assigned to an officer of the same gender.

404.3 OFFICER'S RESPONSIBILITY

The officer shall advise the dispatcher that a ride-along is present in the vehicle before going into service.

The assigned officer will exercise discretion to provide the highest level of protection and safety to the rider.

As soon as time and circumstances permit, the officer should brief the rider on when and how to call for help if necessary. The officer should also brief the participant on what to do and what not to do on the ride-along, which should include the following:

- (a) All participants shall wear a vehicle safety belt while traveling in a vehicle which is in motion.
- (b) Cameras and tape recorders are prohibited during a ride-along. Phones which are capable of audio or video recording are allowed, provided the devices are not used in such a manner.
- (c) The rider may not engage in any police activities unless specifically directed by the officer.
- (d) The rider must immediately follow all instructions given by officers.
- (e) Safety considerations.

404.4 CONTROL OF RIDE-ALONG

The assigned employee shall maintain control over the ride-along at all times and instruct him/her in the conditions that necessarily limit their participation. These instructions should include:

- (a) The ride-along shall wear the provided "Police Observer" badge at all times.
- (b) The ride-along will follow the directions of the officer.
- (c) The ride-along will not become involved in any investigation, handling of evidence, or discussions with victims or suspects.
- (d) The ride-along may terminate the ride at any time. If the ride-along interferes with the performance of the officer's duties, the officer may terminate the ride-along and return the observer to his/her home or to the station.
- (e) Ride-alongs may be allowed to continue riding during the transportation and booking process provided this does not jeopardize their safety.
- (f) Officers will not allow any ride-alongs to be present in any residence or situation that would jeopardize their safety or cause undue stress or embarrassment to a victim or any other citizen.

Salt Lake City Police Department

SLCPD Policy Manual

SLCPD Policy Manual

Ride-Along Program

404.5 INJURY TO RIDE-ALONG PARTICIPANT

Should an injury occur to a ride-along participant, appropriate medical treatment will be summoned. In addition, the assigned officer will follow proper procedure for making required notifications and completing required reports. [Salt Lake City Police Department Procedure Manual: 409.3 RIDE-ALONG INJURY PROCEDURE](#)

404.6 REVISIONS

Enacted: March 26, 2018

Hazardous Material Response

405.1 PURPOSE AND SCOPE

Exposure to hazardous materials presents potential harm to department members and the public. This policy outlines the responsibilities of members who respond to these events and the factors that should be considered while on-scene, including the reporting of exposures and supervisor responsibilities.

405.1.1 DEFINITIONS

Definitions related to this policy include:

Hazardous material - A substance which by its nature, containment and reactivity, has the capability of inflicting harm during exposure; characterized as being toxic, corrosive, flammable, reactive, an irritant or strong sensitizer and thereby posing a threat to health when improperly managed.

405.2 POLICY

It is the policy of the Salt Lake City Police Department to respond to hazardous material emergencies with due regard for the safety of the public and those members responding to such incidents.

405.3 HAZARDOUS MATERIAL RESPONSE

Members may encounter situations involving suspected hazardous materials, such as at the scene of a traffic collision, chemical spill or fire. When members come into contact with a suspected hazardous material, they should take certain to protect themselves and other persons.

The fire department is the agency trained and equipped to properly respond to and mitigate most incidents involving hazardous materials and biohazards.

Responders should not perform tasks or use equipment without proper training. A responder entering the area may require decontamination before he/she is allowed to leave the scene, and should be evaluated by appropriate technicians and emergency medical services personnel for signs of exposure.

405.4 CONSIDERATIONS

The following steps should be considered at any scene involving suspected hazardous materials:

- (a) Make the initial assessment of a potentially hazardous material from a safe distance.
- (b) Implement the seven critical tasks for incident stabilization:
 1. Establish communications and control.
 2. Identify the hot zone.
 3. Establish the inner perimeter.
 4. Establish the outer perimeter.

Salt Lake City Police Department

SLCPD Policy Manual

SLCPD Policy Manual

Hazardous Material Response

5. Establish a unified command post.
 6. Establish a staging area.
 7. Request resources.
- (c) Notify Dispatch, appropriate supervisors, the appropriate fire department and hazardous response units.
1. Provide weather conditions, wind direction, a suggested safe approach route and any other information pertinent to responder safety.
- (d) Wear personal protective equipment (PPE), being cognizant that some hazardous material can be inhaled.
- (e) Remain upwind, uphill and at a safe distance, maintaining awareness of weather and environmental conditions, until the material is identified and a process for handling has been determined.
- (f) Attempt to identify the type of hazardous material from a safe distance using optical aids (binoculars or spotting scopes) if they are available. Identification can be determined by:
1. Placards with the use of an emergency response guidebook.
 2. Driver's statements or shipping documents from the person transporting the material.
 3. Information obtained from any involved person with knowledge regarding the hazardous material. Information should include:
 - i. The type of material.
 - ii. How to secure and contain the material.
 - iii. Any other information to protect the safety of those present, the community and the environment.
- (g) Make reasonable efforts to secure the scene to prevent access from unauthorized individuals and to protect and identify any evidence.
- (h) Begin evacuation of the immediate and surrounding areas, dependent on the material. Voluntary evacuation should be considered; mandatory evacuation may be necessary and will depend on the type of material.
- (i) Establish a decontamination area when needed.

405.5 REPORTING EXPOSURE

Department members who believe they have been exposed to a hazardous material shall immediately report the exposure to a supervisor. Each exposure shall be documented by the member in an incident report that shall be forwarded via chain of command to the Watch Commander as soon as practicable. Should the affected member be unable to document the exposure for any reason, it shall be the responsibility of the notified supervisor to complete the report.

Salt Lake City Police Department

SLCPD Policy Manual

SLCPD Policy Manual

Hazardous Material Response

Injury or illness caused or believed to be caused from exposure to hazardous materials shall be reported the same as any other on-duty injury or illness.

405.5.1 SUPERVISOR RESPONSIBILITIES

When a supervisor has been informed that a member has been exposed to a hazardous material, he/she shall ensure that immediate medical treatment is obtained and appropriate action is taken to mitigate the exposure or continued exposure.

405.6 TRAINING

The Training Lieutenant should ensure that awareness level training for events involving hazardous materials is provided periodically.

405.7 REVISIONS

Enacted: March 26, 2018

Hostage and Barricade Incidents

406.1 PURPOSE AND SCOPE

The purpose of this policy is to provide guidelines for situations where officers have legal cause to contact, detain or arrest a person, and the person refuses to submit to the lawful requests of the officers by remaining in a structure or vehicle and/or by taking a hostage.

The scope of this policy is not intended to address all variables that officers encounter during their initial response or when a hostage or barricade situation has developed. This policy does not require or purport to recommend specific strategies or tactics for resolution as each incident is a dynamic and rapidly evolving event.

406.1.1 DEFINITIONS

Definitions related to this policy include:

Barricade situation - An incident shall be considered a barricaded subject when:

- The suspect is believed to be armed; and
- The suspect is believed to have been involved in a criminal act, or is a significant threat to the lives and safety of citizens and/or police; and
- The suspect is in a position of advantage, affording cover and concealment, or is contained in an open area and the presence or approach of police officers would be unsafe; and
- The suspect refuses to submit to custody.

Hostage situation - An incident shall be considered a hostage situation when any person is held by another against their will by force or threat of force, expressed or implied. In the case of hostage situations, the lives of the hostage(s) will be paramount and the Department will make every reasonable effort to effect their safe release.

406.2 POLICY

It is the policy of the Salt Lake City Police Department to address hostage and barricade situations with due regard for the preservation of life and balancing the risk of injury, while obtaining the safe release of hostages, apprehending offenders and securing available evidence.

406.3 COMMUNICATION

When circumstances permit, initial responding officers should try to establish and maintain lines of communication with a barricaded person or hostage-taker. Officers should attempt to identify any additional subjects, inquire about victims and injuries, seek the release of hostages, gather intelligence information, identify time-sensitive demands or conditions and obtain the suspect's surrender.

When available, department-authorized negotiators should respond to the scene as soon as practicable and assume communication responsibilities. Negotiators are permitted to exercise

Salt Lake City Police Department

SLCPD Policy Manual

SLCPD Policy Manual

Hostage and Barricade Incidents

flexibility in each situation based upon their training, the circumstances presented, suspect actions or demands and the available resources.

406.3.1 EMERGENCY COMMUNICATIONS

Should circumstances at the scene permit, a supervisor or negotiator may contact the Attorney General or the District Attorney for approval to intercept any wire, electronic or oral communication and/or to use an eavesdropping device (e.g., camera or audio device) when there is an immediate threat of death or serious bodily injury to any person or to national security. The supervisor or negotiator who has been granted approval shall ensure that an application for an appropriate court order approving the interception is sought within 48 hours after the interception begins (Utah Code 77-23a-10(7)).

406.4 FIRST RESPONDER CONSIDERATIONS

First responding officers should promptly and carefully evaluate all available information to determine whether an incident involves, or may later develop into, a hostage or barricade situation.

The first responding officer should immediately request a supervisor's response as soon as it is determined that a hostage or barricade situation exists. Officers shall continually evaluate the situation, including the level of risk to officers, to the persons involved and to bystanders, and the resources currently available.

The handling officer should brief the arriving supervisor of the incident, including information about suspects and victims, the extent of any injuries, additional resources or equipment that may be needed, and current perimeters and evacuation areas.

When possible, the handling officer should make an effort to preserve the integrity of the scene as outlined in the Crime and Disaster Scene Integrity Policy, for follow-up investigations; however, due to the dynamic nature of these types of calls, the preservation of life takes precedence over the safeguarding of potential evidence.

406.4.1 BARRICADE SITUATION

Unless circumstances require otherwise, officers handling a barricade situation should attempt to avoid a forceful confrontation in favor of stabilizing the incident by establishing and maintaining lines of communication while awaiting the arrival of specialized personnel and trained negotiators. During the interim the following options, while not all-inclusive or in any particular order, should be considered:

- (a) Ensure injured persons are evacuated from the immediate threat area if it is reasonably safe to do so. Request medical assistance.
- (b) Assign personnel to an emergency action/arrest team to control the subject should he/she attempt to exit the building, structure or vehicle, and attack, use deadly force, attempt to escape or surrender prior to additional resources arriving.
- (c) Request additional personnel, resources and equipment as needed (e.g., canine team, air support).
- (d) Provide responding emergency personnel with a safe arrival route to the location.

Salt Lake City Police Department

SLCPD Policy Manual

SLCPD Policy Manual

Hostage and Barricade Incidents

- (e) Evacuate non-injured persons in the immediate threat area if it is reasonably safe to do so.
- (f) Attempt or obtain a line of communication and gather as much information on the subject as possible, including weapons, other involved parties, additional hazards or injuries.
- (g) Establish an inner and outer perimeter as circumstances require and resources permit to prevent unauthorized access.
- (h) Evacuate bystanders, residents, and businesses within the inner and the outer perimeter as appropriate. Check for injuries, the presence of other involved subjects, witnesses, evidence or additional information.
- (i) Determine the need for and notify the appropriate persons within and outside the Department, such as command officers and the Public Information Officer.
- (j) Restrict the radio channel the barricaded incident is being handled on
 - i. If necessary and available, establish a tactical or exclusive radio frequency for the incident.
- (k) Establish a command post.

406.4.2 HOSTAGE SITUATION

Officers presented with a hostage situation should attempt to avoid a forceful confrontation in favor of controlling the incident in anticipation of the arrival of specialized personnel and trained hostage negotiators. However, it is understood that hostage situations are dynamic and can require that officers react quickly to developing or changing threats. The following options while not all-inclusive or in any particular order should be considered:

- (a) Ensure injured persons are evacuated from the immediate threat area if it is reasonably safe to do so. Request medical assistance.
- (b) Assign personnel to an arrest team to control the subject should he/she attempt to exit the building, structure or vehicle, and attack, use deadly force, attempt to escape or surrender prior to additional resources arriving.
- (c) Establish an emergency action team in the event it becomes necessary to rapidly enter a building, structure or vehicle, such as when the suspect is using deadly force against any hostages (see the Rapid Response and Deployment Policy).
- (d) Assist hostages or potential hostages to escape if it is reasonably safe to do so. Hostages should be kept separate if practicable pending further interview.
- (e) Request additional personnel, resources and equipment as needed (e.g., canine team, air support).
- (f) Provide responding emergency personnel with a safe arrival route to the location.
- (g) Evacuate non-injured persons in the immediate threat area if it is reasonably safe to do so.
- (h) Coordinate pursuit or surveillance vehicles and control of travel routes.

Salt Lake City Police Department

SLCPD Policy Manual

SLCPD Policy Manual

Hostage and Barricade Incidents

- (i) Attempt or obtain a line of communication and gather as much information about the suspect as possible, including any weapons, victims and their injuries, additional hazards, other involved parties and any other relevant intelligence information.
- (j) Establish an inner and outer perimeter as resources and circumstances permit to prevent unauthorized access.
- (k) Evacuate bystanders, residents, and businesses within the inner and the outer perimeter as appropriate. Check for injuries, the presence of other involved subjects, witnesses, evidence or additional information.
- (l) Determine the need for and notify the appropriate persons within and outside the Department, such as command officers and the Public Information Officer (PIO).
- (m) Restrict the radio channel where the hostage incident is being handled.
 - i. If necessary and available, establish a tactical or exclusive radio frequency for the incident.

406.5 SUPERVISOR RESPONSIBILITIES

Upon being notified that a hostage or barricade situation exists, the supervisor should immediately respond to the scene, assess the risk level of the situation, establish a proper chain of command and assume the role of Incident Commander until properly relieved. This includes requesting a SWAT/ Hostage Negotiation Team (HNT) response if appropriate and informing the Tactical Commander of the circumstances. In addition, the following options, listed here in no particular order, should be considered:

- (a) Ensure injured persons are evacuated and treated by medical personnel.
- (b) Ensure the completion of necessary first responder responsibilities or assignments.
- (c) Request SWAT, crisis negotiators, specialized units, additional personnel, resources or equipment as appropriate.
- (d) Establish a command post location as resources and circumstances permit.
- (e) Designate assistants who can help with intelligence information and documentation of the incident.
- (f) Consider contacting utility and communication providers when restricting such services is being considered (e.g., restricting electric power, gas, telephone service).
- (g) Ensure adequate law enforcement coverage for the remainder of the City during the incident. The supervisor should direct non-essential personnel away from the scene unless they have been summoned by the supervisor or Dispatch.
- (h) Identify a media staging area outside the outer perimeter and have the department PIO or a designated temporary media representative provide media access in accordance with the Media Relations Policy.
- (i) Identify the need for mutual aid and the transition or relief of personnel for incidents of extended duration.
- (j) Debrief personnel and review documentation as appropriate.

Salt Lake City Police Department

SLCPD Policy Manual

SLCPD Policy Manual

Hostage and Barricade Incidents

406.6 SWAT/HOSTAGE NEGOTIATION TEAM (HNT) RESPONSIBILITIES

It will be the Incident Commander's decision, with input from the Tactical Commander, whether to deploy the SWAT/HNT during a hostage or barricade situation. Once the Incident Commander authorizes deployment, the Tactical Commander or the authorized designee will be responsible for the tactical portion of the operation. The Incident Commander shall continue supervision of the command post operation, outer perimeter security, and evacuation, media access, and support for SWAT/HNT. The Incident Commander and the Tactical Commander or the authorized designee shall maintain communications at all times.

406.7 REPORTING

Unless otherwise relieved by a supervisor or Incident Commander, the handling officer at the scene is responsible for completion and/or coordination of incident reports.

406.8 REVISIONS

Enacted: March 26, 2018

Special Weapons and Tactics (SWAT) Team

407.1 PURPOSE AND SCOPE

The Salt Lake City Police Department has established a SWAT Team, trained in the use of tactics and weapons for deployment in high-hazard situations. This policy outlines the structure, deployment, and mobilization of the SWAT Team. The SWAT Team shall keep a separate policy and procedure manual governing SWAT Team functions and equipment, in line with Department policies and procedures.

407.2 TEAM ORGANIZATION

The organizational and command structure of the Salt Lake City Police Department SWAT Team is organized as follows:

SWAT Commander - A Captain who has overall responsibility for the SWAT Team's activity and mission.

Tactical Commander - A Lieutenant who has the administrative and operational responsibility of the SWAT Team's activity and mission.

Team Leader - A Sergeant who supervises team members and coordinates with the Tactical Commander. The Team Leader is responsible for the tactical deployment of the SWAT Team and accomplishment of missions assigned by the Tactical Commander.

Assistant Team Leader - A SWAT Team member who takes leadership responsibilities in the absence of a Team Leader. Assistant Team Leaders may assume leadership roles during operational, training, or administrative situations as assigned by a Team Leader or Tactical Commander.

Team Member - An officer trained and qualified as a SWAT officer, who is part of the SWAT Team. Members of the SWAT Team are cross-trained in all areas of SWAT tactics to include: containment, entry, scout, chemical munitions, etc.

Sniper - A SWAT Team member trained in marksmanship and use of a scoped rifle.

Explosive Breacher - A SWAT Team member specially trained in the use of explosive breaching.

Crisis Negotiator - A sworn member of the SWAT Team who responds to crisis incidents as a negotiator.

407.2.1 SPECIALIZED CADRES AND COMPONENTS

Specialized cadres and components within the SWAT Team exist in order to further the SWAT Team's mission. They include:

- Sniper Cadre
- Explosive Breacher Cadre
- Climbing Cadre

Salt Lake City Police Department

SLCPD Policy Manual

SLCPD Policy Manual

Special Weapons and Tactics (SWAT) Team

- SWAT K9 Component
- Hostage Negotiations Team (HNT)

407.2.2 AUTHORIZED STRENGTH AND COMPOSITION

SWAT Team staffing is authorized by the SWAT Commander.

The SWAT Team consists of primary officers assigned to the SWAT Unit, and collateral officers from other assignments within the Department.

When filling vacancies in the SWAT Unit, members will be chosen from current collateral SWAT members.

When filling vacancies in the SWAT Team, members will be chosen from the current SWAT eligibility roster. Officers who have previously served on the SWAT Team are eligible to return, at the discretion of the SWAT Commander.

Personnel in an undercover assignment may not be utilized as a SWAT officer.

407.3 DEPLOYMENT

The SWAT Team is available as an additional resource for a tactical response to critical incidents at the request of Department personnel or outside law enforcement agencies. Critical incidents consist of, but are not limited to, the following:

- Barricaded or contained suspect(s) who are believed to be armed and/or dangerous.
- Hostage incidents.
- Sniper situations.
- Potentially violent persons who are believed to be armed (including mentally ill, threatened suicides, unknown circumstances, etc.)
- High risk arrest and search warrants.
- Protection operations involving high risk persons and sites.
- Any other incident where team effort or special weapons and tactics would be beneficial to the outcome of an operation.

The Department's SWAT Team and its personnel shall offer training, information, and assistance to other law enforcement agencies when requested and approved by the SWAT Commander or Tactical Commander.

407.3.1 TEAM CALL-OUT

SWAT Team response to a call-out will be in accordance with Department policy and SWAT policy. All SWAT Team pre-planned operations and call-outs will be approved in advance by the SWAT Commander or Tactical Commander.

Salt Lake City Police Department

SLCPD Policy Manual

SLCPD Policy Manual

Special Weapons and Tactics (SWAT) Team

407.3.2 DEPLOYMENT RESPONSIBILITY

Operational deployment of the SWAT team is the responsibility of the Tactical Commander. The Team Leader will coordinate all tactical deployments of the SWAT Team with the Tactical Commander, or SWAT Commander when the Tactical Commander is not available.

407.3.3 COMMAND AND CONTROL STRUCTURE OF OPERATIONS

Command of Department resources at all tactical operations rests with the Incident Commander. The Incident Commander has the authority to direct the operation and is responsible for its outcome until relieved by a superior officer.

The Tactical Commander is responsible for the management of all aspects of a tactical operation. The Tactical Commander will coordinate with the Incident Commander.

407.3.4 MULTIJURISDICTIONAL COMMAND

In the event the Department's SWAT Team responds to assist in another jurisdiction, the SWAT Commander or Tactical Commander, or authorized designee, should respond to the scene. The SWAT Team will operate under the requesting agency's Incident Commander, however, the Department's SWAT Team will take Tactical Command from the agency being assisted.

Once SWAT Team members are deployed and take charge of the incident, to include directing all personnel and equipment, there will be a formal transfer of Tactical Command to the Department's Tactical Commander.

Under no circumstances should the Department's SWAT Team be consolidated into another agency's SWAT Team tactical response unless there are clear mission boundaries pre-established (i.e., entry vs. containment). The Department's Tactical Commander may suspend this restriction in the case of extraordinarily large or complex situations.

407.3.5 USE OF FORCE

Use of force by SWAT team members will be in accordance with the Department's use of force policies and procedures.

407.3.6 PRESS RELATIONS

The Department acknowledges the public's right of access to facts surrounding matters of public interest. During tactical operations, the press will be under the purview of the Public Information Officer or Incident Commander. An area will be designated to accommodate the press; they should not be allowed into the area of operation.

In addition, the SWAT Team will:

- Refer all inquiries from the press or citizens concerning the SWAT Team to the Tactical Commander, or, if not available, the Team Leader.
- SWAT Team members shall not discuss operations, tactics, deployment, weapons, team numbers, etc. with the press unless approved by the Chief of Police or authorized designee.

Salt Lake City Police Department

SLCPD Policy Manual

SLCPD Policy Manual

Special Weapons and Tactics (SWAT) Team

407.4 SELECTION

SWAT Team selection involves an extensive testing process. All applicants must pass physical agility, weapons handling, and qualification testing to be considered for the Basic SWAT School.

The SWAT Team will select all prospective members from a valid selection roster created through applicant testing and successful completion of the Basic SWAT School.

407.5 TRAINING

All members of the SWAT Team must successfully complete the Basic SWAT School prior to an assignment as a team member. Prior to becoming operational, SWAT personnel must become and remain proficient in SWAT tactics and procedures.

The SWAT Team will conduct regular and special training as needed to gain and retain tactical skills and procedures.

All operational SWAT Team members and Team Leaders must maintain acceptable standards of performance. Failure to meet the minimum acceptable standards may result in a member being placed in a temporary, non-deployable status, until the member can achieve acceptable standards or is removed from the SWAT Team. Officers who fail to meet minimum standards will receive remedial training and will be required to successfully complete the designated training and certification as directed by the Tactical Commander.

The SWAT Team's training coordinator will track and control records pertaining to training, to include hours and proficiency.

407.6 UNIFORMS, EQUIPMENT, AND WEAPONS

407.6.1 UNIFORMS

SWAT Team personnel from this agency should wear uniforms that clearly identify team members as law enforcement officers. It is recognized that certain tactical conditions may require covert movement. Attire may be selected appropriate to the specific mission.

407.6.2 EQUIPMENT

SWAT Team personnel from this agency should be adequately equipped to meet the specific mission(s) identified by the agency.

407.6.3 WEAPONS

Weapons and equipment used by SWAT, the specialized cadres and components, and the supporting resources should be agency-issued or SWAT administration approved, including any modifications, additions or attachments.

407.6.4 MEMBERS' RESPONSIBILITY FOR EQUIPMENT

SWAT Team members are responsible for the care and maintenance of their equipment. Failure to appropriately care for or maintain equipment in full mission readiness may be grounds for removal from the SWAT Team.

Salt Lake City Police Department

SLCPD Policy Manual

SLCPD Policy Manual

Special Weapons and Tactics (SWAT) Team

407.7 CONFIDENTIALITY OF INFORMATION

All information received by members of the SWAT Team concerning operations or potential operations is considered to be confidential. The need for the safety of operational personnel is the primary consideration in dissemination of any intelligence received by SWAT personnel, and compromise of a mission must be considered.

407.8 BRIEFINGS

Operation briefing is conducted by SWAT personnel. The following personnel may attend:

- SWAT command staff and members
- Department administration
- Watch Commander
- Others personally involved in the operation

Additional personnel wanting to attend an operation briefing must obtain permission from the Tactical Commander.

All personnel attending a briefing must be identified to the SWAT Team.

At the conclusion of a briefing, no information may be released about the operation without the knowledge and consent of the Tactical Commander.

Briefings on other than pre-planned operations will be conducted with essential personnel as dictated by the situation.

407.8.1 DEBRIEFINGS

The SWAT Team will conduct a debriefing at the conclusion of an operation. Only SWAT Team members or invited personnel may attend the SWAT debrief.

407.9 MOBILIZATION OF SWAT TEAM

The on-scene supervisor shall make a request to the Watch Commander for the SWAT Team. The Watch Commander shall then notify the Tactical Commander or designee. The Watch Commander will then notify the applicable Patrol Division Commander as soon as practical.

The Watch Commander should advise the Tactical Commander with as much of the following information that is available at the time:

- (a) The number of suspects, known weapons, and resources.
- (b) If the suspect is in control of hostages.
- (c) If the suspect is barricaded.
- (d) The type of crime involved.
- (e) If the suspect has threatened or attempted suicide.
- (f) The location of the command post and a safe approach to it.
- (g) The extent of any perimeter and the number of officers involved.

Salt Lake City Police Department

SLCPD Policy Manual

SLCPD Policy Manual

Special Weapons and Tactics (SWAT) Team

- (h) Any other important facts critical to the immediate situation and whether the suspect has refused an order to surrender.

The Tactical Commander and Watch Commander will then determine an appropriate response.

407.9.1 FIELD UNIT RESPONSIBILITIES

While waiting for the SWAT Team, field personnel should, if safe and practicable, and sufficient resources exist:

- (a) Establish an inner and outer perimeter.
- (b) Establish a command post outside of the inner perimeter.
- (c) Establish an arrest/emergency action team. The team actions may include:
 - 1. Securing any subject or suspect who may surrender.
 - 2. Taking action to mitigate a deadly threat or behavior.
- (d) Evacuate any injured persons or citizens in the zone of danger.
- (e) Attempt to establish preliminary communication with the suspect. Once the SWAT Team has arrived, all negotiations should generally be halted to allow the negotiators and SWAT Team time to set up.
- (f) Be prepared to brief the Tactical Commander on the situation.
- (g) Plan for, and stage, anticipated resources.

407.10 REVISIONS

Enacted: March 26, 2018

Response to Bomb Calls

408.1 PURPOSE AND SCOPE

The purpose of this policy is to provide guidelines to assist members of the Salt Lake City Police Department in their initial response to incidents involving explosives, explosive devices, suspicious packages, explosion/bombing incidents, or threats of such incidents. Under no circumstances should these guidelines be interpreted as compromising the safety of first responders or the public. When confronted with an incident involving explosives, safety should always be the primary consideration.

408.2 POLICY

It is the policy of the Salt Lake City Police Department to place a higher priority on the safety of persons and the public over damage or destruction to public or private property.

408.3 RECEIPT OF BOMB THREAT

Department members receiving a bomb threat should obtain as much information from the individual as reasonably possible, including the type, placement, alleged detonation time of the device(s), organization or cause the individual identifies with, and if applicable the specific target(s).

If the bomb threat is received on a recorded line, reasonable steps should be taken to ensure that the recording is preserved in accordance with established department evidence procedures.

The member receiving the bomb threat should ensure that the Watch Commander is immediately advised and informed of the details. This will enable the Watch Commander to ensure that the appropriate personnel are dispatched and, as appropriate, the threatened location is given an advance warning.

Responding officers, working at the direction of the field sergeant, will respond to the location, contact responsible parties, collect information, provide advice, and secure the scene.

408.4 GOVERNMENT FACILITY OR PROPERTY

A bomb threat targeting a government facility may require a different response based on the government agency.

408.4.1 SALT LAKE CITY POLICE DEPARTMENT FACILITY

If the bomb threat is against a Salt Lake City Police Department facility, the Watch Commander will direct and assign officers as required for coordinating a general building search or evacuation of the police department, as he/she deems appropriate.

408.4.2 OTHER COUNTY OR MUNICIPAL FACILITY OR PROPERTY

If the bomb threat is against a county or municipal facility within the jurisdiction of the Salt Lake City Police Department that is not the property of this department, the appropriate agency will be promptly informed of the threat. Assistance to the other entity may be provided as the Watch Commander deems appropriate.

Salt Lake City Police Department

SLCPD Policy Manual

SLCPD Policy Manual

Response to Bomb Calls

408.4.3 FEDERAL BUILDING OR PROPERTY

If the bomb threat is against a federal building or property, the Federal Protective Service should be immediately notified. The Federal Protective Service provides a uniformed law enforcement response for most facilities, which may include use of its Explosive Detector Dog teams.

If the bomb threat is against a federal government property where the Federal Protective Service is unable to provide a timely response, the appropriate facility's security or command staff should be notified.

Bomb threats against a military installation should be reported to the military police or other military security responsible for the installation.

408.5 PRIVATE FACILITY OR PROPERTY

When a member of this department receives notification of a bomb threat at a location in the City of Salt Lake City, the member receiving the notification should obtain as much information as reasonably possible from the notifying individual, including:

- (a) The location of the facility.
- (b) The nature of the threat.
- (c) Whether the type and detonation time of the device is known.
- (d) Whether the facility is occupied and, if so, the number of occupants currently on-scene.
- (e) Whether the individual is requesting police assistance at the facility.
- (f) Whether there are any internal facility procedures regarding bomb threats in place, such as:
 - 1. No evacuation of personnel and no search for a device.
 - 2. Search for a device without evacuation of personnel.
 - 3. Evacuation of personnel without a search for a device.
 - 4. Evacuation of personnel and a search for a device.

The member receiving the bomb threat information should ensure that the Watch Commander is immediately notified.

408.5.1 ASSISTANCE

Unless an actual or suspected explosive device is found, the decision to evacuate, search, or take no action at all rests with the responsible party of the victim location. Responding police personnel will only advise the management concerning safety, and assist in evacuation if requested. If such assistance is requested, the Watch Commander shall be notified. The Watch Commander will make the decision whether the Department will render assistance and at what level.

Should the Watch Commander determine that the Department will assist, he/she will determine:

- (a) The appropriate level of assistance.
- (b) The plan for assistance.

Salt Lake City Police Department

SLCPD Policy Manual

SLCPD Policy Manual

Response to Bomb Calls

- (c) The need for additional resources.

408.6 FOUND DEVICE

When handling an incident involving a suspected explosive device, the following guidelines, while not all inclusive, should be followed:

- (a) No known or suspected explosive item should be considered safe regardless of its size or apparent packaging.
- (b) The device should not be touched or moved except by the Hazardous Device Unit (HDU) or military explosive ordnance disposal team.
- (c) Personnel should not transmit on any equipment that is capable of producing radio frequency energy within the immediate vicinity around the suspected device. This includes the following:
 - 1. Two-way radios
 - 2. Cell phones
 - 3. Other personal communication devices
- (d) The appropriate HDU or military explosive ordnance disposal team should be summoned for assistance at the determination of the Watch Commander.
- (e) Three hundred (300) feet or the largest perimeter reasonably possible should initially be established around the device based upon available personnel and the anticipated danger zone.
- (f) A safe access route should be provided for support personnel and equipment.
- (g) Search the area for secondary devices as appropriate and based upon available resources.
- (h) Consider evacuation of buildings and personnel near the device or inside the danger zone and the safest exit route.
- (i) Promptly relay available information to the Watch Commander including:
 - (a) The time of discovery.
 - (b) The exact location of the device.
 - (c) A full description of the device (e.g., size, shape, markings, construction).
 - (d) The anticipated danger zone and perimeter.
 - (e) The areas to be evacuated or cleared.

If an explosive device or suspected explosive device is located, the HDU will determine the rendering safe procedures. HDU will inform the Watch Commander, who will inform the responsible party of the victim location. If the responsible party disagrees with HDU's suggested procedures, the Watch Commander may decide to exercise police control over the victim facility based on information and circumstances that indicate a reasonably apparent and imminent threat to the safety of either the facility or the public.

Salt Lake City Police Department

SLCPD Policy Manual

SLCPD Policy Manual

Response to Bomb Calls

408.7 EXPLOSION/BOMBING INCIDENTS

When an explosion has occurred, there are multitudes of considerations which may confront the responding officers. As in other catastrophic events, a rapid response may help to minimize injury to victims, minimize contamination of the scene by gathering crowds, or minimize any additional damage from fires or unstable structures.

408.7.1 CONSIDERATIONS

Officers responding to explosions, whether accidental or a criminal act, should consider the following actions:

- (a) Assess the scope of the incident, including the number of victims and extent of injuries.
- (b) Request additional personnel and resources, as appropriate.
- (c) Assist with first aid.
- (d) Identify and take appropriate precautions to mitigate scene hazards, such as collapsed structures, blood borne pathogens and hazardous materials.
- (e) Assist with the safe evacuation of victims, if possible.
- (f) Establish an inner perimeter to include entry points and evacuation routes. Search for additional or secondary devices.
- (g) Preserve evidence.
- (h) Establish an outer perimeter and evacuate if necessary.
- (i) Identify witnesses.

408.7.2 NOTIFICATIONS

When an explosion has occurred, the following people should be notified as appropriate:

- Fire department
- HDU
- Additional department personnel, such as investigators and forensic services
- Field supervisor
- Watch Commander
- Other law enforcement agencies, including local, state or federal agencies, such as the FBI and the Bureau of Alcohol, Tobacco, Firearms and Explosives (ATF)
- Gas, Electric, and other Utility companies
- Other government agencies, as appropriate

408.7.3 CROWD CONTROL

Only authorized members with a legitimate need should be permitted access to the scene. Spectators and other unauthorized individuals should be restricted to a safe distance as is reasonably practicable given the available resources and personnel.

Salt Lake City Police Department

SLCPD Policy Manual

SLCPD Policy Manual

Response to Bomb Calls

408.7.4 PRESERVATION OF EVIDENCE

As in any other crime scene, steps should immediately be taken to preserve the scene. The Watch Commander should assign officers to protect the crime scene area, which could extend over a long distance. Consideration should be given to the fact that evidence may be imbedded in nearby structures or hanging in trees and bushes. Officers and crime lab personnel on scene will be responsible for the collection of evidence at the discretion of HDU personnel.

408.8 REVISIONS

Enacted: March 26, 2018

Civil Commitments

409.1 PURPOSE AND SCOPE

This policy provides guidelines for when officers may place an individual under protective custody for a civil commitment.

409.2 POLICY

It is the policy of the Salt Lake City Police Department to protect the public and individuals through legal and appropriate use of the civil commitment process.

409.2.1 TYPES OF CIVIL COMMITMENT

- (a) Emergency Application for Involuntary Commitment Without Certification (commonly referred to as a "Pink Sheet") - A civil commitment form used by a mental health officer or peace officer to involuntarily commit an individual when specific requirements are met.
- (b) Emergency Application for Involuntary Commitment With Certification (commonly referred to as a "Blue Sheet") - A civil commitment form used by a medical doctor or designated examiner.
- (c) Application for Order of Involuntary Commitment (commonly referred to as a "White Sheet") - A civil commitment form used by the courts and issued by a judge.

409.3 AUTHORITY

If an officer observes a person involved in conduct that gives the officer probable cause to believe that the person is mentally ill, and because of that mental illness, there is a substantial likelihood of serious harm to that person or others, the officer may take that person into protective custody (Utah Code 62A-15-629(2)).

The officer shall ensure transport of the person to a designated facility of the appropriate local mental health authority, either on the basis of his/her own observation or on the basis of a mental health officer's observation reported to him/her by the mental health officer. The officer shall place the person in the custody of the local mental health authority and make application for commitment by completing an Emergency Application for Involuntary Commitment Without Certification (Pink Sheet).

If assistance is requested by proper authorities (a physician should have a wallet size reproduction of their state license, and a designated examiner or mental health officer will have identification cards identifying them as such) in facilitation of a civil commitment (Pink Sheet, Blue Sheet, or White Sheet), officers shall assist upon verification of the proper form(s).

Notwithstanding the above, state law allows peace officers to exercise discretion and not take an individual into custody or transport an individual for involuntary temporary commitment when an officer has probable cause to believe, based on the officer's experience and applicable training, that taking an individual into protective custody or transporting an individual for temporary commitment would increase the risk of substantial danger to the individual or others (Utah Code

Salt Lake City Police Department

SLCPD Policy Manual

SLCPD Policy Manual

Civil Commitments

62A-15-629(5)(b)). This is the exception rather than the rule, and requires supervisor approval (the decision, and the justifications behind it, shall be documented in an initial report). Moreover, if an individual is reasonably deemed a danger to others and probable cause has been met for an involuntary commitment, officers shall take that individual into custody for involuntary commitment.

409.3.1 VOLUNTARY EVALUATION

If an officer encounters an individual who may qualify for a civil commitment, he/she may inquire as to whether the person desires to voluntarily be evaluated at an appropriate facility. If the individual so desires, the officers should:

- (a) Ensure transportation of the individual to an appropriate facility that is able to conduct the evaluation.
- (b) If at any point the individual changes his/her mind regarding voluntary evaluation, officers should proceed with the civil commitment, if appropriate.
- (c) Document the circumstances surrounding the individual's desire to pursue voluntary evaluation and/or admission.

409.3.2 CIVIL COMMITMENT OF JUVENILES

Civil commitment procedures for persons under 18 years of age are the same as civil commitment procedures for adults except for the following:

- (a) If a juvenile's parent/legal guardian believes the juvenile requires emergency psychological care, or if a juvenile meets the criteria for civil commitment and a parent/legal guardian is present, the parent/legal guardian can give permission for the civil commitment. Officers are not required to complete the Pink Sheet procedure. Officers may assist with the coordination of transportation as needed.
- (b) If the officer decides to complete the Pink Sheet procedure in agreement with the parent/legal guardian, the juvenile may be transported by the parent/legal guardian at the officer's discretion.
- (c) If a parent/legal guardian is not present, or the officer is in disagreement with the decision of the parent/legal guardian not to civilly commit the juvenile, the officer may have the juvenile transported to a hospital and complete the Pink Sheet procedure (Utah Code 62A.15.703(6)). A duly authorized peace officer can temporarily commit a child who is demonstrating behavior that is considered to be a danger to themselves or others without permission from a parent or guardian. It is the responsibility of the officer to attempt to make contact with the parent/legal guardian of the juvenile prior to the transport. If the parent/legal guardian cannot be reached the officer must call DCFS to report the situation. The officer shall document the attempt(s) to contact the parent/legal guardian in their report.
- (d) Civil commitment of juveniles should be completed at Primary Children's Medical Center (PCMC) unless a medical emergency requires care at the nearest hospital.

409.4 CONSIDERATIONS AND RESPONSIBILITIES

Any officer handling a call involving an individual who may qualify for a civil commitment should consider, as time and circumstances reasonably permit:

Salt Lake City Police Department

SLCPD Policy Manual

SLCPD Policy Manual

Civil Commitments

- (a) Available information that might assist in determining the cause and nature of the individual's action or stated intentions.
- (b) The use of outreach services, such as the University of Utah's Mobile Crisis Outreach Team (MCOT).
- (c) Conflict resolution and de-escalation techniques.

While these steps are encouraged, nothing in this section is intended to dissuade officers from taking reasonable action to ensure the safety of the officers and others.

Civil commitments should be preferred over arrest for people with mental health issues, who are suspected of committing minor crimes or creating other public safety issues.

409.5 TRANSPORTATION

Officers shall contact medical to evaluate the individual to verify there are no immediate medical needs. If the subject is cleared medically, and the situation permits, officers may transport subjects to the hospital in their patrol vehicle. Officers may transport an individual to Salt Lake Regional Hospital, University of Utah Hospital, LDS Hospital, Primary Children's Hospital, or the VA Hospital (for qualified veterans). While officers may take the individual's request for which hospital to be transported into consideration, the final decision rests with the officer.

When transporting any individual for a civil commitment, to include voluntary transports, the transporting officer shall contact the on-duty charge nurse or house supervisor to notify the receiving facility of the patient's details, estimated time of arrival, the level of cooperation of the individual and whether any special medical care is needed.

If officers transport individuals in a patrol vehicle, officers shall secure them in accordance with the Handcuffing and Restraints Policy. Officers may ride in an ambulance should the detainee require transport in a medical transport vehicle and the safety of any person, including the detainee, requires the presence of an officer during the transport.

Direct Numbers:

Salt Lake Regional Hospital 801-350-4631

University of Utah Hospital 801-585-5000

LDS Hospital 801-408-1180

Primary Children's Hospital 801-662-1281

VA Hospital 801-584-1205

409.6 TRANSFER TO APPROPRIATE FACILITY

Upon arrival at the facility, the officer will escort the individual into a treatment area designated by a facility staff member. If the individual is not seeking treatment voluntarily, the officer should provide the staff member with the written Emergency Application for Involuntary Commitment Without Certification and remain present to provide clarification of the grounds for detention, upon request.

Salt Lake City Police Department

SLCPD Policy Manual

SLCPD Policy Manual

Civil Commitments

Absent exigent circumstances, the transporting officer should not assist facility staff with the admission process, including restraint of the individual. However, if the individual is transported and delivered while restrained, the officer may assist with transferring the individual to facility restraints and will be available to assist during the admission process, if requested. Under normal circumstances, officers will not apply facility-ordered restraints.

409.7 DOCUMENTATION

The officer shall complete an application for commitment and provide it to the facility staff member assigned to the individual. The officer will retain a copy of the application and submit it to records before the end of their shift to be scanned into the case.

The officer shall also complete a General Offense report, in accordance with the Report Preparation Policy, utilizing the NCIC code of 5399-23.

409.8 CRIMINAL OFFENSES

Officers investigating an individual who is suspected of committing a minor criminal offense and who is being taken for a civil mental commitment should resolve the criminal matter by issuing a warning or a citation, as appropriate.

When an individual who may qualify for a civil commitment has committed a serious criminal offense that would normally result in an arrest and transfer to a jail facility, the officer should:

- (a) Arrest the individual when there is probable cause to do so.
- (b) Notify the appropriate supervisor of the facts supporting the arrest and the facts that would support the civil commitment.
- (c) Facilitate the individual's transfer to the jail facility and advise the jail of the mental health conditions of the subject.
- (d) Thoroughly document in the related reports the circumstances that indicate the individual may qualify for a civil commitment.

409.9 FIREARMS AND OTHER WEAPONS

Officers should consider whether it is appropriate and consistent with current search and seizure law under the circumstances to seize any such firearms or other dangerous weapons (e.g. safekeeping, evidence, consent).

Officers are cautioned that a search warrant may be needed before entering a residence or other place to search, unless lawful, warrantless entry has already been made (e.g., exigent circumstances, consent). A warrant may also be needed before searching for or seizing weapons.

If an officer seizes a weapon with concern the weapon will be used by a mentally ill subject to harm themselves or another, the weapon shall be placed into evidence as seized property and not as safekeeping. The officer will notify the owner of such seizure and document this notification in their report.

The handling officers should further advise the individual of the procedure for the return of any firearm or other weapon that has been taken into custody.

Salt Lake City Police Department

SLCPD Policy Manual

SLCPD Policy Manual

Civil Commitments

409.10 TRAINING

This department will endeavor to provide on-going training on interaction with mentally disabled persons, civil commitments and crisis intervention. Refer to the Crisis Intervention Incidents Policy for additional details.

409.11 REVISIONS

Enacted: March 26, 2018

Revised: July 2, 2018

Revised: June 13, 2019

Citation Releases

410.1 PURPOSE AND SCOPE

The purpose of this policy is to provide members of the Salt Lake City Police Department with guidance on when to release adults who are suspected offenders on a citation for a criminal offense, rather than having the person held in custody for a court appearance or released on bail.

Additional release restrictions may apply to those detained for domestic violence, as outlined in the Domestic Violence Policy.

410.2 POLICY

The Salt Lake City Police Department will consider its resources and its mission of protecting the community when exercising any discretion to release suspected offenders on a citation, when authorized to do so. Whenever possible, officers will use a misdemeanor citation in lieu of a custodial arrest.

It is departmental policy to issue a citation to all persons charged with a misdemeanor or infraction unless there is a positive reason to make a custodial arrest. If the person is under 18 years of age, juvenile rules apply (see the Temporary Custody of Juveniles Policy and associated Procedure for details).

While not a custodial arrest, issuance of a citation does constitute an arrest. It is an order to appear before a magistrate on the arrested person's own volition.

410.3 RELEASE

A suspected offender may be released on issuance of a citation as follows:

- (a) When the person is arrested for a misdemeanor B, C, or infraction charge (Utah Code 77-7-18).
- (b) When a warrant has been issued by a magistrate who has included in the order that the person be released on a summons (U. R. Crim. P. Rule 6).

410.4 PROHIBITIONS

Offenses and conditions ineligible for misdemeanor citations:

- (a) If the offense is a class A misdemeanor or felony.
- (b) The arrested person is wanted in another jurisdiction and that jurisdiction will extradite.
- (c) The officer reasonably believes that the person will, if released on a citation rather than being booked into jail, constitute a danger to himself or others.
- (d) The arrested person cannot be identified to the arresting officer's satisfaction.
- (e) The arrested person is not a resident of the state of Utah or the officer reasonably believes the person will not appear to answer charges against that person.
- (f) The release of a suspected offender on a citation is not permitted if prohibited by local court rule.

Salt Lake City Police Department

SLCPD Policy Manual

SLCPD Policy Manual

Citation Releases

- (g) See the Domestic Violence Policy for release restrictions related to those investigations.

410.5 CONSIDERATIONS

In determining whether to cite and release a person when discretion is permitted, officers should consider:

- (a) The type of offense committed.
- (b) The known criminal history of the suspected offender.
- (c) The ability to identify the suspected offender with reasonable certainty.
- (d) Whether there is any record of the individual failing to appear in previous cases or other articulable indications that the individual may not appear in court for this offense.
- (e) The individual's ties to the area, such as residence, employment or family.
- (f) Whether there is reasonable likelihood that criminal conduct by the individual will continue.

410.6 STATE PRIVILEGES

410.6.1 LEGISLATIVE PRIVILEGE

Members of the Legislature shall not be subject to arrest during each general and special session of the Legislature or for 15 days immediately preceding and following each session, except for any felony, treason or breach of the peace. Legislators may be issued a citation and a summons to appear at a date outside of the time of legislative privilege (Utah Constitution Article VI § 8).

410.6.2 NATIONAL GUARD PRIVILEGE

Members of the National Guard shall not be subject to citation or arrest during military exercises or other duty when emergency circumstances require the member's presence, except for an act of treason, a class A misdemeanor or felony, breach of the peace, reckless driving or driving under the influence (DUI) (Utah Code 39-1-54).

410.6.3 VOTER PRIVILEGE

A person who attends an election or who is traveling to and from a voting location shall not be subject to arrest on an election day, except for an act of treason, a felony or a breach of the peace (Utah Constitution Article IV § 3).

410.7 REVISIONS

Enacted: March 26, 2018

Revised: December 17, 2018

Arrest or Detention of Foreign Nationals

411.1 PURPOSE AND SCOPE

This policy provides guidelines to ensure that members of the Salt Lake City Police Department extend appropriate privileges and immunities to foreign diplomatic and consular representatives in accordance with international law.

411.2 POLICY

The Salt Lake City Police Department respects international laws related to the special privileges and immunities afforded foreign diplomatic and consular representatives assigned to the United States.

All foreign diplomatic and consular representatives shall be treated with respect and courtesy, regardless of any privileges or immunities afforded them.

411.3 CLAIMS OF IMMUNITY

If a member comes into contact with a person where law enforcement action may be warranted and the person claims diplomatic or consular privileges and immunities, the member should, without delay:

- (a) Notify a supervisor.
- (b) Advise the person that his/her claim will be investigated and he/she may be released in accordance with the law upon confirmation of the person's status.
- (c) Request the person's identification card, either issued by the U.S. Department of State (DOS), Office of the Chief of Protocol, or in the case of persons accredited to the United Nations, by the U.S. Mission to the United Nations. These are the only reliable documents for purposes of determining privileges and immunities.
- (d) Contact the DOS Diplomatic Security Command Center at 571-345-3146 or toll free at 866-217-2089, or at another current telephone number and inform the center of the circumstances.
- (e) Verify the immunity status with DOS and follow any instructions regarding further detention, arrest, prosecution and/or release, as indicated by the DOS representative. This may require immediate release, even if a crime has been committed.

Identity or immunity status should not be presumed from the type of license plates displayed on a vehicle. If there is a question as to the status or the legitimate possession of a Diplomat or Consul license plate, a query should be run via the National Law Enforcement Telecommunications System (NLETS), designating "US" as the state.

411.4 ENFORCEMENT ACTION

If the DOS is not immediately available for consultation regarding law enforcement action, members shall be aware of the following:

Salt Lake City Police Department

SLCPD Policy Manual

SLCPD Policy Manual

Arrest or Detention of Foreign Nationals

- (a) Generally, all persons with diplomatic and consular privileges and immunities may be issued a citation or notice to appear. However, the person may not be compelled to sign the citation.
- (b) All persons, even those with a valid privilege or immunity, may be reasonably restrained in exigent circumstances for purposes of self-defense, public safety or the prevention of serious criminal acts.
- (c) An impaired foreign diplomatic or consular representative may be prevented from driving a vehicle, even if the person may not be arrested due to privileges and immunities.
 - 1. Investigations, including the request for field sobriety tests, chemical tests and any other tests regarding impaired driving may proceed but they shall not be compelled.
- (d) The following persons may not be detained or arrested, and any property or vehicle owned by these persons may not be searched or seized:
 - 1. Diplomatic-level staff of missions to international organizations and recognized family members
 - 2. Diplomatic agents and recognized family members
 - 3. Members of administrative and technical staff of a diplomatic mission and recognized family members
 - 4. Career consular officers, unless the person is the subject of a felony warrant
- (e) The following persons may generally be detained and arrested:
 - 1. International organization staff; however, some senior officers are entitled to the same treatment as diplomatic agents.
 - 2. Support staff of missions to international organizations
 - 3. Diplomatic service staff and consular employees; however, special bilateral agreements may exclude employees of certain foreign countries
 - 4. Honorary consular officers

411.5 DOCUMENTATION

All contacts with persons who have claimed privileges and immunities afforded foreign diplomatic and consular representatives should be thoroughly documented and the related reports forwarded to DOS.

411.5.1 DOCUMENTATION PROCEDURES

An officer who stops a person holding a driver's license issued by the DOS or otherwise claiming privileges or immunities, for a moving traffic violation or any of the following offenses while operating a vehicle shall document all of the relevant information from the driver license or identification card (Utah Code 41-6a-1901):

- (a) Automobile homicide
- (b) Manslaughter

Salt Lake City Police Department

SLCPD Policy Manual

SLCPD Policy Manual

Arrest or Detention of Foreign Nationals

- (c) Negligent homicide
- (d) Aggravated assault
- (e) Reckless endangerment

The Records Section shall forward such information with a copy of the traffic citation, vehicle accident report or written report of the incident, as applicable, to the Department of Public Safety (DPS) within five working days (Utah Code 41-6a-1901).

411.6 REVISIONS

Enacted: March 26, 2018

Rapid Response and Deployment

412.1 PURPOSE AND SCOPE

Violence that is committed in schools, workplaces and other locations by individuals or a group of individuals who are determined to target and kill persons and to create a high number of casualties presents a difficult situation for law enforcement. The purpose of this policy is to identify guidelines and factors that will assist responding officers in situations that call for rapid response and deployment.

412.2 POLICY

The Salt Lake City Police Department will endeavor to plan for rapid response to crisis situations, and to coordinate response planning with other emergency services.

Nothing in this policy shall preclude the use of reasonable force, deadly or otherwise, by members of the Department in protecting themselves or others from death or serious injury.

During a rapid response and deployment situation, exceptions to uniform policy are made to allow for the use of additional body armor and tactical equipment deemed appropriate for dealing with killing-in-progress.

412.3 CONSIDERATIONS

The following list generally describes the first responder's function in a rapid response and deployment situation. This list is not intended to be all-inclusive, is not necessarily in order, and may be altered according to the demands of each situation:

- (a) Implement the seven critical tasks for incident stabilization:
 1. Establish communications and control - the first arriving officer should assess the immediate situation and take reasonable steps to maintain operative control of the incident until relieved by a supervisor or incident commander.
 2. Identify the hot zone.
 3. Establish the inner perimeter to contain and isolate the incident.
 4. Establish the outer perimeter, as time and resources allow, to control pedestrian and vehicular traffic into the area.
 5. Establish a unified command post.
 6. Establish a staging area.
 7. Request resources.
- (b) Gather intelligence on the circumstances, location, and suspect(s) involved in the incident.
- (c) Attempt to attain a tactical advantage over the suspect.
- (d) Form an emergency action team (EAT) if necessary.
- (e) Determine if there are any injuries.

Salt Lake City Police Department

SLCPD Policy Manual

SLCPD Policy Manual

Rapid Response and Deployment

- (f) Determine what types of weapons are involved.
- (g) Evaluate whether to evacuate occupants of affected residences and businesses to a point beyond the outer perimeter or have them shelter in place.
- (h) Develop a surrender plan. If feasible, communicate this plan to the suspect(s), attempting to negotiate release of hostages and surrender of the suspect(s).
- (i) If the situation requires additional police personnel, mutual aid requests should be made in accordance with the Outside Agency Assistance Policy.

Officers are encouraged to keep in mind the proper use of cover and concealment while carrying out their assignments in these situations.

412.4 FIRST RESPONSE

If there is a reasonable belief that acts or threats by a suspect are placing lives in imminent danger, first responding officers should consider reasonable options to reduce, prevent or eliminate the threat. Officers must decide, often under a multitude of difficult and rapidly evolving circumstances, whether to advance on the suspect, take other actions to deal with the threat, or wait for additional resources.

If a suspect is actively engaged in the infliction of serious bodily harm or other life-threatening activity toward others, officers should take immediate action, if reasonably practicable, while requesting additional assistance.

Officers should remain aware of the possibility that an incident may be part of a coordinated multi-location attack that may require some capacity to respond to other incidents at other locations.

When deciding on a course of action officers should consider:

- (a) Whether to advance on or engage a suspect who is still a possible or perceived threat to others. Any advance or engagement should be based on information known or received at the time.
- (b) Whether to wait for additional resources or personnel. This does not preclude an individual officer from taking immediate action.
- (c) Whether individuals who are under imminent threat can be moved out of danger or evacuated with reasonable safety.
- (d) Whether the suspect can be contained or denied access to victims.
- (e) Whether the officers have the ability to effectively communicate with other personnel or resources.
- (f) Whether planned tactics can be effectively deployed.
- (g) The availability of rifles, shotguns, shields, breaching tools, control devices and any other appropriate tools, and whether the deployment of these tools will provide a tactical advantage.

Salt Lake City Police Department

SLCPD Policy Manual

SLCPD Policy Manual

Rapid Response and Deployment

In the absence of hostages, and with no immediate threat to others, officers should follow barricade policy and procedure (see the Hostage and Barricade Incidents Policy and associated Procedure).

[Salt Lake City Police Department Policy Manual: 406.4.1 BARRICADE SITUATION](#)

412.5 PUBLIC NOTIFICATION

During the initial phases of a rapid response and deployment incident, the Public Information Officer (PIO) will work with the Incident Commander, Dispatch, and the media to notify the public of the threat as soon as practicable to prevent further casualties and to inform the public where they may obtain additional information. In the event the PIO is not readily available, the Incident Commander or designee will be responsible for making these notifications as soon as practicable.

Notification may include, but is not limited to, traditional media outlets, social media, and/or emergency broadcast systems.

412.6 TRAINING AND REVIEW

It is the responsibility of the Training Lieutenant to ensure that all sworn employees of the Department receive training on the response to active threats/rapid response and deployment incidents.

An annual review of this policy will be conducted by the Operations Bureau Commander, or their designee, and any training needs will be identified and implemented as needed.

412.7 REVISIONS

Enacted: March 26, 2018

Revised: May 21, 2018

Immigration Violations

413.1 PURPOSE AND SCOPE

The purpose of this policy is to provide guidelines to members of the Salt Lake City Police Department regarding immigration laws.

413.2 POLICY

It is the policy of the Salt Lake City Police Department that all members make personal and professional commitments to equal enforcement of the law and equal service to the public. Confidence in this commitment will increase the effectiveness of this department in protecting and serving the entire community and recognizing the dignity of all persons, regardless of their immigration status.

413.3 VICTIMS AND WITNESSES

To encourage crime reporting and cooperation in the investigation of criminal activity, all individuals, regardless of their immigration status, must feel secure that contacting or being addressed by members of law enforcement will not automatically lead to immigration inquiry and/or deportation. While it may be necessary to determine the identity of a victim or witness, members shall treat all individuals equally and without regard to race, color or national origin in any way that would violate the United States or Utah Constitutions.

413.4 IMMIGRATION HOLDS

No individual should be held based solely on a federal immigration detainer under 8 CFR 287.7 unless the person has been charged with a federal crime or the detainer is accompanied by a warrant, affidavit of probable cause, or removal order. Notification to the federal authority issuing the detainer should be made prior to the release.

413.5 ARREST NOTIFICATION TO IMMIGRATION AND CUSTOMS ENFORCEMENT (ICE)

Generally, an officer will not need to notify ICE when booking arrestees at the county jail. Immigration officials routinely interview suspected undocumented aliens who are booked into the county jail on criminal charges. Notification will be handled according to jail operation procedures. No individual who is otherwise ready to be released should continue to be detained solely for the purpose of notification.

413.6 ICE REQUEST FOR ASSISTANCE

Requests by ICE, or any other federal agency, for assistance from this department should be directed to a supervisor. The Department may provide available support services, such as traffic control or peacekeeping efforts, to ICE or other federal agencies.

413.7 INFORMATION SHARING

No member of this department will prohibit, or in any way restrict, any other member from doing any of the following regarding the citizenship or immigration status, lawful or unlawful, of any individual (8 USC § 1373):

Salt Lake City Police Department

SLCPD Policy Manual

SLCPD Policy Manual

Immigration Violations

- (a) Sending information to, or requesting or receiving such information from ICE
- (b) Maintaining such information in department records
- (c) Exchanging such information with any other federal, state or local government entity

413.8 U VISA AND T VISA NON-IMMIGRANT STATUS

Under certain circumstances, federal law allows temporary immigration benefits, known as a U visa, to victims and witnesses of certain qualifying crimes (8 USC § 1101(a)(15)(U)). A law enforcement certification for a U visa may be completed by an officer in order for a U visa to be issued.

Similar immigration protection, known as a T visa, is available for certain qualifying victims of human trafficking (8 USC § 1101(a)(15)(T)). A law enforcement declaration for a T visa may be completed by an officer in order for a T visa to be issued.

Any request for assistance in applying for U visa or T visa status should be forwarded in a timely manner to the Investigations Division Persons Crime Lieutenant. The Investigations Division Persons Crime Lieutenant or designee should:

- (a) Consult with the assigned investigator to determine the current status of any related case and whether further documentation is warranted (this may be accomplished by examining applicable reports).
- (b) Contact the appropriate prosecutor assigned to the case, if applicable, to ensure the certification or declaration has not already been completed and whether a certification or declaration is warranted.
- (c) Address the request and complete the certification or declaration, if appropriate, in a timely manner.
 - i. The instructions for completing certification and declaration forms can be found on the U.S. Department of Homeland Security (DHS) website.

413.9 REVISIONS

Enacted: March 26, 2018

Revised: May 21, 2018

Emergency Utility Service

414.1 PURPOSE AND SCOPE

The City Public Utilities department has personnel available to handle emergency calls 24 hours per day. Calls for service during non-business hours are frequently directed to the Department. Requests for such service received by this department should be handled in the following manner.

414.1.1 BROKEN WATER LINES

The City's responsibility ends at the water meter; any break or malfunction in the water system from the water meter to the citizen's residence or business is the customer's responsibility. Public Utilities can only turn off the valve at the meter. The citizen can normally accomplish this.

If a break occurs on the City side of the meter, emergency personnel should be called as soon as practical by Dispatch.

414.1.2 ELECTRICAL LINES

City Public Utilities does not maintain electrical lines to street light poles. When a power line poses a hazard, an officer should be dispatched to protect against personal injury or property damage that might be caused by power lines. The electric company or Public Utilities should be promptly notified, as appropriate.

414.1.3 RESERVOIRS, PUMPS, WELLS

Public Utilities maintains the reservoirs and public water equipment, as well as several underpass and other street drainage pumps. In the event of flooding or equipment malfunctions, emergency personnel should be contacted as soon as possible.

414.1.4 EMERGENCY NUMBERS

A current list of emergency personnel who are to be called for municipal utility emergencies is maintained by Dispatch.

414.2 TRAFFIC SIGNALS

Upon observing a damaged or malfunctioning signal, or there is a need for manual operation of traffic signals, the officer will advise Dispatch of the location and issue. The dispatcher should make the necessary notification to the proper department or agency.

414.3 REVISIONS

Enacted: March 26, 2018

Field Training Officer Program

415.1 PURPOSE AND SCOPE

The Field Training Program is intended to provide a standardized program to facilitate the officer's transition from the academic setting to the actual performance of general law enforcement duties of the Salt Lake City Police Department.

It is the policy of the Department to assign all new police officers to a structured Field Training Program that is designed to prepare the new officer to perform in a patrol assignment, and possessing all skills needed to operate in a safe, productive and professional manner.

415.2 FIELD TRAINING OFFICER SELECTION AND TRAINING

A Field Training Officer (FTO) is responsible for training and mentoring recruit officers and will continue the training the recruit received during the Police Academy. The FTO must be effective in teaching and communicating and will be required to objectively evaluate a recruit's daily performance, establish weekly training objectives, and work effectively as a member of each recruit's training team. The FTO will make a recommendation to the Program Coordinator as to whether or not the recruit has met the standards of the program and can perform the required duties of a police officer. FTOs receive two hours of overtime pay for every full shift spent training a recruit in the FTO program.

415.2.1 SELECTION PROCESS

FTOs will be selected based upon multiple requirements determined by Patrol Division Administration at the time vacancies are announced. At a minimum, successful candidates shall be:

- (a) Off probation
- (b) Working in Patrol, or in a Patrol-support assignment (e.g., Bikes, Motors, etc.)

415.2.2 TRAINING

An officer selected as a Field Training Officer shall successfully complete Salt Lake City Police Department's two-day FTO School.

Officers in the FTO program will be required to attend annual recertification training to remain current as an FTO. Officers who do not work in Patrol or in a Patrol-support position may maintain certification, but will not be utilized in the program.

415.3 FIELD TRAINING OFFICER PROGRAM SUPERVISOR

The Field Training Officer Program supervisor will be selected from the rank of sergeant or above by a Patrol Division Commander or designee.

The responsibilities of the FTO Program Supervisor include the following:

- (a) Assignment of trainees to FTOs.
- (b) Conduct FTO meetings.

Salt Lake City Police Department

SLCPD Policy Manual

SLCPD Policy Manual

Field Training Officer Program

- (c) Maintain and ensure FTO/Trainee performance evaluations are completed.
- (d) Maintain, update, and issue the Field Training Manual to each trainee.
- (e) Monitor individual FTO performance.
- (f) Monitor overall FTO Program.
- (g) Maintain liaison with academy staff on recruit performance during the academy.
- (h) Develop ongoing training for FTOs.

415.4 TRAINEE DEFINED

Any entry level or lateral police officer newly appointed to the Salt Lake City Police Department who has successfully completed a POST-approved Basic Academy.

415.5 REQUIRED TRAINING

Entry level officers shall be required to successfully complete, at a minimum, a 16-week Field Training Program.

Lateral officers shall be required to successfully complete, at a minimum, a 10-week Field Training Program.

To the extent practical, entry level and lateral officers should be assigned to a variety of Field Training Officers, shifts, and geographical areas during their Field Training Program.

415.5.1 FIELD TRAINING MANUAL

Each new officer will be issued an electronic version of the Field Training Manual at the beginning of his/her Primary Training Phase. The manual will outline the FTO program, as well as the areas in which each new and lateral officer will be graded in and the grading standards used.

415.6 EVALUATIONS

Evaluations are an important component of the training process and shall be completed as outlined in the FTO manual.

415.7 DOCUMENTATION

All documentation of the Field Training Program will be retained in the officer's training files and will consist of the following:

- (a) Daily Trainee Performance Evaluations.
- (b) End of phase evaluations.

415.8 REVISIONS

Enacted: March 26, 2018

Aircraft Accidents

416.1 PURPOSE AND SCOPE

The purpose of this policy is to provide department members with guidelines for handling aircraft accidents.

This policy does not supersede, and is supplementary to, applicable portions of the Crime and Disaster Scene Integrity, Emergency Operations Plan and Hazardous Material Response policies.

416.1.1 DEFINITIONS

Definitions related to this policy include:

Aircraft - Any fixed wing aircraft, rotorcraft, balloon, blimp/dirigible or glider that is capable of carrying a person or any unmanned aerial vehicle other than those intended for non-commercial recreational use.

416.2 POLICY

It is the policy of the Salt Lake City Police Department to provide an appropriate emergency response to aircraft accidents. This includes emergency medical care and scene management.

416.3 ARRIVAL AT SCENE

Officers or other authorized members tasked with initial scene management should establish an inner and outer perimeter to:

- (a) Protect persons and property.
- (b) Prevent any disturbance or further damage to the wreckage or debris, except to preserve life or rescue the injured.
- (c) Preserve ground scars and marks made by the aircraft.
- (d) Manage the admission and access of public safety and medical personnel to the extent necessary to preserve life or to stabilize hazardous materials.
- (e) Maintain a record of persons who enter the accident site.
- (f) Consider implementation of an Incident Command System (ICS).

416.4 INJURIES AND CASUALTIES

Members should address emergency medical issues and provide care as a first priority.

Those tasked with the supervision of the scene should coordinate with the National Transportation Safety Board (NTSB) before the removal of bodies. If that is not possible, the scene supervisor should ensure documentation of what was disturbed, including switch/control positions and instrument/gauge readings.

Salt Lake City Police Department

SLCPD Policy Manual

SLCPD Policy Manual

Aircraft Accidents

416.5 NOTIFICATIONS

When an aircraft accident is reported to this department, the responding supervisor shall ensure notification is or has been made to NTSB, the Federal Aviation Administration (FAA), and when applicable, the appropriate branch of the military.

[Salt Lake City Police Department Procedure Manual: 411.2 NTSB Notification](#)

[Salt Lake City Police Department Procedure Manual: 411.3 FAA Notification](#)

Supervisors shall ensure other notifications are made once an aircraft accident has been reported. The notifications will vary depending on the type of accident, extent of injuries or damage, and the type of aircraft involved. When an aircraft accident has occurred, it is generally necessary to notify the following:

- (a) Fire department
- (b) Appropriate airport tower
- (c) Emergency medical services (EMS)

416.6 CONTROLLING ACCESS AND SCENE AUTHORITY

Prior to NTSB arrival, scene access should be limited to authorized personnel from the:

- (a) FAA.
- (b) Fire department, EMS or other assisting law enforcement agencies.
- (c) Medical Examiner.
- (d) Air Carrier/Operators investigative teams with NTSB approval.
- (e) Appropriate branch of the military, when applicable.
- (f) Other emergency services agencies (e.g., hazardous materials teams, biohazard decontamination teams, fuel recovery specialists, explosive ordnance disposal specialists).

The NTSB has primary responsibility for investigating accidents involving civil aircraft. In the case of a military aircraft accident, the appropriate branch of the military will have primary investigation responsibility.

After the NTSB or military representative arrives on-scene, the efforts of this department will shift to a support role for those agencies.

If NTSB or a military representative determines that an aircraft or accident does not qualify under its jurisdiction, the on-scene department supervisor should ensure the accident is still appropriately investigated and documented.

416.7 DANGEROUS MATERIALS

Members should be aware of potentially dangerous materials that might be present. These may include, but are not limited to:

Salt Lake City Police Department

SLCPD Policy Manual

SLCPD Policy Manual

Aircraft Accidents

- (a) Fuel, chemicals, explosives, biological or radioactive materials and bombs or other ordnance.
- (b) Pressure vessels, compressed gas bottles, accumulators and tires.
- (c) Fluids, batteries, flares and igniters.
- (d) Evacuation chutes, ballistic parachute systems and composite materials.

416.8 DOCUMENTATION

All aircraft accidents occurring within the City of Salt Lake City shall be documented. At a minimum the documentation should include the date, time and location of the incident; any witness statements, if taken; the names of SLCPD members deployed to assist; other City resources that were utilized; and cross reference information to other investigating agencies. Suspected criminal activity should be documented on the appropriate crime report.

416.8.1 WRECKAGE

When reasonably safe, members should:

- (a) Obtain the aircraft registration number (N number) and note the type of aircraft.
- (b) Attempt to ascertain the number of casualties.
- (c) Obtain photographs or video of the overall wreckage, including the cockpit and damage, starting at the initial point of impact, if possible, and any ground scars or marks made by the aircraft.
 - 1. Military aircraft may contain classified equipment and therefore shall not be photographed unless authorized by a military commanding officer (18 USC § 795).
- (d) Secure, if requested by the lead authority, any electronic data or video recorders from the aircraft that became dislodged or cell phones or other recording devices that are part of the wreckage.
- (e) Acquire copies of any recordings from security cameras that may have captured the incident.

416.8.2 WITNESSES

Members tasked with contacting witnesses should obtain:

- (a) The location of the witness at the time of his/her observation relative to the accident site.
- (b) A detailed description of what was observed or heard.
- (c) Any photographs or recordings of the accident witnesses may be willing to voluntarily surrender.
- (d) The names of all persons reporting the accident, even if not yet interviewed.
- (e) Name, address, and phone numbers (home & work) of witnesses.

Salt Lake City Police Department

SLCPD Policy Manual

SLCPD Policy Manual

Aircraft Accidents

416.9 MEDIA RELATIONS

The Public Information Officer (PIO) should coordinate a response to the media, including access issues, road closures, detours and any safety information that is pertinent to the surrounding community. Any release of information regarding details of the accident itself should be coordinated with the NTSB or other authority who may have assumed responsibility for the investigation.

Depending on the type of aircraft, the airline or the military may be responsible for family notifications and the release of victims' names. The PIO should coordinate with other involved entities before the release of information.

416.10 REVISIONS

Enacted: March 26, 2018

Obtaining Air Support

417.1 PURPOSE AND SCOPE

The use of a law enforcement helicopter can be invaluable in certain situations. This policy specifies potential situations where the use of a helicopter may be requested and the responsibilities for making a request.

417.2 REQUEST FOR HELICOPTER ASSISTANCE

If a supervisor or officer in charge of an incident determines that the use of a helicopter would be beneficial, a request to obtain helicopter assistance may be made.

417.2.1 REQUEST FOR ASSISTANCE FROM ANOTHER AGENCY

After consideration and approval of the request for a helicopter, the Watch Commander, or designee, will call the closest agency having helicopter support available. The Watch Commander will apprise that agency of the specific details of the incident prompting the request.

417.2.2 CIRCUMSTANCES UNDER WHICH AID MAY BE REQUESTED

Law enforcement helicopters may be requested under any of the following conditions:

- (a) When the helicopter is activated under existing mutual aid agreements.
- (b) Whenever the safety of law enforcement personnel is in jeopardy and the presence of the helicopters may reduce such hazard.
- (c) When the use of the helicopters will aid in the capture of a suspected fleeing felon whose continued freedom represents an ongoing threat to the community.
- (d) When a helicopter is needed to locate a person who has strayed or is lost and whose continued absence constitutes a serious health or safety hazard.
- (e) Vehicle pursuits.

While it is recognized that the availability of helicopter support will generally provide valuable assistance to ground personnel, the presence of a helicopter will rarely replace the need for officers on the ground.

417.3 REVISIONS

Enacted: March 26, 2018

Detentions and Photographing Detainees

418.1 PURPOSE AND SCOPE

The purpose of this policy is to establish guidelines for conducting field interviews (FI) and pat-down searches, and the taking of photographs of persons detained in the field but not arrested. Due to a variety of situations confronting the officer, the decision to FI or photograph a field detainee shall be left to the discretion of the involved officer based on the totality of the circumstances available at the time of the detention.

418.2 DEFINITIONS

Detention - Occurs when an officer intentionally, through words, actions or physical force causes an individual to reasonably believe he/she is being required to restrict his/her movement. Detentions also occur when an officer actually restrains a person's freedom of movement.

Consensual Encounter - Occurs when an officer contacts an individual but does not create a detention through words, actions or other means. In other words, a reasonable individual would believe that his/her contact with the officer is voluntary.

Field Interview (FI) - The brief detainment of an individual, whether on foot or in a vehicle, based on reasonable suspicion for the purposes of determining the individual's identity and resolving the officer's suspicions.

Field Photographs - Field photographs are defined as posed photographs taken of a person during a contact, detention, or arrest in the field. Undercover surveillance photographs of an individual and recordings captured by the normal operation of a Mobile Audio Video (MAV) system when persons are not posed for the purpose of photographing are not considered field photographs.

Pat-Down Search - This type of search is used by officers in the field to check an individual for weapons. It involves a thorough patting down of clothing to locate any weapons or dangerous items that could pose a danger to the officer, the detainee or others.

Reasonable Suspicion - Occurs when, under the totality of the circumstances, an officer has articulable facts that criminal activity may be afoot and a particular person is connected with that possible criminal activity.

418.3 FIELD INTERVIEWS

Officers may stop individuals for the purpose of conducting an FI where reasonable suspicion is present. In justifying the stop, the officer should be able to point to specific facts which, when taken together with rational inferences, reasonably warrant the stop. Such facts include, but are not limited to, the following:

- (a) The appearance or demeanor of an individual suggests that he/she is part of a criminal enterprise or is engaged in a criminal act.
- (b) The actions of the suspect suggest that he/she is engaged in a criminal activity.

Salt Lake City Police Department

SLCPD Policy Manual

SLCPD Policy Manual

Detentions and Photographing Detainees

- (c) The hour of day or night is inappropriate for the suspect's presence in the area.
- (d) The suspect's presence in the particular area is suspicious.
- (e) The suspect is carrying a suspicious object.
- (f) The suspect's clothing bulges in a manner that suggests he/she is carrying a weapon.
- (g) The suspect is located in proximate time and place to an alleged crime.
- (h) The officer has knowledge of the suspect's prior criminal record or involvement in criminal activity.

418.3.1 INITIATING A FIELD INTERVIEW

An officer may initiate the stop of a person when there is articulable, reasonable suspicion to do so. A person, however, should not be detained longer than is reasonably necessary to resolve the officer's suspicions (Utah Code 77-7-15).

Nothing in this policy is intended to discourage consensual contacts. Frequent and random casual contacts with consenting individuals are encouraged by the Salt Lake City Police Department to strengthen our community involvement, community awareness and problem identification.

418.3.2 WITNESS IDENTIFICATION AND INTERVIEWS

Because potential witnesses to an incident may be lost or the integrity of their statements compromised with the passage of time, officers should, when warranted by the seriousness of the case, take reasonable steps to promptly coordinate with an on-scene supervisor and/or criminal investigators to utilize available personnel for the following:

- (a) Identify all persons present at the scene and in the immediate area.
 - 1. When feasible, a recorded statement should be obtained from those persons who claim not to have witnessed the incident but who were present at the time it occurred.
 - 2. Any potential witness who is unwilling or unable to remain available for a formal interview should not be detained absent reasonable suspicion to detain or probable cause to arrest. Without detaining the individual for the sole purpose of identification, officers should attempt to identify the witness prior to his/her departure.
- (b) Witnesses who are willing to provide a formal interview should be asked to meet at a suitable location where criminal investigators may obtain a recorded statement. Such witnesses, if willing, may be transported by department personnel.
 - 1. A written, verbal or recorded statement of consent should be obtained prior to transporting a witness in a department vehicle. When the witness is a minor, consent should be obtained from the parent or guardian, if available, prior to transportation.

Salt Lake City Police Department

SLCPD Policy Manual

SLCPD Policy Manual

Detentions and Photographing Detainees

418.4 PAT-DOWN SEARCHES

A pat-down search of a detained subject may be conducted whenever an officer reasonably believes that the person may possess an object that can be utilized as an offensive weapon or whenever the officer has a reasonable fear for his/her own safety or the safety of others (Utah Code 77-7-16). Circumstances that may establish justification for performing a pat-down search include, but are not limited to the following:

- (a) The type of crime suspected, particularly in crimes of violence where the use or threat of deadly weapons is involved.
- (b) Where more than one suspect must be handled by a single officer.
- (c) The hour of the day and the location or neighborhood where the stop takes place.
- (d) Prior knowledge of the suspect's use of force and/or propensity to carry offensive or deadly weapons.
- (e) The appearance and demeanor of the suspect.
- (f) Visual indications which suggest that the suspect is carrying a firearm or other weapon.
- (g) The age and gender of the suspect.

Whenever possible, pat-down searches should be performed by officers of the same gender.

418.5 FIELD PHOTOGRAPHS

Before photographing any field detainee, the officer shall carefully consider, among other things, the factors listed below.

418.5.1 FIELD PHOTOGRAPHS TAKEN WITH CONSENT

Field photographs may be taken when the subject of the photograph knowingly and voluntarily gives consent.

418.5.2 FIELD PHOTOGRAPHS TAKEN WITHOUT CONSENT

Field photographs may be taken without consent only if they are taken during a detention that is based on reasonable suspicion of criminal activity, and the photograph serves a legitimate law enforcement purpose related to the detention. Mere knowledge or suspicion of gang membership or affiliation is not a sufficient justification for taking a photograph without consent. The officer must be able to articulate facts that reasonably indicate that the subject was involved in, or was about to become involved in, criminal conduct.

If, prior to taking a photograph, the officer's reasonable suspicion of criminal activity has been dispelled, the detention must cease and the photograph should not be taken.

418.5.3 GANG AFFILIATION JUVENILE PHOTOS

SLCPD officers will not photograph juveniles holding whiteboards identifying gang affiliation.

Salt Lake City Police Department

SLCPD Policy Manual

SLCPD Policy Manual

Detentions and Photographing Detainees

418.6 SUPERVISOR RESPONSIBILITY

While it is recognized that field photographs often become valuable investigative tools, supervisors should monitor such practices in view of the above listed considerations. This is not to imply that supervisor approval is required before each photograph. Access to field photographs shall be strictly limited to law enforcement purposes.

418.7 DISPOSITION OF PHOTOGRAPHS

All detainee photographs must be adequately labeled and submitted with either an associated FI card (this includes Street Checks) or other report explaining the nature of the contact.

418.8 REVISIONS

Enacted: March 26, 2018

Revised: September 7, 2018

Criminal Intelligence

419.1 PURPOSE AND SCOPE

The purpose of this policy is to ensure that the Salt Lake City Police Department appropriately utilizes criminal intelligence systems and temporary information files to support investigations of criminal organizations and enterprises.

419.1.1 DEFINITIONS

Definitions related to this policy include:

Criminal Intelligence System (CIS) - Any record system that receives, stores, exchanges or disseminates information that has been evaluated and determined to be relevant to the identification of a criminal organization or enterprise, its members or affiliates. This does not include temporary information files or tips produced by the department's web based tip service.

Criminal Predicate - Criminal intelligence information which supports the finding that there is reasonable suspicion to believe that a person, group, association, or organization is engaged in definable criminal activity. This term is the standard for determination of whether information is entered into, or continued to be retained in, a criminal intelligence system.

419.2 POLICY

The Salt Lake City Police Department recognizes that certain criminal activities, including but not limited to gang crimes and drug trafficking, often involve some degree of regular coordination and may involve a large number of participants over a broad geographical area.

It is the policy of this department to collect and share relevant information while respecting the privacy and legal rights of the public.

419.3 CRIMINAL INTELLIGENCE SYSTEMS

No department member may create, submit to, or obtain information from a criminal intelligence system unless the Chief of Police or their designee has approved the system for department use.

Any criminal intelligence system approved for department use should meet or exceed the standards of 28 CFR 23.20.

A designated supervisor will be responsible for maintaining each criminal intelligence system that has been approved for department use. The supervisor or the authorized designee should ensure the following:

- (a) Members using any such system are appropriately selected and trained.
- (b) Use of every criminal intelligence system is appropriately reviewed and audited.
- (c) Any system security issues are reasonably addressed.

419.3.1 SYSTEM ENTRIES

It is the designated supervisor's responsibility to approve the entry of any information from a report, field interview (FI), photo, or other relevant document into an authorized criminal intelligence

Salt Lake City Police Department

SLCPD Policy Manual

SLCPD Policy Manual

Criminal Intelligence

system. If entries are made based upon information that is not on file with this department, such as open or public source documents or documents that are on file at another agency, the designated supervisor should ensure copies of those documents are retained by the Records Unit. Any supporting documentation for an entry shall be retained by the Records Unit in accordance with the established records retention schedule and for at least as long as the entry is maintained in the system.

All data in a criminal intelligence system should not exceed five years in the system. The data must be removed before the expiration date. However, data may be retained indefinitely if there is information that demonstrates the continued validity of the criminal predicate, or another criminal predicate has been documented, within the last five years.

419.3.2 DISSEMINATION, STORAGE, AND SECURITY

Criminal intelligence systems include but are not limited to the department's Gang File. All criminal Intelligence Systems utilized within this department will be subject to the following regulations as outlined in Title 28 CFR 23.20:

- (a) Information in a criminal intelligence system shall only be disseminated where there is a need-to-know and a right-to-know the information in the performance of a law enforcement activity. Exceptions to this are:
 - i. If an outside law enforcement authority agrees to follow procedures regarding information receipt, maintenance, security, and dissemination which are consistent with those found in Title 28 CFR 23.20.
 - ii. If the dissemination of criminal intelligence to any other individual will prevent imminent danger to life or property.
- (b) When disseminating information, a record indicating who has been given information, the reason for the release of the information, and the date of each dissemination outside those who have access to the system shall be documented.
- (c) The criminal intelligence system must store information in a such a manner that the information cannot be modified, accessed, or purged without authorization.
- (d) Criminal intelligence systems must institute procedures that will protect physical aspects of the system from tampering, damage, theft, or disaster.

419.3.3 DATA REVIEWS

The Audit and Inspections Unit shall review the data at least once per year, ensuring that the data entered into the system meets the criteria established in Title 28 CFR 23.20. Audits that are performed must contain the following elements:

- (a) All the data in the system that is considered misleading, obsolete, or otherwise unreliable must be removed. If it is discovered that information in the system was collected in a manner that violates federal, state, or local laws, the data will be immediately removed and the related file on a subject or organization will be reviewed to determine if it needs to be purged as well.

Salt Lake City Police Department

SLCPD Policy Manual

SLCPD Policy Manual

Criminal Intelligence

- (b) The audit must verify that proper procedures and practices are used to access, disseminate, and enter new information.
- (c) Justification for why data is being retained, along with the reviewer's name and the date of the review, shall be provided.

419.4 TEMPORARY INFORMATION FILE

No member may create or keep files on individuals that are separate from an approved criminal intelligence system. However, members may maintain temporary information that is necessary to actively investigate whether a person or group qualifies for entry into a department-approved CIS only as provided in this section. Once information qualifies for inclusion, it should be submitted to the supervisor responsible for consideration of CIS entries. Information that is deemed irrelevant to criminal investigations will be purged periodically at the discretion of the corresponding supervisor, to ensure only necessary data being used for active investigations is retained.

419.4.1 COMMUNITY AND OUTSIDE AGENCY GENERATED TIPS

The Salt Lake City Police Department utilizes an online tip service to allow community members to submit information anonymously about possible criminal activity. This service records each tip along with the date it is received. When a tip is submitted by a community member, a notification is sent to the Salt Lake Information Center (SLIC). Access to this system is password protected and access is restricted to members of the Salt Lake Information Center. Those with access to the system are able to enter the online web service and view the details of the tip. Once a tip has been reviewed, one of the following actions should be taken:

- (a) If the tip has sufficient information for follow-up and an address, a case will be generated and forwarded to the appropriate Unit for additional investigation.
- (b) If the tip has sufficient information for follow-up but refers to an area instead of a specific address, the details of the tip will be forwarded to the appropriate Unit supervisor, by email, for additional investigation. How this information is handled is left to the discretion of the supervisor receiving the email.
- (c) If the tip does not have sufficient information (i.e., no suspect information, no specific address) for additional investigation, but may contain valuable information related to open cases or known trends for an area, it will be forwarded to the appropriate Unit supervisor by email. These emails may be incorporated into an active investigation or deleted at the discretion of the supervisor receiving the information.
- (d) Tips that do not meet the threshold for additional follow-up are deleted from the online tips service.

Outside agencies may submit tips through the SLIC as well. Such exchanges of information should be documented. Once the information has been dispersed to the appropriate supervisor, it is up to their discretion to determine how the information is handled.

Salt Lake City Police Department

SLCPD Policy Manual

SLCPD Policy Manual

Criminal Intelligence

419.5 INFORMATION RECOGNITION

Department members should document facts that suggest an individual, organization, or enterprise is involved in criminal activity and should forward that information appropriately. Examples include, but are not limited to:

- (a) Gang indicia associated with a person or residence.
- (b) Information related to a drug-trafficking operation.
- (c) Vandalism indicating an animus for a particular group.
- (d) Information related to an illegal gambling operation.

Department supervisors who utilize an authorized criminal intelligence system should work with the Training Lieutenant to train members to identify information that may be particularly relevant for inclusion.

419.6 RELEASE OF INFORMATION

Department members shall comply with the rules of an authorized criminal intelligence system regarding inquiries and release of information.

Information from a temporary information file may only be furnished to department members and other law enforcement agencies on a need-to-know basis and consistent with the Records Maintenance and Release Policy.

When an inquiry is made by the parent or guardian of a juvenile as to whether that juvenile's name is in a temporary information file, such information should be provided by the supervisor responsible for the temporary information file, unless there is good cause to believe that the release of such information might jeopardize an ongoing criminal investigation.

419.7 CRIMINAL STREET GANGS

The Gang Unit Sergeant should ensure that there are an appropriate number of department members who can:

- (a) Testify as experts on matters related to criminal street gangs, and maintain an above average familiarity with identification of criminal street gangs, criminal street gang members and patterns of criminal gang activity, as described in Utah Code 76-9-802 et seq. and Utah Code 76-9-902 et seq.
- (b) Coordinate with other agencies in the region regarding criminal street gang crimes and information.
- (c) Train other members to identify gang indicia and investigate criminal street gang-related crimes.

419.8 TRAINING

The supervisor of each affected Unit should provide training on best practices in the use of each authorized criminal intelligence system to those tasked with investigating criminal organizations and enterprises. Training should include:

- (a) The protection of civil liberties.

Salt Lake City Police Department

SLCPD Policy Manual

SLCPD Policy Manual

Criminal Intelligence

- (b) Participation in a multiagency criminal intelligence system, if applicable.
- (c) Submission of information into a multiagency criminal intelligence system or the receipt of information from such a system, including any governing federal and state rules and statutes, if applicable.
- (d) The type of information appropriate for entry into a criminal intelligence system or temporary information file.
- (e) The review and purging of temporary information files.

419.9 REVISIONS

Enacted: March 26, 2018

Revised: February 22, 2023

Watch Commanders

420.1 PURPOSE AND SCOPE

Each patrol shift must be directed by supervisors who are capable of making decisions and communicating in a manner consistent with Department policies, procedures, practices, functions and objectives. To accomplish this goal, a Lieutenant commands each watch. The Watch Commander represents the Office of the Chief, overseeing day-to-day field operations to ensure that orders and procedures are properly executed and professional standards are maintained.

420.2 DESIGNATION AS ACTING WATCH COMMANDER

When a Lieutenant is unavailable for duty as Watch Commander, in most instances the Liberty and Pioneer Patrol Division Captains will act as the Watch Commander. Some instances may require designating an acting Watch Commander from the Lieutenant's promotion eligibility list.

420.3 WATCH COMMANDER RESPONSIBILITIES

As the Department's administrative representative, the on-duty Watch Commander is responsible to remain available to the Patrol Division Commanders and the Chief of Police. It is also the responsibility of the Watch Commander to oversee major crime scenes and take command in the absence of a supervisor.

It is mandatory that the on-duty Watch Commander personally oversee the following until relieved or resolved:

- (a) Incidents involving injury or death of an officer.
- (b) Incidents in which serious injury or death of a citizen result from an officer's actions.
- (c) Major incidents that require their direct command.

At their discretion, the Watch Commander may oversee any situation they feel is necessary, to include:

- (a) Consulting with supervisors regarding the execution of procedures.
- (b) Ensuring that proper notifications of major incidents are made.
- (c) Responding to inquiries from the media in the absence of the Public Information Officer.

420.4 SIGNIFICANT INCIDENTS/WATCH COMMAND LOG

Significant incidents are specific incidents that are identified by the department as the highest priority because of their relationship to the department's crime reduction goals, their seriousness, or their political and social nature.

Significant incidents include but are not limited to the following:

- (a) Suspicious deaths
- (b) Shootings
- (c) Stabbings

Salt Lake City Police Department

SLCPD Policy Manual

SLCPD Policy Manual

Watch Commanders

- (d) Robberies
- (e) Serious violent gang-involved crime
- (f) Forcible sexual assaults
- (g) Abductions/Missing children
- (h) Serious aggravated assault committed by strangers
- (i) Property crime involving City property or City employees as victims or suspects
- (j) Missing adults under suspicious circumstances
- (k) Officer involved accidents
- (l) Hazardous Device Unit call-outs
- (m) SWAT operations
- (n) Hate crimes
- (o) Potential terrorist acts
- (p) Significant crime sprees
- (q) Any event requiring significant resources
- (r) Officer safety incidents

Watch Commanders are responsible for gathering the details of the above incidents from the initial officer or on-scene supervisor and including them on the Watch Command Log.

420.5 REVISIONS

Enacted: March 26, 2018

Mobile Data Terminal Use

421.1 PURPOSE AND SCOPE

The purpose of this policy is to establish guidelines for the proper access, use and application of the Mobile Data Terminal (MDT) system in order to ensure appropriate access to confidential records from local, state and national law enforcement databases, and to ensure effective electronic communications between department members and Dispatch.

421.2 POLICY

Salt Lake City Police Department members using the MDT shall comply with all appropriate federal and state rules and regulations and shall use the MDT in a professional manner, in accordance with this policy.

421.3 PRIVACY EXPECTATION

Members forfeit any expectation of privacy with regard to messages accessed, transmitted, received or reviewed on any department technology system (see the Information Technology Use Policy for additional guidance).

All messages sent via an MDT are retrievable, are public information, and are subject to discovery.

421.4 RESTRICTED ACCESS AND USE

MDT use is subject to the Information Technology Use and Protected Information policies.

Members shall not access the MDT system if they have not received prior authorization and the required training. Members shall immediately report unauthorized access or use of the MDT by another member to their supervisors or Watch Commanders.

Use of the MDT system to access law enforcement databases or transmit messages is restricted to official activities, business-related tasks and communications that are directly related to the business, administration or practices of the Department.

MDT users should limit messages to the main channel dispatcher (Pioneer and Liberty). Information or questions regarding a call may be sent via message to the service channel dispatcher or call-taker.

Sending derogatory, defamatory, obscene, disrespectful, sexually suggestive, harassing or any other inappropriate messages on the MDT system is prohibited and may result in discipline.

It is a violation of this policy to transmit a message or access a law enforcement database under another member's name or to use the password of another member to log in to the MDT system unless directed to do so by a supervisor. Members are required to log off the MDT or secure the MDT when it is unattended. This added security measure will minimize the potential for unauthorized access or misuse.

Salt Lake City Police Department

SLCPD Policy Manual

SLCPD Policy Manual

Mobile Data Terminal Use

421.4.1 STATUS CHANGES AND LOG UPDATES

Status changes (i.e., en-route, arrived, in-service) can be made by the officer via the MDT, but must also be voiced over the radio.

Officers may update the case log via the MDT.

421.4.2 USE WHILE DRIVING

Use of the MDT by the vehicle operator should be limited while the vehicle is in motion.

421.5 MALFUNCTIONING MDT

If an MDT is not functioning, a member will contact their direct supervisor as soon as possible. If the problem is not able to be resolved, the officer will contact the Quartermaster to get a loaner MDT until their MDT can be fixed. Officers shall follow proper procedure for submitting MDT's to IMS for service/repairs. [Salt Lake City Police Department Procedure Manual: 700.2 IMS ASSISTANCE REQUEST](#)

421.6 REVISIONS

Enacted: March 26, 2018

Portable Audio/Video Recorders

422.1 PURPOSE AND SCOPE

This policy governs the use of portable audio/video recording devices by members of this department while in the performance of their duties, including body-worn cameras.

This policy does not apply to interviews or interrogations conducted at any Salt Lake City Police Department facility, undercover operations, or wiretaps.

Additional policies regarding the use of body-worn cameras during the execution of a warrant is found in the Warrant Service Policy.

422.1.1 DEFINITIONS

Body-Worn Camera - A video recording device that is issued to and carried by, or worn on the body of, a department member and that is capable of recording the operations of the department member (Utah Code 77-7a-103(1)(a)). Body-worn cameras do not include dashboard mounted cameras or cameras intended to record clandestine investigation activities (Utah Code 77-7a-103(1)(b)).

Law Enforcement Encounter - A Law Enforcement Encounter shall have the meaning as set forth by Utah Code 77-7a-103(3) or its successor provision.

422.2 POLICY

The Salt Lake City Police Department may provide members with access to portable recorders, either audio or video or both, for use during the performance of their duties. With the exception of members of the department who have positions or job duties that do not warrant wearing a body-worn camera, all members shall wear their department issued body-worn camera while on-duty. The use of recorders is intended to enhance the mission of the department by accurately capturing contacts between members of the department and the public.

422.3 BODY-WORN CAMERAS

422.3.1 BODY-WORN CAMERA COORDINATOR

The Chief of Police or the authorized designee should designate a body-worn camera coordinator responsible for establishing procedures for (Utah Code 77-7a-102):

- (a) The security, storage and maintenance of data and recordings.
- (b) Accessing data and recordings.
- (c) Logging or auditing access.
- (d) Transferring, downloading, tagging or marking events.
- (e) Initial and ongoing training for officers and supervisors in the use of body-worn cameras and evidence.com.

Salt Lake City Police Department

SLCPD Policy Manual

SLCPD Policy Manual

Portable Audio/Video Recorders

- i. Any member assigned a body-worn camera should receive this policy and associated procedure, as well as training on how to operate a body-worn camera, before utilization.

422.3.2 MEMBER RESPONSIBILITIES

Each department member who has been issued a body-worn camera will be responsible for making sure that the camera is in good working order. If the recorder is not in working order or the department member becomes aware of a malfunction at any time, the department member shall promptly report the failure to their supervisor and obtain a functioning device as soon as reasonably practicable. Department members shall wear the recorder in a conspicuous manner.

All body-worn camera recordings must be downloaded by the department member at the end of their assigned shift unless an exception is authorized by a supervisor.

422.3.3 ACTIVATION OF THE BODY-WORN CAMERA

Unless expressly prohibited by state law, a body-worn camera shall be activated prior to (or as soon as reasonably possible) any law enforcement encounter.

State law expressly prohibits the activation of a body-worn camera inside a hospital, health care facility, human service program, or the clinic of a health care provider except during a law enforcement encounter (77-7a-104(11)(b)).

In order to ensure department members capture the law enforcement encounter, it is recommended that department members activate their body-worn camera immediately after acknowledging a call for service, prior to arriving in the area, or immediately after notifying Dispatch of their intent to engage in a law enforcement action. Proper body-worn camera activation procedures shall be followed. [Salt Lake City Police Department Procedure Manual: 408.2 BODY-WORN CAMERA ACTIVATION PROCEDURES](#)

At no time is a member expected to jeopardize their safety, the safety of another, or the safety of the general public in order to activate a body-worn camera (Utah Code 77-7a-102). However, the camera should be activated as soon as reasonably practicable (Utah Code 77-7a-104).

422.3.4 CESSATION OF RECORDING

Unless expressly provided herein, once activated, the camera shall remain on in an uninterrupted manner (including audio recording capabilities) until the conclusion of the law enforcement encounter and the department member has returned to their vehicle. A department member may deactivate or mute the audio recording capabilities of their body-worn camera in the following scenarios:

- (a) During significant periods of inactivity including, but not limited to, report writing or other breaks from direct participation in the incident, including consultation with a supervisor or other officer.
- (b) When consulting with a supervisor or other officer.

Salt Lake City Police Department

SLCPD Policy Manual

SLCPD Policy Manual

Portable Audio/Video Recorders

- (c) When speaking with a victim, witness, or person wishing to report or discuss criminal activity if both of the following apply:
 - (a) The subject of the recording requests deactivation.
 - (b) The member believes the value of the information outweighs the value of the potential recording.
- (d) During a conversation with a victim of a sexual offense or domestic violence if:
 - (a) The member is conducting an evidence-based lethality assessment.
 - (b) The victim or the member believes that deactivating the body-worn camera recording will either:
 - 1. Encourage complete and accurate information sharing by the victim, or
 - 2. Is necessary to protect the safety or identity of the victim; and
 - 3. The body-worn camera is reactivated as soon as reasonably possible after the evidence-based lethality assessment is complete.

When the deactivation is based on a request from a victim, witness, or other person reporting a crime as provided in subsection (c) above, the member should record the request to deactivate the portable recorder.

Prior to early deactivation or muting the audio recording capabilities of the body-worn camera for one of the allowable reasons enumerated above, a department member shall first state the reason for the early deactivation or muting prior to deactivating or muting.

422.3.5 REQUIRED REPORT DOCUMENTATION

Department members shall document in a report or other official record of the contact (such as a general offense report or MDT CAD notes) the following:

- 1. The presence/absence of a Body-Worn Camera and the existence/nonexistence of a recording.
- 2. Any instance where the Department member failed to record a law enforcement encounter or the officer deactivated the camera in violation of this policy (Policy 422), including the reason for the failure or deactivation.

422.3.6 IDENTIFICATION AND PRESERVATION OF BODY-WORN CAMERA RECORDINGS

To assist with identifying and preserving data and recordings members will tag body-worn camera recordings in accordance with department procedure. [Salt Lake City Police Department Procedure Manual: 408.3 TAGGING BODY-WORN CAMERA RECORDINGS](#)

422.3.7 RETENTION OF BODY-WORN CAMERA RECORDINGS

All recordings shall be retained for a period consistent with the requirements of the established records retention schedule and as required by any applicable federal, state and local law (Utah Code 77-7a-107). Department members will follow proper procedure to ensure proper retention of body-worn camera recordings.

Salt Lake City Police Department

SLCPD Policy Manual

SLCPD Policy Manual

Portable Audio/Video Recorders

[Salt Lake City Police Department Procedure Manual: 408.4 RETENTION OF BODY-WORN CAMERA RECORDINGS](#)

422.4 PORTABLE AUDIO RECORDERS

Utah law permits an individual to record any conversation in which one party to the conversation has given their permission (Utah Code 77-23a-4).

Members of the Department may use a portable audio recorder to overtly or surreptitiously record any conversation during the course of a criminal investigation in which the member reasonably believes that such a recording will be lawful and beneficial to the investigation.

Divisions who issue and/or utilize portable audio recorders will establish procedures for storage and retention of such recordings.

422.5 MEMBER PRIVACY EXPECTATION

Members shall not surreptitiously record another department member with a portable audio/video recorder without a court order.

All recordings made by members on any department-issued device at any time, and any recording made while acting in an official capacity of this department, regardless of ownership of the device it was made on, shall remain the property of the Department. Members shall have no expectation of privacy or ownership interest in the content of these recordings.

422.6 EXPLOSIVE DEVICE

Many portable recorders, including body-worn cameras and audio/video transmitters, emit radio waves that could trigger an explosive device. Therefore, these devices should not be used where an explosive device may be present.

422.7 PROHIBITED USE OF PORTABLE RECORDERS

Members are prohibited from using department-issued portable recorders and recording media for personal use and are prohibited from making personal copies of recordings created while on-duty or while acting in their official capacity. Members may not alter or delete a recording captured on a portable recorder (Utah Code 77-7a-106).

Members are also prohibited from retaining recordings of activities or information obtained while on-duty whether the recording was created with a department-issued or personally owned recorder. Members shall not duplicate or distribute such recordings, except for authorized legitimate department business purposes. All such recordings shall be retained at the Department (Utah Code 77-7a-106).

Members are prohibited from using personally owned recording devices while on-duty.

Recordings shall not be used by any member for the purpose of embarrassment, harassment or ridicule.

Salt Lake City Police Department

SLCPD Policy Manual

SLCPD Policy Manual

Portable Audio/Video Recorders

422.8 RELEASE OF AUDIO/VIDEO RECORDINGS

Requests for the release of audio/video recordings shall be processed in accordance with the Records Maintenance and Release Policy.

422.9 REVIEW OF RECORDED MEDIA FILES

When preparing written reports, members should review their recordings as a resource (see the Officer-Involved Critical Incidents Policy for guidance in those cases). However, members shall not retain personal copies of recordings. Members should not use the fact that a recording was made as a reason to write a less detailed report.

Supervisors are authorized to review relevant recordings any time they are investigating alleged misconduct or reports of meritorious conduct or whenever such recordings would be beneficial in reviewing the member's performance.

Recorded files may also be reviewed:

- (a) Upon approval by a supervisor, by any member of the Department who is participating in an official investigation, such as a personnel complaint, administrative investigation or criminal investigation.
- (b) Pursuant to lawful process or by court personnel who are otherwise authorized to review evidence in a related case.
- (c) By media personnel with permission of the Chief of Police or the authorized designee.
- (d) In compliance with a public records request, if permitted, and in accordance with the Records Maintenance and Release Policy.

All recordings should be reviewed by the GRAMA Coordinator or designee prior to public release (see the Records Maintenance and Release Policy). Recordings that unreasonably violate a person's privacy or sense of dignity should not be publicly released unless disclosure is required by law or order of the court.

422.10 PUBLIC ACCESS

The Office of the Chief of Police should ensure that this policy is available to the public (Utah Code 77-7a-105).

422.11 REVISIONS

Enacted: March 26, 2018

Revised: May 30, 2018

Revised: June 29, 2020

Revised: October 5, 2020

Revised: March 4, 2021

Revised: October 25, 2022

Public Recording of Law Enforcement Activity

423.1 PURPOSE AND SCOPE

This policy provides guidelines for handling situations in which members of the public photograph or audio/video record law enforcement actions and other public activities that involve members of this department. In addition, this policy provides guidelines for situations where the recordings may be evidence.

423.2 POLICY

The Salt Lake City Police Department recognizes the right of persons to lawfully record members of this department who are performing their official duties. Members of this department will not prohibit or intentionally interfere with such lawful recordings. Any recordings that are deemed to be evidence of a crime or relevant to an investigation will only be collected or seized lawfully.

Officers should exercise restraint and should not resort to highly discretionary arrests for offenses such as interference, failure to comply or disorderly conduct as a means of preventing someone from exercising the right to record members performing their official duties.

423.3 RECORDING LAW ENFORCEMENT ACTIVITY

Members of the public who wish to record law enforcement activities are limited only in certain aspects.

- (a) Recordings may be made from any public place or any private property where the individual has the legal right to be present.
- (b) Beyond the act of photographing or recording, individuals may not interfere with the law enforcement activity. Examples of interference include, but are not limited to:
 - 1. Tampering with a witness or suspect.
 - 2. Inciting others to violate the law.
 - 3. Being so close to the activity as to present a clear safety hazard to the officers.
 - 4. Being so close to the activity as to interfere with an officer's effective communication with a suspect or witness.
- (c) The individual may not present an undue safety risk to the officer, him/herself or others.
- (d) Recording the actions of an officer does not by itself constitute a crime of interference, willful resistance, disorderly conduct or obstruction of justice (Utah Code 76-8-305).

423.4 OFFICER RESPONSE

Officers should promptly request that a supervisor respond to the scene whenever it appears that anyone recording activities may be interfering with an investigation or it is believed that the recording may be evidence. If practicable, officers should wait for the supervisor to arrive before taking enforcement action or seizing any cameras or recording media.

Whenever practicable, officers or supervisors should give clear and concise warnings to individuals who are conducting themselves in a manner that would cause their recording or

Salt Lake City Police Department

SLCPD Policy Manual

SLCPD Policy Manual

Public Recording of Law Enforcement Activity

behavior to be unlawful. Accompanying the warnings should be clear directions on what an individual can do to be compliant; directions should be specific enough to allow compliance. For example, rather than directing an individual to clear the area, an officer could advise the person that he/she may continue observing and recording from the sidewalk across the street.

If an arrest or other significant enforcement activity is taken as the result of a recording that interferes with law enforcement activity, officers shall document in a report the nature and extent of the interference or other unlawful behavior and the warnings that were issued. Officers should record the incident with their department issued body camera in accordance with department policy and procedure.

423.5 SUPERVISOR RESPONSIBILITIES

A supervisor should respond to the scene when requested or any time the circumstances indicate a likelihood of interference or other unlawful behavior.

The supervisor should review the situation with the officer and:

- (a) Request any additional assistance as needed to ensure a safe environment.
- (b) Take a lead role in communicating with individuals who are observing or recording regarding any appropriate limitations on their location or behavior. When practical, the encounter should be recorded.
- (c) When practicable, allow adequate time for individuals to respond to requests for a change of location or behavior.
- (d) Ensure that any enforcement, seizure or other actions are consistent with this policy and constitutional and state law.
- (e) Explain alternatives for individuals who wish to express concern about the conduct of Department members, such as how and where to file a complaint.

423.6 SEIZING RECORDINGS AS EVIDENCE

Officers should not seize recording devices or media unless (42 USC § 2000aa):

- (a) There is probable cause to believe the person recording has committed or is committing a crime to which the recording relates, and the recording is reasonably necessary for prosecution of the person.
 1. Absent exigency or consent, a warrant should be sought before seizing or viewing such recordings. Reasonable steps may be taken to prevent erasure of the recording.
- (b) There is reason to believe that the immediate seizure of such recordings is necessary to prevent serious bodily injury or death of any person.
- (c) The person consents.
 1. To ensure that the consent is voluntary, the request should not be made in a threatening or coercive manner.
 2. If the original recording is provided, a copy of the recording should be provided to the recording party, if practicable. The recording party should be permitted to

Salt Lake City Police Department

SLCPD Policy Manual

SLCPD Policy Manual

Public Recording of Law Enforcement Activity

be present while the copy is being made, if feasible. Another way to obtain the evidence is to transmit a copy of the recording from a device to a department-owned device.

Recording devices and media that are seized will be submitted within the guidelines of the Property and Evidence Policy.

423.7 REVISIONS

Enacted: March 26, 2018

Bicycle Patrol Unit

424.1 PURPOSE AND SCOPE

The Salt Lake City Police Department has established the Bicycle Patrol Unit (BPU) for the purpose of enhancing patrol efforts in the community. Bicycle patrol has been shown to be an effective way to increase officer visibility in congested areas. The quiet operation of the bicycles also can provide a tactical approach to crimes in progress. The purpose of this policy is to provide guidelines for the safe and effective operation of the patrol bicycle.

424.2 POLICY

Patrol bicycles may be used for regular patrol duty, traffic enforcement, parking control or special events. The use of the patrol bicycle will emphasize officers mobility and visibility to the community.

Bicycles may be deployed to any area at all hours of the day or night, according to Department needs and as staffing levels allow.

Requests for specific deployment of bicycle patrol officers shall be coordinated through a Bicycle Patrol Unit supervisor or the Watch Commander.

424.3 TRAINING

Participants in the program must successfully complete the Utah POST 32-hour basic training course or a Department-approved bicycle-training course after acceptance into the program. Thereafter bicycle patrol officers should receive twice yearly in-service training to improve skills and refresh safety, health and operational procedures. The initial training shall minimally include the following:

- Bicycle patrol strategies
- Bicycle safety and accident prevention
- Operational tactics using bicycles

424.4 UNIFORMS AND EQUIPMENT

Officers shall wear the Department-approved uniform and safety equipment while operating the department bicycle. Safety equipment includes Department-approved helmet and approved footwear.

Optional equipment includes a radio head set and microphone. In colder weather, turtleneck shirts or sweaters are permitted when worn under the uniform shirt.

Bicycle patrol officers shall carry the same equipment on the bicycle patrol duty belt as they would on a regular patrol assignment.

Officers will be responsible for obtaining the necessary forms, citation books and other department equipment needed while on bicycle patrol.

Salt Lake City Police Department

SLCPD Policy Manual

SLCPD Policy Manual

Bicycle Patrol Unit

424.5 CARE AND USE OF PATROL BICYCLES

- (a) Officers will be assigned a specially marked and equipped patrol bicycle, attached gear bag, and bicycle rack.
- (b) Bicycles utilized for uniformed bicycle patrol shall be equipped with rear reflectors and front lights, satisfying the requirements of Utah Code 41-6a-1114.
- (c) Bicycles utilized for uniformed bicycle patrol shall be equipped with a rear rack and/or saddle bag(s) sufficient to carry all necessary equipment to handle routine patrol calls, including report writing, vehicle impounds, and citations.
- (d) Each bicycle gear bag shall include a first aid kit, tire pump, repair tool, and tire tube. These items are to remain with/on the bicycle at all times.
- (e) Bicycle officers shall conduct an inspection of the bicycle and equipment prior to use to ensure proper working order of the equipment. Officers are responsible for the routine care and maintenance of their assigned equipment (e.g., tire pressure, chain lubrication, overall cleaning, etc.)
- (f) Officers shall not modify the patrol bicycle, remove, modify or add components except with the expressed approval of a bicycle supervisor or in the event of an emergency.
- (g) Bicycles shall be properly secured when not in the officer's immediate possession.

424.5.1 REPAIR/MAINTENANCE BY OUTSIDE VENDORS

Each bicycle will have scheduled maintenance once a year, to be performed by a Department-approved repair shop/technician. An officer will follow the proper procedure for obtaining this annual maintenance.

If a needed repair is beyond the ability of a bicycle officer, the officer will notify a BPU supervisor and follow the proper procedure for obtaining the needed repair from the Department-approved repair shop/technician.

[Salt Lake City Police Department Procedure Manual: 410.2 REPAIR/MAINTENANCE BY OUTSIDE VENDORS](#)

424.6 OFFICER RESPONSIBILITY

Officers should operate the bicycle in compliance with the Utah Code under normal operation. Officers may operate the bicycle without lighting equipment during hours of darkness when such operation reasonably appears necessary for officer safety and tactical considerations. Officers must use caution and care when operating the bicycle without lighting equipment.

Officers are exempt from the rules of the road under the following conditions:

- (a) In response to an emergency call.
- (b) While engaged in rescue operations.

Salt Lake City Police Department

SLCPD Policy Manual

SLCPD Policy Manual

Bicycle Patrol Unit

- (c) In the immediate pursuit of an actual or suspected violator of the law.
- (d) When deemed necessary for bicycle patrol operations.

424.7 BICYCLE PATROL UNIT SUPERVISORS

BPU supervisors consist of the Strategic Deployment Lieutenant, and the BPU Sergeants he/she commands.

BPU supervisors shall have the responsibility for the following:

- (a) Organizing bicycle patrol training.
- (b) Inspecting and maintaining inventory of patrol bicycles and program equipment.
- (c) Scheduling maintenance and repairs.
- (d) Evaluating performance of bicycle officers.
- (e) Coordinating activities with other Divisions.
- (f) Other activities as required to maintain the efficient operation of the BPU.

424.8 REVISIONS

Enacted: March 26, 2018

Foot Pursuits

425.1 PURPOSE AND SCOPE

This policy provides guidelines to assist officers in making the decision to initiate or continue the pursuit of suspects on foot.

425.2 POLICY

It is the policy of the department that officers, when deciding to initiate or continue a foot pursuit, must continuously balance the objective of apprehending the suspect with the risk and potential for injury to department members and the public.

Officers are expected to act reasonably, based on the totality of the circumstances.

425.3 DECISION TO PURSUE

The safety of department members and the public should be the primary consideration when determining whether a foot pursuit should be initiated or continued.

Deciding to initiate or continue a foot pursuit is a decision that an officer must make quickly and under unpredictable and dynamic circumstances. It is recognized that foot pursuits may place department members and the public at significant risk. Therefore, no officer or supervisor shall be criticized or disciplined for deciding not to engage in a foot pursuit because of the perceived risk involved.

In deciding whether to initiate or continue a foot pursuit, an officer can consider reasonable alternatives to pursuit based upon the circumstances and resources available, such as:

- (a) Containment of the area.
- (b) Saturation of the area with law enforcement personnel, including assistance from other agencies.
- (c) A canine search.
- (d) Air support.
- (e) Apprehension at another time when the identity of the suspect is known or there is information available that would likely allow for later apprehension, and the need to immediately apprehend the suspect does not reasonably appear to outweigh the risk of continuing the foot pursuit.

425.4 RESPONSIBILITIES IN FOOT PURSUITS

425.4.1 INITIATING OFFICER RESPONSIBILITIES

Unless relieved by another officer or a supervisor, the initiating officer shall be responsible for coordinating the progress of the pursuit.

Early communication of available information from the involved officers is essential so that adequate resources can be coordinated and deployed to bring a foot pursuit to a safe conclusion.

Salt Lake City Police Department

SLCPD Policy Manual

SLCPD Policy Manual

Foot Pursuits

Officers initiating a foot pursuit should broadcast the following information as soon as it becomes practicable and available:

- (a) Location and direction of travel
- (b) Call sign identifier
- (c) Reason for the foot pursuit, such as the crime classification
- (d) Number of suspects and description, to include name if known
- (e) Whether the suspect is known or believed to be armed with a dangerous weapon

Officers should be mindful that radio transmissions made while running may be difficult to understand and may need to be repeated.

If the foot pursuit is discontinued for any reason, immediate efforts for containment should be established and alternatives considered based upon the circumstances and available resources.

When a foot pursuit terminates, the officer will notify communications with his/her location, the status of the pursuit termination (e.g., suspect in custody, lost sight of suspect) and direct further actions as reasonably appear necessary, to include requesting medical aid as needed for officers, suspects or members of the public.

425.4.2 ASSISTING OFFICER RESPONSIBILITIES

Whenever any officer announces that he/she is engaged in a foot pursuit all other officers should minimize non-essential radio traffic in order to permit the involved officers maximum access to the radio frequency.

Due to the inherent danger of foot pursuits, an emergency response to assist is authorized when assisting units are within a distance reasonably close enough to offer assistance. When responding Code 3, officers will conform to the requirements of the Officer Response to Calls Policy.

425.4.3 SUPERVISOR RESPONSIBILITIES

The supervisor should restrict the channel for non-emergency traffic.

The supervisor shall continuously assess the situation in order to ensure the foot pursuit is conducted within established department guidelines.

Upon the apprehension of the suspect the supervisor shall promptly proceed to the termination point to direct the post-pursuit activity.

425.4.4 DISPATCH RESPONSIBILITIES

Upon notification or becoming aware that a foot pursuit is in progress, the dispatcher is responsible for:

- (a) Clearing the radio channel of non-emergency traffic.
- (b) Coordinating pursuit communications of the involved officers.

Salt Lake City Police Department

SLCPD Policy Manual

SLCPD Policy Manual

Foot Pursuits

- (c) Broadcasting pursuit updates as well as other pertinent information as necessary.
- (d) Ensuring that a field supervisor is notified of the foot pursuit.
- (e) Notifying and coordinating with other involved or affected agencies as practicable.
- (f) Notifying the Watch Commander as soon as practicable.
- (g) Assigning an incident number and logging all pursuit activities.

425.4.5 PLAN "C"

In the event that a suspect is lost during a foot pursuit and containment on an area must be established, officers may wish to utilize a Plan 'C'. In these instances, officers will follow proper procedure. [Salt Lake City Police Department Procedure Manual: 400.2 PLAN "C" PROCEDURE](#)

425.5 REPORTING REQUIREMENTS

The initiating officer shall complete appropriate crime/arrest reports. Any use of force shall be reported and documented in compliance with the Use of Force Policy.

Assisting officers taking an active role in the apprehension of the suspect shall complete supplemental reports as necessary or as directed.

425.6 REVISIONS

Enacted: March 26, 2018

Automated License Plate Readers (ALPRs)

426.1 PURPOSE AND SCOPE

Automated License Plate Reader (ALPR) technology, also known as License Plate Recognition, provides automated detection of license plates. ALPRs are used by the Salt Lake City Police Department to convert data associated with vehicle license plates for official law enforcement purposes, including, but not limited to, identifying stolen or wanted vehicles, stolen license plates, and missing persons. ALPRs may also be used to gather information related to active warrants, homeland security, electronic surveillance, suspect interdiction, and stolen property recovery.

This policy establishes guidelines for authorized department personnel using License Plate recognition technology and applies to all members of the department.

426.2 LICENSE PLATE RECOGNITION TECHNOLOGY

License Plate Recognition (LPR) technology is a computer-based, information-gathering system. The LPR system utilizes specially designed cameras to rapidly capture an image of a vehicle license plate and convert the plate characters into a text file using optical character recognition technology. The text file can then be compared against pre-existing data files. If a match is found, the LPR user is notified by an audible alert and an associated notation on the user's computer screen. Because the LPR system is programmed to check all vehicles in the same manner, they are an objective non-discriminatory public safety tool. The data obtained by LPR systems are useful in criminal investigations.

426.3 ADMINISTRATION OF ALPR EQUIPMENT AND DATA

All installation and maintenance of ALPR equipment, as well as ALPR data access shall be managed by the Investigations Division Commander, or his/her designee. The Investigations Division Commander will assign the Auto Theft Sergeant to be the primary LPR system administrator.

426.4 LPR OPERATION AND AUTHORIZED USES

LPR systems have proven to be very effective law enforcement tools in combating crime. LPR operation and access shall be for official and legitimate law enforcement purposes only (U.C.A. 41-6a-2004) and are not open to the public. Legitimate law enforcement purposes and applications include but are not limited to the following:

- (a) Locating stolen or wanted vehicles or those vehicles that are subject to an investigation.
- (b) Locating witnesses and victims of violent crimes.
- (c) Locating missing or abducted children and at-risk individuals.
- (d) Activities related to homeland security.
- (e) Suspect interdiction.

Salt Lake City Police Department

SLCPD Policy Manual

SLCPD Policy Manual

Automated License Plate Readers (ALPRs)

426.4.1 LPR OPERATION AND STRATEGIES

- (a) An LPR shall only be used for official and legitimate law enforcement business (Utah Code 41-6a-2004).
- (b) LPR-equipped vehicles should be deployed as frequently as possible to maximize the utilization of the system.
- (c) LPR cameras may be deployed to fixed points in the city to meet the needs of the department.
- (d) Regular operation of LPR mobile systems should be considered to be an enhanced extension of an officer's regular patrol efforts to observe and detect vehicles of interest and specific wanted vehicles.
- (e) The use of LPR mobile systems to conduct license plate canvasses and grid searches is encouraged. Particularly for major crimes or incidents as well as areas that are experiencing any type of crime series.
- (f) LPR systems may be legitimately used to collect data that is within public view; however, should not be used to gather intelligence on First Amendment activities.
- (g) Reasonable suspicion or probable cause is not required for the operation of LPR mobile systems and fixed cameras.
- (h) No member of this department shall operate LPR equipment or access LPR data without first completing department-approved training.
 - i. The Auto Theft Sergeant is responsible for providing LPR training.

426.4.2 LPR ALERTS

Alerts for general NCIC related hits will be sent to dispatch via email or text message as decided upon by dispatch protocols. Specific hot plates may be entered by detectives, officers, and/or analysts for specific cases. In these instances the case number and reason are documented in the hot plate entry. When entering a hot plate that has been entered into a watch list, it must be noted who will be alerted if the hot plate is scanned by any LPR system.

426.4.3 LPR MOBILE SYSTEMS OPERATION

LPR informational data files are periodically updated with different data sources being refreshed at different intervals. Therefore, it is important that LPR users take into account the potential for the lag time between the last update and an alert provided by the LPR system on a vehicle of interest or a wanted vehicle. Any alert provided by an LPR system is to be considered informational and advisory in nature; which requires further verification before action can be taken.

When alerted that a vehicle is wanted, stolen, or of interest to law enforcement, the mobile operator should, to the fullest extent possible, take the following steps:

- (a) Ensure the plate was read properly and that the state of origin is consistent with the alert.
- (b) Confirm the alert status by either manually entering the plate via the MDT or requesting the check through dispatch.

Salt Lake City Police Department

SLCPD Policy Manual

SLCPD Policy Manual

Automated License Plate Readers (ALPRs)

- (c) Review the alert information to determine the nature of the advisory.
- (d) In the event that compelling circumstances are present or situational officer safety issues make it unsafe to confirm the status of the alert information prior to taking action, the operator must confirm the status of the alert information as soon as possible.
- (e) When action is taken on an alert vehicle, it is the responsibility of the person taking action to provide the appropriate disposition information so the system may be updated as necessary.
- (f) Only sworn law enforcement officers should engage in contacting occupants of stolen or wanted vehicles.

426.5 LPR DATA COLLECTION, RETENTION AND ACCESS

LPR systems have the capacity to collect and store data relevant to and necessary for authorized law enforcement purposes. The Salt Lake City Police Department does not operate its own LPR server. All data collected by Salt Lake City Police LPR and LPR mobile systems are transferred to web-based servers. Vigilant Solutions and Flock are the Salt Lake City Police Department's contracted LPR systems maintenance partners. All data collected by Salt Lake City Police Department is accessible only to authorized Salt Lake City Police Department employees and authorized Law Enforcement partners.

- (a) In accordance with Utah State Law, 41-6a-2004, LPR data will be retained for a period of 9 months from the time the LPR record was captured by the LPR device.
- (b) Notwithstanding any other provision of law, all electronic images or data gathered by LPR technology are for the exclusive use of law enforcement personnel in the discharge of official duties and are not open to the public. (Utah Code 41-6a-2004)
- (c) Law enforcement officers shall not share LPR data with commercial or private entities or individuals. However, law enforcement officers may disseminate LPR data to government entities with authorized law enforcement or public safety purpose for access to such data. (Utah Code 41-6a-2003) LPR data is considered restricted information under Utah Code 41-6a-2004 and may not be released upon a GRAMA request.
- (d) Law enforcement officers shall not share or transfer data between LPR systems or databases.
- (e) Nothing in these guidelines should be interpreted as limiting the use of the electronic images or data for legitimate purposes by prosecutors or others legally permitted to receive evidence under the law.

426.6 LPR SYSTEM ADMINISTRATOR ROLE AND RESPONSIBILITIES

LPR System Administrators are identified as the Auto Theft Sergeant and any other designee assigned by the Investigations Division Commander.

LPR System Administrators are responsible for performing the following duties:

- (a) Ensuring personnel operating LPR systems and/or accessing LPR data have the technical expertise and necessary clearances to access law enforcement databases and information.

Salt Lake City Police Department

SLCPD Policy Manual

SLCPD Policy Manual

Automated License Plate Readers (ALPRs)

- (a) Updating operators of any technological, legal or other changes that affect the use of LPR systems.
- (a) Controlling LPR use, data access, and sharing of data with other authorized agencies.
- (a) Ensuring data from one LPR system is not shared, transferred, or otherwise given to another LPR system.
- (a) Serving as the primary point of contact for regional LPR issues and notification of system operational changes.
- (a) Developing and delivering training for LPR system use, including the initial training and any subsequent updates or revisions as necessary.
- (a) Overseeing placement of LPR cameras. All LPR camera placement requests should be sent to the Auto Theft Sergeant, who will approve or modify the request based on the needs of the department. The Auto Theft Sergeant will then notify the SLIC Sergeant who will be responsible for physically installing the LPR cameras.

426.7 ACCOUNTABILITY AND SAFEGUARDS

Audits of access to the data collected by the LPR system should be conducted by the Audit and Inspection Unit on a quarterly basis.

426.8 REVISIONS

Enacted: March 26, 2018

Revised: April 12, 2022

Homeless Persons

427.1 PURPOSE AND SCOPE

The purpose of this policy is to ensure that personnel understand the needs and rights of the homeless and to establish procedures to guide officers during all contacts with the homeless, whether consensual or for enforcement purposes. The Salt Lake City Police Department recognizes that members of the homeless community are often in need of special protection and services. The Salt Lake City Police Department will address these needs in balance with the overall missions of this department. Therefore, officers will consider the following when serving the homeless community.

427.1.1 POLICY

It is the policy of the Salt Lake City Police Department to provide law enforcement services to all members of the community while protecting the rights, dignity and private property of the homeless. Homelessness is not a crime and members of this department will not use homelessness solely as a basis for detention or law enforcement action.

427.2 HOMELESS COMMUNITY LIAISON

The Chief of Police will designate one or more members of this department to act as the Homeless Outreach Service Team (HOST) Officer(s). The responsibilities of the HOST Officer(s) include the following:

- (a) Maintain and make available to all department employees a list of assistance programs and other resources that are available to the homeless.
- (b) Meet with Social Services and representatives of other organizations that render assistance to the homeless.
- (c) Remain abreast of laws dealing with the removal and/or destruction of the personal property of the homeless.
- (d) Assist in coordinating, when possible, any clean-up operation conducted by the Health Department involving the removal of personal property of the homeless to ensure the rights of the homeless are not violated.

427.3 FIELD CONTACTS

Officers are encouraged to contact the homeless for purposes of rendering aid, support, and for community-oriented policing purposes. Nothing in this policy is meant to dissuade an officer from taking reasonable enforcement action when facts support a reasonable suspicion of criminal activity.

Officers will follow correct reporting procedures when handling calls involving homeless persons. [Salt Lake City Police Department Procedure Manual: 413.2 REPORTING PROCEDURES](#)

427.3.1 OTHER CONSIDERATIONS

Homeless members of the community will receive the same level and quality of service provided to other members of the community. The fact that a victim or witness is homeless can, however,

Salt Lake City Police Department

SLCPD Policy Manual

SLCPD Policy Manual

Homeless Persons

require special considerations for a successful investigation and prosecution. Officers should consider the following when handling investigations involving homeless victims, witnesses or suspects:

- (a) Document alternate contact information, such as email addresses. This may also include obtaining addresses and phone numbers of relatives and friends.
- (b) Document places the homeless person may frequent.
- (c) Provide homeless victims with victim/witness resources when appropriate.
- (d) Obtain statements from all available witnesses in the event a homeless victim is unavailable for a court appearance.
- (e) Consider whether the person may be a dependent adult or elder and if so proceed in accordance with the Adult Abuse Policy.

427.4 PERSONAL PROPERTY

Officers should use reasonable care when handling, collecting and retaining the personal property of homeless persons and should not destroy or discard any identifiable personal property of a homeless person.

When a homeless person is arrested, or otherwise removed from a public place, officers should make reasonable accommodations to permit the person to lawfully secure his/her personal property. Otherwise, the personal property should be collected for safekeeping.

Officers should not conduct or assist in clean-up operations of belongings that reasonably appear to be the property of homeless persons without the prior authorization of a supervisor or a department HOST Officer. When practicable, requests by the public for clean-up operations of a homeless encampment should be referred to a HOST Officer or the corresponding Community Intelligence Unit Detective for that area.

427.5 ECOLOGICAL ISSUES

Sometimes homeless encampments can impact the ecology and natural resources of the community and may involve criminal offenses beyond mere littering. Officers are encouraged to notify other appropriate agencies or departments when a significant impact to the environment has or is likely to occur. Significant impacts to the environment may warrant a crime report, investigation, supporting photographs and supervisor notification.

427.6 REVISIONS

Enacted: March 26, 2018

First Amendment Assemblies

428.1 PURPOSE AND SCOPE

This policy provides guidance for responding to public assemblies or demonstrations.

428.2 POLICY

The Salt Lake City Police Department respects the rights of people to peaceably assemble. It is the policy of this department not to unreasonably interfere with, harass, intimidate or discriminate against persons engaged in the lawful exercise of their rights, while also preserving the peace, protecting life and preventing the destruction of property.

428.3 GENERAL CONSIDERATIONS

Individuals or groups present on the public way, such as public facilities, streets or walkways, generally have the right to assemble, rally, demonstrate, protest or otherwise express their views and opinions through varying forms of communication, including the distribution of printed matter. These rights may be limited by laws or ordinances regulating such matters as the obstruction of individual or vehicle access or egress, trespass, noise, picketing, distribution of handbills and leafleting, and loitering. However, officers shall not take action or fail to take action based on the opinions being expressed.

Participant behavior during a demonstration or other public assembly can vary. This may include, but is not limited to:

- Lawful, constitutionally protected actions and speech.
- Civil disobedience (typically involving minor criminal acts).
- Rioting.

All of these behaviors may be present during the same event. Therefore, it is imperative that law enforcement actions are measured and appropriate for the behaviors officers may encounter. This is particularly critical if force is being used. Adaptable strategies and tactics are essential, including the use of the Public Order Unit and a Mobile Field Force. The purpose of a law enforcement presence at the scene of public assemblies and demonstrations should be to preserve the peace, to protect life and prevent the destruction of property.

Officers should not:

- (a) Engage in assembly or demonstration-related discussion with participants.
- (b) Harass, confront or intimidate participants.
- (c) Seize the cameras, cell phones or materials of participants or observers unless an officer is placing a person under lawful arrest.
- (d) Use unnecessary force on individuals or groups of people demonstrating/protesting.

Supervisors should continually observe department members under their commands to ensure that members' interaction with participants and their response to crowd dynamics is appropriate.

Salt Lake City Police Department

SLCPD Policy Manual

SLCPD Policy Manual

First Amendment Assemblies

428.3.1 PHOTOGRAPHS AND VIDEO RECORDINGS

Photographs and video recording, when appropriate, can serve a number of purposes, including support of criminal prosecutions by documenting criminal acts; assistance in evaluating department performance; serving as training material; recording the use of dispersal orders; and facilitating a response to allegations of improper law enforcement conduct.

Photographs and videos will not be used or retained for the sole purpose of collecting or maintaining information about the political, religious or social views of associations, or the activities of any individual, group, association, organization, corporation, business or partnership, unless such information directly relates to an investigation of criminal activities and there is reasonable suspicion that the subject of the information is involved in criminal conduct.

428.4 UNPLANNED EVENTS

When responding to an unplanned or spontaneous public gathering, the first responding officer should conduct an assessment of conditions, including, but not limited to, the following:

- Location
- Number of participants
- Apparent purpose of the event
- Leadership (whether it is apparent and/or whether it is effective)
- Any initial indicators of unlawful or disruptive activity
- Indicators that lawful use of public facilities, streets or walkways will be impacted
- Ability and/or need to continue monitoring the incident

Initial assessment information should be promptly communicated to Dispatch, and the assignment of a supervisor should be requested. Additional resources should be requested as appropriate. The responding supervisor shall assume command of the incident until command is expressly assumed by another, and the assumption of command is communicated to the involved members. A clearly defined command structure that is consistent with the Incident Command System (ICS) should be established as resources are deployed.

428.5 PLANNED EVENT PREPARATION

For planned events, comprehensive, incident-specific operational plans should be developed. The ICS should be considered for such events.

428.5.1 INFORMATION GATHERING AND ASSESSMENT

In order to properly assess the potential impact of a public assembly or demonstration on public safety and order, relevant information should be collected and vetted. This should include:

- Utilizing the Salt Lake Intelligence Center (SLIC) for building an assessment.
- Assessing social media outlets.
- Information obtained from outreach to group organizers or leaders.

Salt Lake City Police Department

SLCPD Policy Manual

SLCPD Policy Manual

First Amendment Assemblies

- Information about past and potential unlawful conduct associated with the event or similar events.
- The potential time, duration, scope and type of planned activities.
- Any other information related to the goal of providing a balanced response to criminal activity and the protection of public safety interests.

Information should be obtained in a transparent manner, and the sources documented. Relevant information should be communicated to the appropriate parties in a timely manner.

Information will be obtained in a lawful manner and will not be based solely on the purpose or content of the assembly or demonstration, or the race, ethnicity, national origin or religion of the participants (or any other characteristic that is unrelated to criminal conduct or the identification of a criminal subject).

428.5.2 OPERATIONAL PLANS

An operational planning team with responsibility for event planning and management should be established. The planning team should develop an operational plan for the event.

Depending on the size of the event, the operational plan may provide for:

- (a) Command assignments, chain of command structure, roles and responsibilities.
- (b) Staffing and resource allocation.
- (c) Management of criminal investigations.
- (d) Designation of uniform of the day and related safety equipment (e.g., helmets, shields).
- (e) Deployment of specialized resources.
- (f) Event communications and interoperability in a multijurisdictional event.
- (g) Liaison with demonstration leaders and external agencies.
- (h) Liaison with City government and legal staff.
- (i) Media relations.
- (j) Logistics: food, fuel, replacement equipment, duty hours, relief and transportation.
- (k) Traffic management plans.
- (l) First aid and emergency medical service provider availability.
- (m) Prisoner transport and detention.
- (n) Review of policies regarding public assemblies and use of force in crowd control.
- (o) Parameters for declaring an unlawful assembly.
- (p) Arrest protocol, including management of mass arrests.
- (q) Protocol for recording information flow and decisions.
- (r) Rules of engagement, including rules of conduct, protocols for field force extraction and arrests, and any authorization required for the use of force.

Salt Lake City Police Department

SLCPD Policy Manual

SLCPD Policy Manual

First Amendment Assemblies

- (s) Protocol for handling complaints during the event.
- (t) Parameters for the use of body-worn cameras and other portable recording devices.

428.5.3 MUTUAL AID AND EXTERNAL RESOURCES

The magnitude and anticipated duration of an event may necessitate interagency cooperation and coordination. The assigned Incident Commander should ensure that any required memorandums of understanding or other agreements are properly executed, and that any anticipated mutual aid is requested and facilitated (see the Outside Agency Assistance Policy).

428.6 UNLAWFUL ASSEMBLY DISPERSAL ORDERS

If a public gathering or demonstration remains peaceful and nonviolent, and there is no reasonably imminent threat to persons or property, the Incident Commander should generally authorize continued monitoring of the event.

Should the Incident Commander make a determination that public safety is presently or is about to be jeopardized, he/she or the authorized designee should attempt to verbally persuade event organizers or participants to disperse of their own accord. Warnings and advisements may be communicated through established communications links with leaders and/or participants or to the group.

When initial attempts at verbal persuasion are unsuccessful, the Incident Commander or the authorized designee should make a clear standardized announcement to the gathering that the event is an unlawful assembly, and should order the dispersal of the participants. The mobilization of a Mobile Field Force shall be in place prior to issuing a dispersal order (unless the Public Order Unit is already on scene). Furthermore, a call-out of the Public Order Unit shall also be initiated if not already done so.

[Salt Lake City Police Department Procedure Manual: 415.2 MOBILE FIELD FORCE](#)

[Salt Lake City Police Department Procedure Manual: 316.2 PUBLIC ORDER UNIT CALL-OUT](#)

The dispersal order should be communicated by whatever methods are reasonably available to ensure that the content of the message is clear and that it has been heard by the participants. The announcement should be amplified, made in different languages as appropriate, made from multiple locations in the affected area and documented by audio and video. The announcement should provide information about what law enforcement actions will take place if illegal behavior continues and should identify routes for egress. A reasonable time to disperse should be allowed following a dispersal order.

Example of Dispersal Order: “I am (name and rank) of the Salt Lake City Police Department. I hereby inform all persons in this assembly that you are in violation of (State Law or City Ordinance). I order you, in the name of the people of Salt Lake City, to leave. Failure to disperse will subject each of you to arrest and prosecution.”

Salt Lake City Police Department

SLCPD Policy Manual

SLCPD Policy Manual

First Amendment Assemblies

428.7 USE OF FORCE

Use of force is governed by current department policy and applicable law (see the Use of Force, Handcuffing and Restraints, Control Devices and Techniques, and Conducted Energy Device policies).

Individuals refusing to comply with lawful orders (e.g., nonviolent refusal to disperse) should be given a clear verbal warning and a reasonable opportunity to comply. If an individual refuses to comply with lawful orders, the Incident Commander shall evaluate the type of resistance and adopt a reasonable response in order to accomplish the law enforcement mission (such as dispersal or arrest of those acting in violation of the law).

Force or control devices, including oleoresin capsaicin (OC), should be directed toward individuals and not toward groups or crowds, unless specific individuals cannot reasonably be targeted due to extreme circumstances, such as a riotous crowd.

Any use of force by a member of this department shall be documented promptly, completely and accurately in an appropriate report. The type of report required may depend on the nature of the incident.

428.8 ARRESTS

The Salt Lake City Police Department should respond to unlawful behavior in a manner that is consistent with the operational plan. If practicable, warnings or advisements should be communicated prior to arrest.

Mass arrests should be employed only when alternate tactics and strategies have been, or reasonably appear likely to be, unsuccessful. Mass arrests shall only be undertaken upon the order of the Incident Commander or the authorized designee. There must be probable cause for each arrest.

If employed, mass arrest protocols should fully integrate:

- (a) Reasonable measures to address the safety of officers and arrestees.
- (b) Dedicated arrest teams and booking teams.
- (c) Timely access to medical care.
- (d) Timely processing of arrestees.
- (e) Full accountability for arrestees and evidence.

Moreover, proper Department mass arrests procedures shall be followed. [Salt Lake City Police Department Procedure Manual: 415.3 MASS ARRESTS PROCEDURE](#)

428.9 MEDIA RELATIONS

The Public Information Officer should use all available avenues of communication, including press releases, briefings, press conferences and social media to maintain open channels of communication with media representatives and the public about the status and progress of the

Salt Lake City Police Department

SLCPD Policy Manual

SLCPD Policy Manual

First Amendment Assemblies

event, taking all opportunities to reassure the public about the professional management of the event (see the Media Relations Policy).

428.10 DEMOBILIZATION

When appropriate, the Incident Commander or the authorized designee should implement a phased and orderly withdrawal of law enforcement resources. All relieved personnel should promptly complete any required reports, including use of force reports, and account for all issued equipment and vehicles to their supervisors prior to returning to normal operational duties.

428.11 POST EVENT

The Incident Commander should designate a member to assemble full documentation of the event, to include the following:

- (a) Operational plan
- (b) Any incident logs
- (c) Any assignment logs
- (d) Vehicle, fuel, equipment and supply records
- (e) Incident, arrest, use of force, injury and property damage reports
- (f) Photographs, audio/video recordings, Dispatch records/tapes
- (g) Media accounts (print and broadcast media)

428.11.1 AFTER-ACTION REPORTING

The Incident Commander should work with City legal counsel, as appropriate, to prepare a comprehensive after-action report of the event, explaining all incidents where force was used including the following:

- (a) Date, time and description of the event
- (b) Actions taken and outcomes (e.g., injuries, property damage, arrests)
- (c) Problems identified
- (d) Significant events
- (e) Recommendations for improvement; opportunities for training should be documented in a generic manner, without identifying individuals or specific incidents, facts or circumstances.

428.12 TRAINING

Department members should receive periodic training regarding this policy, as well as the dynamics of crowd control and incident management.

428.13 REVISIONS

Enacted: March 26, 2018

Suspicious Activity Reporting

429.1 PURPOSE AND SCOPE

This policy provides guidelines for reporting and investigating suspicious activity.

429.1.1 DEFINITIONS

Definitions related to this policy include:

Involved party - An individual who has been observed engaging in suspicious activity, as defined in this policy, when no definitive criminal activity can be identified, thus precluding the person's identification as a suspect.

Suspicious activity - Any reported or observed activity that a member reasonably believes may have a nexus to any criminal act or attempted criminal act, or to foreign or domestic terrorism. Examples of suspicious activity may include, but are not limited to:

- Suspected pre-operational surveillance or intelligence gathering (e.g., photographing security features, asking questions about sensitive security-related subjects).
- Tests of security measures and response to incidents (e.g., "dry run," creating false alarms, attempts to enter secure areas without authorization).
- Suspicious purchases (e.g., purchasing large quantities of otherwise legal items, such as fertilizer, that could be used to create an explosive or other dangerous device).
- An individual in possession of such things as a hoax explosive or dispersal device, sensitive materials (e.g., passwords, access codes, classified government information), or coded or ciphered literature or correspondence.

Suspicious Activity Report (SAR) - An incident report used to document suspicious activity (using the NCIC code 5399-28).

429.2 POLICY

The Salt Lake City Police Department recognizes the need to protect the public from criminal conduct and acts of terrorism and shall lawfully collect, maintain and disseminate information regarding suspicious activities, while safeguarding civil liberties and privacy protections.

429.3 RESPONSIBILITIES

The Salt Lake Information Center (SLIC), the Investigation Division Commander, and authorized designees will manage SAR activities. Authorized designees should include supervisors who are responsible for department participation in criminal intelligence systems as outlined in the Criminal Organizations Policy.

The responsibilities of the Investigation Division Commander and SLIC include, but are not limited to:

- (a) Remaining familiar with those databases available to the Department that would facilitate the purpose of this policy.

Salt Lake City Police Department

SLCPD Policy Manual

SLCPD Policy Manual

Suspicious Activity Reporting

- (b) Maintaining adequate training in the area of intelligence gathering to ensure no information is being maintained that would violate the law or civil rights of any individual.
- (c) Ensuring a process is available that would allow members to report relevant information. The process should be designed to promote efficient and quick reporting, and should not be cumbersome, duplicative or complicated.
- (d) Ensuring that members are made aware of the purpose and value of documenting information regarding suspicious activity, as well as the databases and other information resources that are available to the Department.
- (e) Ensuring that SAR information is appropriately disseminated to members in accordance with their job responsibilities.
- (f) Coordinating investigative follow-up, if appropriate.
- (g) Coordinating with any appropriate agency or fusion center.
- (h) Ensuring that, as resources are available, the Department conducts outreach that is designed to encourage members of the community to report suspicious activity and that outlines what they should look for and how they should report it (e.g., website, public service announcements, Community Intelligence Unit).

429.4 REPORTING AND INVESTIGATION

Any department member receiving information regarding suspicious activity should take any necessary immediate and appropriate action, including a request for tactical response or immediate notification of specialized entities, when applicable. Any non-sworn member who receives such information should ensure that it is passed on to an officer in a timely manner.

If the suspicious activity is not directly related to a reportable crime, the member should prepare a SAR and include information about involved parties and the circumstances of the incident. If, during any investigation, an officer becomes aware of suspicious activity that is unrelated to the current investigation, the information should be documented separately in a SAR and not included in the original incident report. The report number of the original incident should be included in the SAR as a cross reference. A SAR should be processed as any other incident report.

429.5 HANDLING INFORMATION

The Records Section will forward copies of SARs, in a timely manner, to the following:

- Robbery supervisor
- The Salt Lake Information Center (SLIC)
 - The SLIC will be responsible for forwarding SARs on to the Statewide Information & Analysis Center (SIAC)
- Other authorized designees

429.6 REVISIONS

Enacted: March 26, 2018

Civil Disputes

430.1 PURPOSE AND SCOPE

This policy provides members of the Salt Lake City Police Department with guidance for addressing conflicts between persons when no criminal investigation or enforcement action is warranted (e.g., civil matters), with the goal of minimizing any potential for violence or criminal acts.

The Domestic Violence Policy will address specific legal mandates related to domestic violence court orders and child custody orders. References in this policy to “court orders” apply to any order of a court that does not require arrest or enforcement by the terms of the order or by Utah law.

430.2 POLICY

The Salt Lake City Police Department recognizes that a law enforcement presence at a civil dispute can play an important role in the peace and safety of the community. Subject to available resources, members of this department may assist at the scene of civil disputes with the primary goal of safeguarding persons and property, preventing criminal activity and maintaining the peace. When handling civil disputes, members will remain impartial, give consideration to all sides, and refrain from giving legal advice.

430.3 GENERAL CONSIDERATIONS

When appropriate, members handling a civil dispute should encourage the involved parties to seek the assistance of resolution services or take the matter to the civil courts. Members must not become personally involved in disputes and shall at all times remain impartial.

While not intended to be an exhaustive list, members should give considerations to the following when handling civil disputes:

- (a) Civil disputes tend to be confrontational and members should be alert that they can escalate to violence very quickly.
- (b) Members shall not provide legal advice, however, when appropriate, members should inform the parties when they are at risk of violating criminal laws.
- (c) Members are reminded that they shall not enter a residence or other non-public location without legal authority including valid consent.

430.4 COURT ORDERS

Disputes involving court orders can be complex. Where no mandate exists for an officer to make an arrest for a violation of a court order, the matter should be addressed by documenting any apparent court order violation in a report. If there is a question regarding the need for enforcement action, the investigating officer should consult a supervisor prior to making any arrest.

If a person appears to be violating the terms of a court order but is disputing the validity of the order or its applicability, the investigating officer should document the following:

- (a) The person’s knowledge of the court order or whether proof of service exists.

Salt Lake City Police Department

SLCPD Policy Manual

SLCPD Policy Manual

Civil Disputes

- (b) Any specific reason or rationale the involved person offers for not complying with the terms of the order.

A copy of the court order should be attached to the report when available.

430.4.1 STANDBY ASSISTS

Officers responding to a call for standby assistance to retrieve property should meet the person requesting assistance at a neutral location to discuss the process. The person should be advised that items that are disputed will not be allowed to be removed. The member may advise the person to seek private legal advice as to the distribution of disputed property.

Members should accompany the person to the location of the property.

If the other party is uncooperative, the person requesting standby assistance should be instructed to seek private legal advice and obtain a court order to obtain the items. Officers should not order the other party to allow entry or the removal of any items.

If the other party is not present at the location, officers will advise the person requesting assistance that they may contact police at another time.

430.5 STANDBY REQUESTS FOR VEHICLES AND PERSONAL PROPERTY

Officers may be faced with disputes regarding possession or ownership of vehicles or other personal property. Officers may review documents provided by parties or available databases (e.g., vehicle registration), but should be aware that legal possession of vehicles or personal property can be complex. Generally, officers should not take any enforcement action unless a crime is apparent. The people and the vehicle or personal property involved should be identified and the incident documented.

430.5.1 VEHICLE REPOSSESSIONS

The Utah Uniform Commercial Code provides that a secured party has the right to take possession of the collateral upon default. This is known as self-help. Self-help is defined as a secured party (creditor) proceeding without judicial process.

This must be accomplished without a breach of the peace, or a violation of other laws. A breach of the peace occurs when the repossession continues in the face of circumstances provocative of violence or the potential for violence.

Creditors will be advised the Department will not provide a police officer in a self-help situation. The mere presence of an armed and uniformed officer who says and does nothing may be construed as intimidating and misinterpreted.

Unless the creditor has a court order from the person possessing the property, officers should not be present. If the officers' presence is necessary to preserve the peace, the officers should require the parties to obtain a court order. Without a court order, an officer cannot authorize removal of the vehicle over the objections of the person in possession of the vehicle. If the person in possession of the vehicle objects to removal of the vehicle, the wrecker driver will not be allowed to remove the vehicle, but will be advised to pursue civil processes to recover the vehicle. If the wrecker driver

Salt Lake City Police Department

SLCPD Policy Manual

SLCPD Policy Manual

Civil Disputes

has obtained possession of the vehicle and removed it from the property where it was parked, the officer will not require the return of the vehicle to the presumed owner. The presumed owner will have to obtain a court order to re-obtain possession of the vehicle.

430.5.2 TOWING COMPANY REPORTS OF REPOSSESSIONS

Towing companies will call the Records Unit to report all vehicle repossessions as soon as possible. The following information is needed for entry into the RMS:

- (a) Vehicle description.
- (b) Address the vehicle was taken from.
- (c) Wrecker company name and phone number.
- (d) Storage location.
- (e) Institution repossessing the vehicle with a contact person's name and phone number.

An owner of a repossessed vehicle wanting to report the vehicle stolen will be advised to contact the institution responsible for the repossession at the phone number provided.

430.6 REAL PROPERTY

Disputes over possession or occupancy of real property (e.g., land, homes, apartments) should generally be handled through a person seeking a court order.

430.6.1 LONG-TERM GUEST ISSUES

For disputes related to a long-term guest, as defined by Utah Code 76-6-206.4, who has received notice to vacate a residence by the primary occupant or other person with apparent authority to act for the primary occupant, officers must provide the guest with a reasonable time to collect personal belongings prior to escorting the individual from the residence (Utah Code 76-6-206.4).

430.7 MECHANICS LIENS

Various persons who furnish materials or work are entitled to a mechanic's lien. If a person is claiming a mechanic's lien, the officer should notify the parties that it is a civil matter and will require a court order to change the status quo. Officers are only to preserve the peace.

A mechanic's lien does not require a court order as long as the property is in the possession of the person claiming the lien. If the person claiming the lien has lost possession of the property, they must obtain a court order to enforce their claim.

430.8 MISCELLANEOUS LIENS

Miscellaneous liens exist for livestock, innkeepers, repairmen, etc. These situations are to be handled the same as situations involving a mechanic's lien. A miscellaneous lien does not require a court order as long as the property is in possession of the person claiming the lien. If the person claiming the lien has lost possession of the property, they must obtain a court order to enforce their claim.

Salt Lake City Police Department

SLCPD Policy Manual

SLCPD Policy Manual

Civil Disputes

430.9 REVISIONS

Enacted: March 26, 2018

Crisis Intervention Incidents

431.1 PURPOSE AND SCOPE

This policy provides guidelines for interacting with those who may be experiencing a mental health or emotional crisis. Interaction with such individuals has the potential for miscommunication and violence. It often requires an officer to make difficult judgments about a person's mental state and intent in order to effectively and legally interact with the individual.

431.1.1 DEFINITIONS

Definitions related to this policy include:

Person in crisis - A person whose level of distress or mental health symptoms have exceeded the person's internal ability to manage his/her behavior or emotions. A crisis can be precipitated by any number of things, including an increase in the symptoms of mental illness despite treatment compliance; non-compliance with treatment, including a failure to take prescribed medications appropriately; or any other circumstance or event that causes the person to engage in erratic, disruptive or dangerous behavior that may be accompanied by impaired judgment.

Crisis Intervention Team (CIT) - CIT officers have received specialized training on how to respond to persons experiencing a mental health crisis. CIT officers are certified by the Department.

431.2 POLICY

The Salt Lake City Police Department is committed to providing a consistently high level of service to all members of the community and recognizes that persons in crisis may benefit from intervention. The Department will collaborate, where feasible, with mental health professionals to develop an overall intervention strategy to guide its members' interactions with those experiencing a mental health crisis. This is to ensure equitable and safe treatment of all involved.

Proper dispatching and officer response procedures will be followed when responding to crisis intervention incidents. [Salt Lake City Police Department Procedure Manual: 412.2 DISPATCH AND OFFICER RESPONSE PROCEDURES](#)

431.3 SIGNS

Members should be alert to any of the following possible signs of mental health issues or crises:

- (a) A known history of mental illness
- (b) Threats of or attempted suicide
- (c) Loss of memory
- (d) Incoherence, disorientation or slow response
- (e) Delusions, hallucinations, perceptions unrelated to reality or grandiose ideas
- (f) Depression, pronounced feelings of hopelessness or uselessness, extreme sadness or guilt

Salt Lake City Police Department

SLCPD Policy Manual

SLCPD Policy Manual

Crisis Intervention Incidents

- (g) Social withdrawal
- (h) Manic or impulsive behavior, extreme agitation, lack of control
- (i) Lack of fear
- (j) Anxiety, aggression, rigidity, inflexibility or paranoia

Members should be aware that this list is not exhaustive. The presence or absence of any of these should not be treated as proof of the presence or absence of a mental health issue or crisis.

431.4 COORDINATION WITH MENTAL HEALTH PROFESSIONALS

The Chief of Police should designate an appropriate CIT Investigative Unit Sergeant to collaborate with mental health professionals to develop an education and response protocol. It should include a list of community resources, to guide department interaction with those who may be suffering from mental illness or who appear to be in a mental health crisis.

431.5 FIRST RESPONDERS

Safety is a priority for first responders. It is important to recognize that individuals under the influence of alcohol, drugs or both may exhibit symptoms that are similar to those of a person in a mental health crisis. These individuals may still present a serious threat to officers; such a threat should be addressed with reasonable tactics. Nothing in this policy shall be construed to limit an officer's authority to use reasonable force when interacting with a person in crisis.

Officers are reminded that mental health issues, mental health crises and unusual behavior alone are not criminal offenses. Individuals may benefit from treatment as opposed to incarceration.

An officer responding to a call involving a person in crisis should:

- (a) Promptly assess the situation independent of reported information and make a preliminary determination regarding whether a mental health crisis may be a factor.
- (b) Attempt to determine if weapons are present or available.
- (c) Take into account the person's mental and emotional state and potential inability to understand commands or to appreciate the consequences of his/her action or inaction, as perceived by the officer.
- (d) Secure the scene and clear the immediate area as necessary.
- (e) Employ tactics to preserve the safety of all participants.
- (f) Determine the nature of any crime.
- (g) If circumstances reasonably permit, consider and employ alternatives to force.

431.5.1 MOBILE CRISIS OUTREACH TEAM (MCOT)

MCOT's are teams consisting of a Mental Health Designated Examiner and a Certified Peer Specialist. These teams can take over crisis intervention incidents once it is deemed safe to do so. Officers requesting an MCOT response will follow the proper procedure for doing so.

[Salt Lake City Police Department Procedure Manual: 412.3 MCOT RESPONSE PROCEDURE](#)

Salt Lake City Police Department

SLCPD Policy Manual

SLCPD Policy Manual

Crisis Intervention Incidents

431.6 GENERAL CONSIDERATIONS

Officers should consider that taking no action or passively monitoring the situation may be the most reasonable response to a mental health crisis.

Once it is determined that a situation is a mental health crisis and immediate safety concerns have been addressed, responding members should be aware of the following considerations and should generally:

- Evaluate safety conditions.
- Introduce themselves and attempt to obtain the person's name.
- Be patient, polite, calm, and courteous.
- Speak and move slowly and in a non-threatening manner.
- Moderate the level of direct eye contact.
- Remove distractions or disruptive people from the area.
- Demonstrate active listening skills (e.g., summarize the person's verbal communication).
- Provide for sufficient avenues of retreat or escape should the situation become volatile.

431.7 INTERVIEWS AND INTERROGATIONS

When conducting an interview and/or interrogation with an individual who is experiencing a mental health crisis, officers should keep the following in mind:

- (a) The subject's state of mind and ability to answer the officer's questions appropriately.
- (b) Officers should refrain from tactics meant to confuse the subject.
- (c) Officers need to take care to ensure that the waiver of *Miranda* rights, when applicable, is knowingly, intelligently, and voluntary.

431.8 SUPERVISOR RESPONSIBILITIES

Responding supervisors should:

- (a) Attempt to secure appropriate and sufficient resources.
- (b) Monitor the use of force, including the use of restraints, and ensure that those subjected to the use of force are provided with timely access to medical care (see the Handcuffing and Restraints Policy).
- (c) Consider strategic disengagement. Absent an imminent threat to the public and, as circumstances dictate, this may include removing or reducing law enforcement resources or engaging in passive monitoring.
- (d) Ensure that all reports are completed and that incident documentation uses appropriate terminology and language.

Salt Lake City Police Department

SLCPD Policy Manual

SLCPD Policy Manual

Crisis Intervention Incidents

431.9 INCIDENT REPORTING

Members engaging in any oral or written communication associated with a mental health crisis should be mindful of the sensitive nature of such communications and should exercise appropriate discretion when referring to or describing persons and circumstances. When documenting interactions with individuals experiencing a mental health crisis, officers should focus on describing behaviors and avoid attempting to make diagnoses.

Members having contact with a person in crisis should keep related information confidential, except to the extent that revealing information is necessary to conform to department reporting procedures or other official mental health or medical proceedings.

When preparing reports regarding crisis intervention incidents, proper reporting procedures will be followed. [Salt Lake City Police Department Procedure Manual: 412.4 CIT REPORT WRITING PROCEDURES](#)

431.9.1 DIVERSION

Individuals who are not being arrested should be processed in accordance with the Civil Commitments Policy.

431.10 NON-SWORN INTERACTION WITH PEOPLE IN CRISIS

Non-sworn members may be required to interact with persons in crisis in an administrative capacity, such as dispatching, records request, etc.

- (a) Members should treat all individuals equally and with dignity and respect.
- (b) If a member believes that he/she is interacting with a person in crisis, he/she should proceed patiently and in a calm manner.
- (c) Members should be aware and understand that the person may make unusual or bizarre claims or requests.
- (d) If the individual continues to return on a regular basis, members may refer the person to the CIT Investigative Unit.

If a person's behavior makes the member feel unsafe, if the person is or becomes disruptive or violent, or if the person acts in such a manner as to cause the member to believe that the person may be harmful to him/herself or others, an officer should be promptly summoned to provide assistance.

431.11 TRAINING

In coordination with the mental health community and appropriate stakeholders, the Department will provide entry level education and training to all department members, as well as annual refresher training, to enable them to effectively interact with persons in crisis.

431.11.1 CIT CERTIFICATION

The Salt Lake City Police Department has three tiers of CIT certification for its sworn personnel:

- I. Tier 1 - It is the policy of this department that all sworn personnel will attend and successfully complete the 40-hour CIT academy. The Department provides the CIT

Salt Lake City Police Department

SLCPD Policy Manual

SLCPD Policy Manual

Crisis Intervention Incidents

academy to all newly hired officers, and is presently working towards having any sworn personnel who have not already attended the CIT academy do so.

- II. Tier II (Active CIT Officers) - These are CIT certified officers that retain active CIT certification by annually attending, voluntarily, 4 hours of CIT-related training. To assist officers in retaining their certification, once a year, the department will provide a 4-hour recertification class that reviews applicable case law, as well as mental health system and resources updates.
- III. Tier III (CIT Instructors) - These are officers that are are CIT instructors who attend additional annual training beyond Tier II officers.

431.12 REVISIONS

Enacted: March 26, 2018

Revised: December 17, 2018

Medical Aid and Response

432.1 PURPOSE AND SCOPE

This policy recognizes that members often encounter persons in need of medical aid and establishes a law enforcement response to such situations.

432.2 POLICY

It is the policy of the Salt Lake City Police Department that all officers and other designated members facilitate an emergency medical response.

432.3 FIRST RESPONDING MEMBER RESPONSIBILITIES

When needed, members should contact Dispatch and request response by emergency medical services (EMS).

Members should follow universal precautions when interacting with individuals in need of medical aid, such as wearing gloves and avoiding contact with bodily fluids, consistent with the Communicable Diseases Policy.

When requesting EMS, the member should provide Dispatch with information for relay to EMS personnel in order to enable an appropriate response, including:

- (a) The location where EMS is needed.
- (b) The nature of the incident.
- (c) Any known scene hazards.
- (d) Information on the person in need of EMS, such as:
 1. Signs and symptoms as observed by the member.
 2. Changes in apparent condition.
 3. Number of patients, sex and age, if known.
 4. Whether the person is conscious, breathing and alert, or is believed to have consumed drugs or alcohol.
 5. Whether the person is showing signs or symptoms of excited delirium or other agitated chaotic behavior.

Members should stabilize the scene whenever practicable while awaiting the arrival of EMS and should inform dispatch when the scene is clear for EMS.

Members should not direct EMS personnel whether to transport the person for treatment.

432.4 TRANSPORTING ILL AND INJURED PERSONS

Except in extraordinary cases where alternatives are not reasonably available, members should not transport persons who are unconscious, who have serious injuries or who may be seriously ill. EMS personnel should be called to handle patient transportation.

Salt Lake City Police Department

SLCPD Policy Manual

SLCPD Policy Manual

Medical Aid and Response

Officers should search any person who is in custody before releasing that person to EMS for transport.

An officer should accompany any person in custody during transport in an ambulance when requested by EMS personnel, when it reasonably appears necessary to provide security, when it is necessary for investigative purposes or when so directed by a supervisor.

Members should not provide emergency escort for medical transport or civilian vehicles.

432.5 PERSONS REFUSING EMS CARE

If a person who is not in custody refuses EMS care or refuses to be transported to a medical facility, an officer shall not force that person to receive care or be transported. However, members may assist EMS personnel when EMS personnel determine the person lacks mental capacity to understand the consequences of refusing medical care or to make an informed decision and the lack of immediate medical attention may result in serious bodily injury or the death of the person.

In cases where mental illness may be a factor, the officer should consider proceeding with temporary custody pursuant to a civil commitment in accordance with the Civil Commitments Policy.

If an officer believes that a person who is in custody requires EMS care and the person refuses, he/she should request that EMS respond and assess the person in custody's medical needs. If the individual under assessment is determined by EMS as needing medical assistance, then the individual may be transported.

If the person still refuses, the officer will require the person to be transported to the nearest medical facility. In such cases, the officer should notify the supervisor of the transport.

Members shall not sign refusal-for-treatment forms or forms accepting financial responsibility for treatment.

432.5.1 SICK OR INJURED ARRESTEE

If an arrestee appears ill or injured, or claims illness or injury, he/she should be medically cleared prior to booking.

If the jail or detention facility refuses to accept custody of an arrestee based on medical screening, the officer should note the name of the facility person refusing to accept custody and the reason for refusal, and should notify a supervisor to determine the appropriate action.

Arrestees who appear to have a serious medical issue should be transported by ambulance.

432.6 MEDICAL ATTENTION RELATED TO USE OF FORCE

Specific guidelines for medical attention for injuries sustained from a use of force may be found in the Use of Force, Handcuffing and Restraints, Control Devices and Techniques, and Conducted Energy Device policies.

Salt Lake City Police Department

SLCPD Policy Manual

SLCPD Policy Manual

Medical Aid and Response

432.7 AIR AMBULANCE

Generally, when on-scene, EMS personnel will be responsible for determining whether an air ambulance response should be requested. An air ambulance may be appropriate when there are victims with life-threatening injuries or who require specialized treatment (e.g., gunshot wounds, burns, obstetrical cases), and distance or other known delays will affect the EMS response.

When choosing a landing zone for an air ambulance the member should identify:

- Responsibility and authority for designating a landing zone and determining the size of the landing zone.
- Responsibility for securing the area and maintaining that security once the landing zone is identified.
- Consideration of the air ambulance provider's minimum standards for proximity to vertical obstructions and surface composition (e.g., dirt, gravel, pavement, concrete, grass).
- Consideration of the air ambulance provider's minimum standards for horizontal clearance from structures, fences, power poles, antennas or roadways.
- Responsibility for notifying the appropriate highway or transportation agencies if a roadway is selected as a landing zone.
- Procedures for ground personnel to communicate with flight personnel during the operation.

One department member at the scene should be designated as the air ambulance communications contact. Headlights, spotlights and flashlights should not be aimed upward at the air ambulance. Members should direct vehicle and pedestrian traffic away from the landing zone.

Members should follow these cautions when near an air ambulance:

- Never approach the aircraft until signaled by the flight crew.
- Always approach the aircraft from the side.
- Avoid the aircraft's tail rotor area.
- Wear eye protection during landing and take-off.
- Do not carry or hold items, such as IV bags, above the head.
- Ensure that no one smokes near the aircraft.

While EMS personnel are the ones who typically request an air ambulance response, there are times when department members may need to make such a request. When requesting and/or arranging a landing zone for an air ambulance, members will follow proper procedures. [Salt Lake City Police Department Procedure Manual: 414.2 REQUESTING AN AIR AMBULANCE AND PREPARING A LANDING ZONE](#)

Salt Lake City Police Department

SLCPD Policy Manual

SLCPD Policy Manual

Medical Aid and Response

432.8 ADMINISTRATION OF OPIOID OVERDOSE MEDICATION

Members may administer opioid overdose medication in accordance with protocol specified by the health care provider who prescribed the overdose medication for use by the member (Utah Code 26-55-104).

432.8.1 OPIOID OVERDOSE MEDICATION USER RESPONSIBILITIES

Members who are qualified to administer opioid overdose medication, such as naloxone, should handle, store and administer the medication consistent with their training. Members should periodically check their issued medication and associated administration equipment to ensure they are serviceable and not expired. Any expired medication or unserviceable administration equipment should be removed from service.

Any member who administers an opioid overdose medication should contact Dispatch as soon as possible and request response by EMS. A member who administers an opioid overdose medication will remain with the patient until care is transferred to EMS personnel.

432.8.2 OPIOID OVERDOSE MEDICATION REPORTING AND REPLACEMENT

Any member administering opioid overdose medication shall detail its use in an appropriate report.

After administering opioid overdose medication, the member will follow proper procedure for supply replacement. [Salt Lake City Police Department Procedure Manual: 414.3 OPIOID OVERDOSE MEDICATION REPLACEMENT](#)

432.8.3 OPIOID OVERDOSE MEDICATION TRAINING

The Training Lieutenant should ensure training is provided to members authorized to administer opioid overdose medication. The training should include the written instructions provided by the dispensing health care provider on (Utah Code 26-55-104):

- (a) How to recognize an opiate-related drug overdose event.
- (b) How to administer an opiate antagonist.
- (c) How to ensure that an individual to who the medication has been administered receives additional medical care and a medical evaluation, as soon as possible.

432.9 REVISIONS

Enacted: March 26, 2018

Chapter 5 - Traffic Operations

Traffic Function and Responsibility

500.1 PURPOSE AND SCOPE

The ultimate goal of traffic enforcement is to reduce traffic-related collisions. This may be achieved through the application of geographic/problem-based assignment and preventive patrol. Traffic enforcement techniques can be based on accident data, enforcement activity records, traffic volume and traffic conditions. This department provides enforcement efforts toward violations, not only in proportion to the frequency of their occurrence in accident situations, but also in terms of traffic-related needs.

500.2 TRAFFIC OFFICER DEPLOYMENT

Several factors are considered in the development of deployment schedules for officers of the Salt Lake City Police Department. Information provided by the City Transportation Division and the Utah Department of Public Safety's Highway Safety Office is a valuable resource for traffic accident occurrences and therefore officer deployment. Some of the factors for analysis include:

- Location
- Time
- Day
- Violation factors

All officers assigned to patrol or traffic enforcement functions are encouraged to take action when violations of traffic law are observed. Members of the Department assigned to the Motor Squad will have the primary responsibility to conduct directed enforcement, as well as random enforcement, as a matter of routine.

Other factors to be considered for deployment are personal knowledge of hazardous locations, school zones, citizen requests, construction zones, or special events occurring in the city.

500.2.1 TEMPORARY TRAFFIC CONTROL DEVICES

In certain situations, it may be prudent for an officer to deploy temporary traffic control devices such as cones, flares (traditional or electronic), or barricades. Officers are to use their discretion in conjunction with the circumstances of the situation to determine how best to deploy these devices. If barricades are needed, officers will contact their supervisor with the request. If approved, the supervisor or requesting officer will direct the service channel dispatcher to contact the Department's contracted barricade company for a response to the corresponding address.

500.3 ENFORCEMENT

Enforcement actions are commensurate with applicable laws and take into account the degree and severity of the violation(s) committed. During a member's regular duties they are encouraged to uniformly enforce violations of applicable traffic law that apply to the following situations:

- Observed moving violations

Salt Lake City Police Department

SLCPD Policy Manual

SLCPD Policy Manual

Traffic Function and Responsibility

- Observed non-moving violations
- Violations that involves public carriers, commercial vehicles, pedestrians, or bicycles
- Newly enacted laws and/or regulations
- Multiple violations
- Any appropriate enhancements that may be applied

Officers should remember that any enforcement taken should be done with the goal of encouraging voluntary compliance with traffic laws and regulations. This department does not establish ticket quotas.

500.3.1 WARNINGS

Warnings are both valid and effective enforcement actions and should be considered in each situation.

500.3.2 CITATIONS

Citations may be issued when an officer believes it is appropriate. It is essential that officers fully explain the rights and requirements imposed on motorists upon issuance of a citation for a traffic violation. Officers should provide the following information at a minimum:

- (a) Explanation of the violation or charge.
- (b) The court appearance procedure, including the optional or mandatory appearance by the motorist.
- (c) Notice of whether the motorist can enter a plea and pay the fine online, by mail, or at the court.
- (d) Any other information that must be provided to the motorist prior to release.

500.3.3 PHYSICAL ARREST

A physical arrest can be made on a number of criminal traffic offenses outlined in Utah Code Title 41. These physical arrest cases usually deal with, but are not limited to:

- (a) Vehicular manslaughter.
- (b) Felony and misdemeanor driving under the influence of alcohol/drugs.
- (c) Felony or misdemeanor hit-and-run (Utah Code 41-6a-401.3).
- (d) Fleeing in a vehicle.
- (e) Possession of a stolen vehicle.

500.4 SUSPENDED OR REVOKED DRIVER'S LICENSES

If an officer comes into contact with a traffic violator who is driving on a suspended or revoked license, the officer should issue a traffic citation pursuant to Utah Code 53-3-227. Regardless of the issuance of a citation, the violator shall not be permitted to continue operating a motor vehicle. The circumstances surrounding the suspension or revocation should be considered in regard to

Salt Lake City Police Department

SLCPD Policy Manual

SLCPD Policy Manual

Traffic Function and Responsibility

the disposition of the violator's vehicle (i.e., whether the vehicle is impounded, operated by another licensed driver, or secured at the location of contact with the owner's permission).

500.5 HIGH-VISIBILITY VESTS

The Department has provided American National Standards Institute (ANSI) Class II high-visibility vests to increase the visibility of department members who may be exposed to hazards presented by passing traffic (23 CFR 655.601).

Members working in traffic, day or night, are required to wear the department issued fluorescent safety vest. Although intended primarily for use while performing traffic related assignments, high-visibility vests should be worn any time increased visibility would improve the safety or efficiency of the member.

500.5.1 REQUIRED USE

Except when working in a potentially adversarial or confrontational role, such as during vehicle stops, high-visibility vests should be worn at any time it is anticipated that an employee will be exposed to the hazards of approaching traffic or construction and recovery equipment. Examples of when high-visibility vests should be worn include traffic control duties, accident investigations, lane closures and while at disaster scenes, or anytime high visibility is desirable. When emergency conditions preclude the immediate donning of the vest, officers should retrieve and wear the vest as soon as conditions reasonably permit.

500.5.2 CARE AND STORAGE OF HIGH-VISIBILITY VESTS

High-visibility vests shall be kept readily available. Members should take care in the manner with which they store each vest so as to protect and maintain the vest in a serviceable condition.

Replacement vests will be maintained by the Quartermaster and available upon request.

500.6 SPEEDING IN A SCHOOL ZONE COMPLAINT PROCEDURE

It is the responsibility of the Special Event/Motor Lieutenant to establish a report form and a procedure for school crossing guards to report speed violations to the Salt Lake City Police Department. The reporting forms shall be made available to school crossing guards and to school administrative offices (Utah Code 41-6a-604 and Utah Code 41-6a-604.5). The report form shall include the following:

- (a) Date, time and location of the violation.
- (b) Vehicle license plate number and state.
- (c) Vehicle description.
- (d) Description of the vehicle operator.
- (e) Description of the incident.
- (f) Contact information of the school crossing guard.
- (g) The signature of the school crossing guard who witnessed the offense attesting to the accuracy of the report.

Salt Lake City Police Department

SLCPD Policy Manual

SLCPD Policy Manual

Traffic Function and Responsibility

Reports should be submitted to the Salt Lake City Police Department no more than two business days after the alleged violation occurred.

500.6.1 NOTIFICATION OF VIOLATION TO VIOLATOR/VEHICLE OWNER

It will be the Special Event/Motor Lieutenant's responsibility to establish a system in which notification letters are sent to the last known registered owner of the vehicle that was reported speeding. The letter should contain the following (Utah Code 41-6a-604.5(1)(a)):

- (a) Applicable information on the school crossing guard's report stating that the vehicle was observed speeding in a reduced-speed school zone in violation of state law.
- (b) Complete explanation of the applicable provisions of Utah Code 41-6a-604.
- (c) An explanation that the notification letter is not a peace officer citation but is an effort to call attention to the seriousness of the incident.

The Special Event/Motor Lieutenant is responsible for ensuring all other mandates of Utah Code 41-6a-604.5 are met or that further investigation, if warranted, is conducted.

500.7 POLICE ESCORTS FOR PHYSICIANS

If an officer conducts a traffic stop on a physician and the physician claims that there is an extreme medical emergency, the officer should obtain identification, the nature of the emergency, and the intended destination from the physician. The officer should assist the physician to the destination. An escort should be considered as a last resort because of the potential hazards involved. It is suggested that the officer transport the physician in the police vehicle if possible. The officer will notify the dispatcher of the emergency run.

Upon arrival at the destination, the officer will verify that the driver is a physician and that the emergency was extreme. The officer should take appropriate enforcement action at that time if needed.

500.8 HAZARDOUS ROADWAY CONDITIONS

Roadway and roadside hazards are often times one of the contributing factors for many traffic collisions/crashes. Such hazards include but are not limited to debris, downed utility lines, damaged roadways, or disabled/abandoned vehicles. In order to mitigate these factors, officers that observe these types of hazards should:

- Contact dispatch and notify them of the location and type of roadway hazard (i.e., debris, disabled vehicle, damage to the road).
- Depending on the hazard, either remove or contact the appropriate service to remove or repair the hazard.
- Provide traffic control until the problem is either resolved or the officer is no longer needed by service teams responding to the problem.

500.9 TRAINING

It is the duty of the Department to properly inform and train sworn officers on any newly enacted laws or regulations that affect traffic compliance efforts and how to uniformly enforce those

Salt Lake City Police Department

SLCPD Policy Manual

SLCPD Policy Manual

Traffic Function and Responsibility

changes. This may be done by training bulletins, line-up training, or any other method the department utilizes to inform all sworn personnel.

500.10 REVISIONS

Enacted: April 9, 2018

Traffic Collision Reporting

501.1 PURPOSE AND SCOPE

The Salt Lake City Police Department prepares traffic collision reports in compliance with Utah Code, Title 41, Chapter 6a, Part 4.

Refer to the Hit and Run Policy for guidelines regarding Hit and Run traffic collisions.

501.2 TRAFFIC ACCIDENT GENERAL CONSIDERATIONS

An investigating officer shall secure written witness statements from all parties and witnesses to a collision. Officers will provide the involved parties with driver exchange information via the Department's Driver Exchange Form. Officers shall also provide traffic control by utilizing vehicle emergency lights and temporary traffic control devices, if needed.

When investigating a traffic collision, officers will determine if the following documents are valid:

- Driver License or Driving Privilege Card
- Vehicle Registration
- Proof of insurance

Officers shall issue a traffic citation to a driver involved in a collision if any of the above-listed documents are found to be invalid.

If an investigating officer has established probable cause for any other traffic-related violations of state law or city ordinance, the investigating officer should issue a traffic citation.

The investigating officer shall notify their Sergeant or Watch Commander as to the condition of any victims. Victim condition will be based on the responding officer's observations, not the mechanism of injury as done by EMS personnel. Police condition codification is as follows:

- Alpha: Minor Injuries - complaints of pain, minor abrasions
- Bravo: Serious Injuries - broken extremities, minor bleeding wounds
- Charlie: Critical Injuries - broken neck, back, or compound fractures; multiple lacerations and uncontrollable bleeding; severe burns; severe head trauma
- Delta: Probable Fatal - not breathing and unconscious, along with other injuries indicating a probable fatality
- Echo: Obvious Fatality

A detailed diagram accompanied by measurements and photographs of the collision scene is required in all serious injury collisions with a condition verified by hospital personnel of Charlie or worse. While officers are authorized to photograph traffic collisions without injuries, as well as collisions with Alpha and/or Bravo injuries, Crime Lab should respond for photographs of traffic collisions resulting in Charlie injuries or greater (see the Investigative Photographing by Officers Policy).

Salt Lake City Police Department

SLCPD Policy Manual

SLCPD Policy Manual

Traffic Collision Reporting

If a diagram is needed, and the Collision and Reconstruction (CAR) Team is not responding, the primary responding officer will complete the diagram. Crime Lab has pedometers and Motors have LIDARs that may be used to assist with diagram measurements. Officers may review the attached Crash Diagram for Patrol document for additional guidance on how to complete a diagram. [See attachment: Crash Diagram For Patrol.pdf](#)

501.3 REPORTABLE VS NON-REPORTABLE COLLISIONS

A collision will be considered reportable and documented in a DI-9 report if:

- There is an injury;
- There is a fatality; or
- It is reasonably believed that the combined damage exceeds \$2,500

In addition to these requirements, the following collisions shall be investigated and must be documented in a DI-9 report.

- Collisions involving suspected DUI drivers.
- Collisions involving a school bus.
- Collisions involving City equipment.
- Collisions involving an outside police agency.
- Any other collision an officer deems is in need of a formal investigation.

If a collision does not meet the above criteria, Dispatch should direct the involved parties to the Online Reporting System at www.slcpd.com. Involved parties may still request an in-person police response.

In cases of collisions where the parties have exchanged names and insurance information and have left the scene:

- No police action will be taken;
- No information will be recorded;
- No case numbers will be provided; and
- No follow-up will be conducted.

The parties will be advised that the matter is entirely civil.

501.3.1 RESPONSE TO A NON-REPORTABLE ACCIDENT

In cases where an involved party still requests a police response to a traffic collision that is considered non-reportable, the response will include the following services:

- Traffic control;
- Assistance with tow trucks;

Salt Lake City Police Department

SLCPD Policy Manual

SLCPD Policy Manual

Traffic Collision Reporting

- Driver exchange information - Business card and/or case number alone will not satisfy the exchange information. The Department's exchange forms will be completed in full.
- Examination of the following documents:
 - Driver License or Driver Privilege Card
 - Vehicle Registration
 - Proof of Insurance
- Issuance of a traffic citation to the offending driver if any of the documents listed above are found to be invalid or in violation of state code or city ordinance.
- If an officer has established probable cause for any other traffic-related violations of state law or city ordinance, the investigating officer should issue a traffic citation.

501.4 REPORTING SITUATIONS

501.4.1 TRAFFIC COLLISIONS INVOLVING CITY VEHICLES

Traffic collision investigation reports shall be taken when a City-owned vehicle is involved in a traffic collision upon a roadway or highway wherein any damage or injury results. A general information report may be taken in lieu of a traffic collision report at the direction of a supervisor when the collision occurs on private property or does not involve another vehicle. Whenever there is damage to a City vehicle, photographs shall be taken.

501.4.2 TRAFFIC COLLISIONS INVOLVING DEPARTMENT EMPLOYEES

[See attachment: Accident Flow Chart Involving Department Employees.pdf](#)

When an employee of the Department is involved in a traffic collision, the investigation shall be handled based on the following qualifying levels:

- A. Level 2 Collision - A level 2 collision occurs when a Department employee operating a vehicle owned or leased by the City collides with a fixed object or other City-owned/leased vehicle or property resulting in minor (non-reportable) damage to only the City-owned/leased vehicle or property.
 1. The involved employee shall immediately notify a Sergeant or Watch Commander.
 2. The involved employee shall complete a Salt Lake City Employee Accident Report Form and forward it to the Sergeant or Watch Commander handling the collision report. The supervisor will forward the form to the Fleet Coordinator, who is responsible for forwarding the form to the City's Risk Management Office.
 3. Photos shall be taken of the damage. The photos for a level 2 collision may be taken with an adequate phone camera.
 4. The collision shall be entered into BlueTeam within 12 hours of the time of occurrence. The BlueTeam entry shall be made by the handling supervisor, or a designee within the same Division. The BlueTeam entry shall include a copy of the Accident Report Form and the photos taken of the damage.
 5. No other reports are necessary.

Salt Lake City Police Department

SLCPD Policy Manual

SLCPD Policy Manual

Traffic Collision Reporting

- B. Level 1 Collision - A level 1 collision occurs when a Department employee operating a vehicle owned or leased by the City is involved in a collision resulting in damage to property owned by anyone other than the City, or involves injuries, regardless of the extent (reportable).
1. Level 1 Collisions within the City
 - (a) The involved employee shall immediately notify a Sergeant or Watch Commander.
 - (b) The Watch Commander or designee will ensure that an officer is assigned to complete an initial report for the collision.
 - (c) Officers shall secure written witness statements from parties involved and witnesses to the collision.
 - (d) Officers are authorized to photograph traffic collisions with Alpha and/ or Bravo injuries. Crime Lab should respond for photographs of traffic collisions resulting in Charlie injuries or greater.
 - (e) The collision investigation (i.e., DI-9) shall be handled by an outside agency.
 - (f) In cases where there are serious injuries or a fatality, the Collision and Reconstruction (CAR) Team shall be called.
 - (g) The involved employee shall complete a Salt Lake City Employee Accident Report Form and forward it to the Sergeant or Watch Commander handling the collision report. The supervisor will forward the form to the Fleet Coordinator, who is responsible for forwarding the form to the City's Risk Management Office.
 - (h) The collision shall be entered into BlueTeam within 12 hours of the time of occurrence. The BlueTeam entry shall be made by the handling supervisor, or a designee within the same Division. The BlueTeam entry shall include a copy of the Accident Report Form and any relevant reports from the investigating agency.
 - (i) In cases where there is a fatality to any person other than the officer, the OICI Protocol shall be utilized (see the Officer-Involved Shootings and Deaths Policy).
 2. Level 1 Collisions outside the City
 - (a) The involved employee shall notify the Watch Commander as soon possible.
 - (b) The agency having geographic jurisdiction over the collision location will handle the collision investigation.
 - (c) The Watch Commander or designee will ensure that an officer is assigned to respond to the scene and complete an initial report for the collision.
 - (d) The Watch Commander or their designee will respond to the scene for coordination with the investigating agency.

Salt Lake City Police Department

SLCPD Policy Manual

SLCPD Policy Manual

Traffic Collision Reporting

- (e) The Watch Commander or designee will coordinate with the investigating agency to ensure a DI-9 is completed, photographs are taken, and witness statements are preserved.
- (f) If the investigating agency is not photographing the collision, Crime Lab shall respond for photographs of traffic collisions involving Charlie injuries or greater. The officer assigned to respond is authorized to photograph traffic collisions with no injuries, or Alpha and/or Bravo injuries.
- (g) The involved employee shall complete a Salt Lake City Employee Accident Report Form and forward it to the Sergeant or Watch Commander handling the collision report. The supervisor will forward the form to the Fleet Coordinator, who is responsible for forwarding the form to the City's Risk Management Office.
- (h) The collision shall be entered into BlueTeam within 12 hours of the time of occurrence. The BlueTeam entry shall be made by the handling supervisor, or a designee within the same Division. The BlueTeam entry shall include a copy of the Accident Report Form and any relevant reports from the investigating agency.

Any Department vehicle involved in a collision shall be turned into Fleet as soon as practicable for a collision damage assessment, regardless of the extent of the damage.

501.4.3 TRAFFIC COLLISIONS INVOLVING OTHER CITY EMPLOYEES OR OFFICIALS

The Investigations Division Property Crimes Lieutenant or on-duty Watch Commander may request assistance from the Collision and Reconstruction (CAR) Team for the investigation of any traffic collision involving any City official or employee where a serious injury or fatality has occurred.

501.4.4 TRAFFIC COLLISIONS ON PRIVATE PROPERTY

In compliance with Utah Code 41-6a-402, traffic collision reports shall be taken for traffic collisions occurring on private property when the accident results in injury to, or death of any person, or total property damage to the apparent extent of \$2,500 or more. An incident report may be taken at the discretion of any supervisor. If there is no injury or indication of impairment, Dispatch should refer the involved parties to the Online Reporting System at www.slcpd.com. Involved parties may still request an in-person police response.

501.4.5 TRAFFIC COLLISIONS ON SPECIFIED ROADWAYS OR HIGHWAYS

Under an agreement between this department and the Utah Highway Patrol, the UHP will, if units are available, investigate accidents occurring in the following areas:

- (a) Freeways and freeway on-ramps and off-ramps
- (b) North Temple, west of 2150 West (I-80)
- (c) SR-201
- (d) 600 North, from 400 West to 800 West
- (e) Beck Street, north of 2150 North

Salt Lake City Police Department

SLCPD Policy Manual

SLCPD Policy Manual

Traffic Collision Reporting

- (f) 2100 South (proper) from 300 West to 700 West
- (g) Bangerter Highway

501.4.6 TRAFFIC COLLISIONS INVOLVING LIVESTOCK

An officer investigating a collision shall indicate in the report whether the accident occurred on a highway designated as a livestock highway, in accordance with Utah Code 72-3-112, when the collision resulted in the injury or death of livestock (Utah Code 41-6a-404).

An officer investigating such a collision shall make reasonable efforts as soon as practicable to (Utah Code 41-6a-408):

- (a) Locate and inform the owner of the livestock of the incident.
- (b) Make arrangements with the owner of the livestock to provide a copy of the collision report or advise the owner where a copy can be obtained.

501.4.7 COLLISIONS INVOLVING TRAINS

Pedestrian and bicycle collisions involving a train are not considered traffic collisions but considered industrial accidents. Responding officers will document injuries and fatalities accordingly (see the Industrial Accidents Procedure).

501.4.8 COLLISIONS INVOLVING TRAX

TRAX light-rail service is a scheduled commuter service requiring immediate response to emergencies to facilitate continuing service. Police response should be prompt, with attention to restoring full service or amended service as quickly as possible. Accidents involving a TRAX light-rail shall be dispatched as a priority 2 or above.

TRAX service can be maintained with a single track. As such, blockage of both tracks with vehicles and emergency responders during an incident should be avoided if possible. Clearing one of the tracks as soon as possible will facilitate maintenance and service. Evacuation, derailments, or requests for assistance will be handled in coordination with UTA officials, the Fire Department, and other relevant agencies. Maintaining public safety is the primary goal. The secondary goal is the restoration of TRAX service.

Officers will respond to incidents involving TRAX light-rail trains in accordance with the following procedures:

- (a) Officers will respond as with any other traffic collision, with an initial focus on injuries, traffic mitigation, and investigation. TRAX supervisors will facilitate an exchange of information, including the light-rail operator's license.
- (b) Injury and fatal accidents will be handled as any traffic accident with similar injuries or fatalities. Location of the TRAX vehicle can be marked as any other vehicle. Restoring full or limited service should be expedited as the investigation permits.
- (c) Where impairment by either drugs or alcohol on the part of the TRAX operator is suspected, UTA, on behalf of the Federal Transit Administration, will conduct a

Salt Lake City Police Department

SLCPD Policy Manual

SLCPD Policy Manual

Traffic Collision Reporting

chemical test as mandated by federal regulations. Motor vehicle operators are subject to state DUI statutes.

- (d) A DI-9 shall be completed by the initial officer.

501.4.9 EXTREME WEATHER OR HIGH DEMAND SITUATIONS

Extreme weather conditions, unusual circumstances, and periods of high call volume place an extraordinary demand on police services. During such periods, the Watch Commander is authorized to direct Dispatch to request involved parties file an online report at www.slcpd.com and remove their cars from the roadway. A dispatch log report will be made and a case number assigned. Dispatch should advise all involved parties to exchange information and contact their vehicle insurance company.

Dispatch may also facilitate towing service for involved parties using the next-in-line system. Those who still request a police response shall be told there will be a significant delay in the police response due to the existing circumstances, but an officer will be dispatched when available. In these cases, calls will be handled as provided in this policy.

501.4.10 TRAFFIC COLLISIONS INVOLVING DEATH OR PROBABLE DEATH

If a collision involves a fatality or probable fatality:

- (a) The Watch Commander or designee shall respond to the scene and ensure the scene has been identified and secured.
- (b) The Watch Commander shall request assistance from the Collision and Reconstruction (CAR) Team.
- (c) The scene, including a reasonable distance beyond the scene itself, must be secured and maintained until processed.
- (d) Officers shall identify witnesses to be interviewed and obtain written witness statements, with officers verifying the statements are filled out completely and signed by the witness(es).
- (e) An officer will initiate a Major Incident Log. The log will be submitted to Records.
- (f) The initial officer shall complete a DI-9 report, to include all available witness contact information.
- (g) All officers responding to the incident will complete and submit a supplemental report describing their actions.
- (h) If needed, the City's contracted barricade company should be directed to respond to assist with road closures in order to minimize the impact on field operations.

Once investigative personnel have arrived, assigned patrol officers will assist as directed.

The Medical Examiner's Office has jurisdiction over all traffic collision-related deaths. If a death occurs as a result of a traffic collision, the responding CAR Team Sergeant or designee will contact the Medical Examiner's Office and advise them of the fatality. The CAR Team Sergeant or designee contacting the Medical Examiner's Office will provide all information required by that

Salt Lake City Police Department

SLCPD Policy Manual

SLCPD Policy Manual

Traffic Collision Reporting

office for their investigation. The body should not be moved until investigators from the Medical Examiner's Office authorize such.

Collisions involving a fatality or probable fatality will be screened for charges by the CAR Team.

In compliance with Utah Code 41-6a-202, an officer who issues a citation to a person for a moving traffic violation which results in a collision causing serious bodily injury or death shall note that fact on the citation.

501.5 CRITERIA FOR REQUESTING THE CAR TEAM

In all accidents where a fatality or probable fatality to any person may be imminent, the Collision and Reconstruction (CAR) Team will be requested. In all accidents involving law enforcement where serious bodily injury or death to civilians occur, the Officer Involved Critical Incident (OICI) Protocol will be followed (see the Officer-Involved Shootings and Deaths Policy), and the CAR Team shall be called out. CAR Team requests will be made by notifying the Investigations Division Property Crimes Lieutenant or on-duty Watch Commander who will notify the CAR Team through the Unified Police Department's Dispatch Office at 801-743-3000.

The following are incidents when the CAR Team shall be called:

- Any collision involving the fatality or probable fatality of any person.
- All serious injury collisions involving any employee of the Department occurring within City limits and:
 - The employee was on-duty; or
 - The employee was in a Department vehicle; or
 - The employee was acting in an official capacity.
- All serious injury collisions involving an officer of another law enforcement agency occurring within City limits and:
 - The officer was on-duty; or
 - The employee was in an agency vehicle; or
 - The officer was acting in an official capacity.
- A vehicle pursuit resulting in a collision causing serious injuries or fatality to any of the involved parties or bystanders.

501.6 DUI INVOLVED ACCIDENTS AND BLOOD DRAWS

In an accident where there is evidence that one or more of the involved drivers may be impaired, officers will investigate and attempt to determine the level of impairment. If the officer obtains probable cause that one or more of the involved drivers is impaired, the officer shall secure a blood draw. A blood draw is a search and seizure. As such, blood draws are subject to established search and seizure laws, including the exigent circumstance exception.

The existence of exigent circumstances in cases of blood draws is very narrow and will be scrutinized heavily by the courts on a case-by-case basis. Courts have ruled that the natural

Salt Lake City Police Department

SLCPD Policy Manual

SLCPD Policy Manual

Traffic Collision Reporting

metabolism of blood alcohol does not establish a per se exigency that would justify a blood draw without consent, and courts disfavor the practice of obtaining warrantless blood draws when an e-warrant can be obtained relatively quickly.

501.6.1 BLOOD DRAWS

Implied Consent shall not be utilized as a method for obtaining a blood draw. Officers shall utilize the options of voluntary consent, a search warrant, or a medical draw:

- **Consent** - The initial officer shall request the driver(s) to submit to a blood draw. If the driver(s) consent(s) and that consent is properly documented, normal blood draw related procedures will be followed (see the Forensic Blood Draw Policy and Blood Draw Procedure).
- **Search Warrant** – If a driver is unwilling to give a blood sample, or is unconscious or otherwise incapacitated, the CAR Team Sergeant will be notified immediately. If probable cause has been established, a search warrant for a blood draw will be sought by CAR Team personnel.
- **Medical Draw** – Circumstances may arise where a driver is in a medical condition that is prohibitive to a Department phlebotomist conducting a blood draw. In these circumstances, medical staff at a hospital can conduct the blood draw at the responding Department phlebotomist's direction if:
 - The driver provides consent. If the blood draw is completed based on the driver's consent, the medical staff may require a signed consent form for their records. Officers can find the Department's Blood Draw Consent Form [See attachment: Blood Draw Consent Form.pdf](#); or
 - The Department phlebotomist provides a search warrant. In these cases, the Department phlebotomist is responsible for obtaining the drawing staff's information for chain of custody documentation purposes.

Blood will be taken from a deceased person only by the Medical Examiner's Office and tested through that office as part of their investigation.

If an officer believes that exigent circumstances exist in a particular case, and believes there is not time to obtain a search warrant for a blood draw, that officer shall contact the Watch Commander. The Watch Commander will be responsible for authorizing or denying a blood draw under the exigent circumstances exception.

501.7 MEDIA REQUESTS

In the event a Public Information Officer is not called to the scene of an accident, or is unable to respond, the Watch Commander will facilitate media requests as appropriate.

501.8 REVISIONS

Enacted: April 9, 2018

Revised: June 29, 2020

Hit and Run Collisions

502.1 PURPOSE AND SCOPE

This policy provides guidance on reporting requirements for, and investigation of, Hit and Run Collisions. Officers should refer to the Traffic Collision Reporting Policy for basic requirements of traffic collision investigations.

502.2 HIT AND RUN INCIDENTS WITH INJURIES

If anyone has been injured in a Hit and Run collision an officer shall respond, conduct an investigation, and document the collision in a DI-9.

Crime Lab shall document any evidence of injury.

Officers will record current phone numbers for all parties involved.

If the suspect vehicle in a Hit and Run with injuries is left at the scene or located, it shall be impounded via a State Tax Impound with a hold for Hit and Run detectives placed on it (see the Vehicle Towing and Release Policy and Procedure).

502.3 HIT AND RUN INCIDENTS WITHOUT INJURIES

Dispatchers - When call-takers can determine that a Hit and Run collision does not involve injuries, there is no viable suspect information, and there is no other need for police at the scene, the call-taker may complete a dispatch log, issue a case number, and refer the victim to the Online Reporting System at www.slcpd.com. If a victim requests a police response, one will be provided. In these instances, the dispatcher should advise the victim of possible response delays due to call volume.

Officers - If there is viable suspect information, a responding officer shall conduct a field investigation and seek an arrest; no follow-up investigation will be conducted by investigative personnel. If an arrest is made, the following documentation is required:

- (a) A DI-9 shall be completed.
- (b) Crime Lab shall document evidence, including vehicle damage.
- (c) Officers will obtain current phone numbers for all parties involved.

502.3.1 SUSPECT DRIVER AND VEHICLE NO LONGER AT THE SCENE - NO ARREST

If both the suspect driver and the suspect vehicle have left the scene, an officer responds, and no arrest is made:

- (a) If it is reasonably believed that the total damage does not exceed \$2500, the primary officer shall complete an initial report.
- (b) If it is reasonably believed that the total damage exceeds \$2500, the collision will be documented in a DI-9.
- (c) The officer shall provide the case number to the victim and direct the victim to contact their insurance company.

Salt Lake City Police Department

SLCPD Policy Manual

SLCPD Policy Manual

Hit and Run Collisions

502.3.2 SUSPECT DRIVER HAS FLED BUT SUSPECT VEHICLE STILL AT THE SCENE - NO ARREST

If the suspect driver has fled the scene, the suspect vehicle is still present, and no arrest is made:

- (a) The suspect vehicle shall be impounded via State Tax Impound, however, a hold for Hit and Run detectives is not necessary if there are no injuries.
- (b) If it is reasonably believed that the total damage does not exceed \$2500, the collision and vehicle impound will be documented in an initial report.
- (c) If it is reasonably believed that the total damage exceeds \$2500, the collision will be documented in a DI-9.
- (d) The officer shall provide the case number to the victim and direct the victim to contact their insurance company.

502.4 REVISIONS

Enacted: April 9, 2018

Revised: April 12, 2022

Vehicle Towing and Release

503.1 PURPOSE AND SCOPE

This policy provides guidance to members of the Salt Lake City Police Department when towing a vehicle.

503.2 POLICY

Officers of the Salt Lake City Police Department may impound vehicles as a means of enforcing local and state laws, removing a public hazard or nuisance, or securing evidence. Impounds can, however, impose unnecessary expense and inconvenience to the public and the Department. The legal grounds for impounding a vehicle must be tempered with discretion and common sense. Impounding on technicalities contrary to the spirit or intent of the law is not a prudent action. Moreover, generally, a vehicle should not be impounded if the impoundment of the vehicle would pose a safety concern to the operator or any of its occupants.

503.3 TOWING SERVICES

The Salt Lake City Police Department coordinates towing services in the following situations:

- (a) When it is necessary to safeguard a vehicle due to the inability of the owner or operator to take the required action.
- (b) When a vehicle is being held as evidence in connection with an investigation.
- (c) When it is otherwise necessary to store a motor vehicle. This would include situations involving the recovery of stolen or abandoned vehicles, and the removal from the streets of vehicles in violation of state or local regulations.

All vehicle impounds, unless specifically stated otherwise in this policy or associated procedure, will be conducted via State Tax Impound.

503.3.1 IMPOUND FOR EXPIRED REGISTRATION

Occupied Vehicles - In cases where a vehicle displaying expired registration is accompanied by the owner or a responsible party, the following applies:

- If the registration is expired less than three months, do not impound.
- If the registration is expired by three months or more, and verification can be obtained, an impound may be in order.

Officers may exercise discretion on the side of not impounding as the facts of the situation dictate.

Unoccupied Vehicles - Unoccupied vehicles will not be impounded for expired registration relying solely upon the information provided by the state computer system (see the Abandoned Vehicles Policy).

503.3.2 IMPOUND FOR LACK OF PROOF OF SECURITY - COLLISIONS

If the operator of a vehicle involved in a collision cannot provide proof of security as required by Utah Code 41-12a-301, the vehicle shall be impounded after the officer confirms that the

Salt Lake City Police Department

SLCPD Policy Manual

SLCPD Policy Manual

Vehicle Towing and Release

security is not in effect through query of the Uninsured Motorist Identification Database (Utah Code 41-1a-1101).

503.3.3 IMPOUND FOR LACK OF PROOF OF SECURITY - NON-COLLISIONS

If the operator of a vehicle cannot provide proof of security as required by Utah Code 41-12a-301, and the officer confirms that the security is not in effect through query of the Uninsured Motorist Identification Database, the vehicle may be impounded.

If the operator of a vehicle can provide proof of security, but a query of the Uninsured Motorist Identification Database does not confirm the security, the vehicle should not be impounded.

503.4 TOWING FROM PUBLIC AND PRIVATE PROPERTY

Removal and towing of vehicles from public and private property shall follow all Utah State Law requirements. Questions regarding the legality of towing a vehicle should be directed to a sworn supervisor.

503.5 REPORTS AND COMPLETION OF NOTICE OF IMPOUND

All impounds shall be documented in an initial report or supplemental report.

When impounding a vehicle, officers shall complete a Utah State Tax Commission Vehicle Impound Report TC-540 Form (TC-540 Form). Members shall follow proper procedures when completing the TC-540 Form. [Salt Lake City Police Department Procedure Manual: 500.2 TC-540 FORM](#)

503.6 IMPOUND HOLDS AND RELEASES

There are circumstances when a vehicle is involved in the commission or attempted commission of a crime but does not need to be forensically processed. In these situations, good judgment tempered with common sense should be exercised. Once it has been determined the vehicle needs to be impounded and held for investigative purposes, the proper procedures shall be followed. [Salt Lake City Police Department Procedure Manual: 500.3 IMPOUND HOLDS AND RELEASES](#)

It is not appropriate to seize a vehicle simply to avoid booking stolen property contained inside of the vehicle.

503.7 VEHICLE INVENTORY

All property in an impounded vehicle shall be inventoried and listed on the TC-540 Form. This includes the trunk and any compartments or containers, even if closed and/or locked. Locked containers will be opened in the presence of another officer or supervisor if the locks must be forced or otherwise damaged in order to open them.

Members conducting inventory searches should be as thorough and accurate as practical in preparing an itemized inventory. These inventory procedures are for the purpose of protecting an owner's property while in police custody, to provide for the safety of officers, and to protect the Department against fraudulent claims of lost, stolen or damaged property.

Salt Lake City Police Department

SLCPD Policy Manual

SLCPD Policy Manual

Vehicle Towing and Release

503.8 VEHICLE KEYS

The impounding officer is responsible for securing the vehicle keys and providing them to the tow truck operator. The officer should not retain the keys. If the vehicle keys are not available, it should be documented on the TC-540 Form and in the officer's report.

503.9 SECURITY OF VEHICLES AND PROPERTY

Unless it would cause an unreasonable delay in the completion of a vehicle impound/storage or create an issue of officer safety, officers should make reasonable accommodations to permit a driver/owner to retrieve small items of value or personal need (e.g. cash, jewelry, cell phone, prescriptions) which are not considered evidence or contraband.

503.10 STORAGE AT ARREST SCENES

The following are examples of situations where consideration may be given to leaving a vehicle at the scene of an arrest in lieu of impoundment:

- When the licensed owner of the vehicle is present, willing, and able to take control of any vehicle not involved in criminal activity.
- When the vehicle otherwise does not need to be impounded and the owner requests that it be left at the scene, so long as it is lawfully parked.

In such cases, the handling employee shall note in the report that the owner was informed that the Department will not be responsible for theft or damages.

503.11 VEHICLE EVIDENCE SEIZURE AND RELEASE

If a vehicle is seized and requires forensic processing or to be held as evidence, proper procedures shall be followed. [Salt Lake City Police Department Procedure Manual: 500.4 VEHICLE EVIDENCE SEIZURE AND RELEASE](#)

503.12 NEXT-IN-LINE ASSIST

The purpose of a next-in-line assist tow is to facilitate a service and clear the roadway for other commuters. The following are situations when an officer should use a next-in-line assist:

- (a) A vehicle owner requests or requires a tow truck.
- (b) When the removal of a vehicle is necessary in the interest of public safety because of a vehicle collision, fire, flood, storm, snow, or other emergency reason, or for the safety of the vehicle and its contents.
- (c) If a vehicle is, in the reasonable judgment of an officer, hazardous to operate, and the peace officer is not otherwise impounding the vehicle, the officer may require the vehicle be towed.

Next-in-line towing requests shall be made on the dispatch service channel. The dispatcher will contact the next towing company in rotation from the rotational list maintained in Dispatch and make appropriate entries on that list to ensure the following towing company is called on the next request.

Vehicles towed as a next-in-line assist shall not be inventoried as they are not an impound.

Salt Lake City Police Department

SLCPD Policy Manual

SLCPD Policy Manual

Vehicle Towing and Release

503.13 VEHICLE RELOCATIONS

Vehicle relocations are a courtesy to the vehicle owner and will only be done under special circumstances.

Vehicles may be relocated during special events (e.g., Salt Lake Marathon, Days of 47 Parade, etc.) at the instruction of the Special Events Lieutenant.

Officers may also arrange for the relocation of vehicles at the request of other City departments. Officers will explain to the representatives of the requesting City department that the relocation will be at the expense of that department.

Only those towing companies specified by contractual agreement with the City will be used to relocate vehicles, and proper procedure shall be followed. [Salt Lake City Police Department Procedure Manual: 500.5 VEHICLE RELOCATIONS](#)

503.14 DRIVING A NON-CITY VEHICLE

Vehicles which have been towed by or at the direction of the Department should not be driven by police personnel unless it is necessary to move a vehicle a short distance to eliminate a hazard, prevent the obstruction of a fire hydrant, or to comply with posted signs.

503.15 REVISIONS

Enacted: April 9, 2018

Impaired Driving

504.1 PURPOSE AND SCOPE

This policy provides guidance to those department members who play a role in the detection and investigation of driving under the influence (DUI).

For more specific directions on how to complete different types of DUI investigations and complete DUI forms, refer to the DUI Procedure.

504.2 POLICY

The Salt Lake City Police Department is committed to the safety of the roadways and the community and will pursue fair but aggressive enforcement of Utah's impaired driving laws.

504.3 INVESTIGATIONS

All Officers are reminded that DUI enforcement is not an exclusive assignment and are expected to enforce these laws when appropriate. Officers assigned to the Motor Squad will have the primary responsibility for proactive DUI enforcement efforts.

Any DUI investigation will be documented on a standard Utah State DUI Summons and Citation with an accompanying report form. Information that should be documented includes, at a minimum:

- (a) The Standardized Field Sobriety Tests (SFSTs) that were administered and the results.
- (b) The officer's observations that indicate impairment, and any health-related issues that could significantly invalidate the results of the SFST's or have contributed to the officer's observations.
- (c) Witnesses and their observations.
- (d) The location, time, and how actual physical control of the vehicle was determined.
- (e) Any prior related convictions in Utah or another jurisdiction.

504.4 FIELD TESTS

The standardized FSTs should be used when investigating violations of DUI laws. Alternate tests (e.g., Finger Count, Hand Slap, Modified Romberg Balance Test, Finger to Nose Test) should be considered when an individual has health-related issues that could significantly invalidate the results of the SFST's

504.5 CHEMICAL TESTS

A person implies consent under Utah law to a chemical test or tests, and to providing the associated chemical sample, under any of the following (Utah Code 41-6a-520):

- (a) The officer has reasonable grounds to believe that the person was operating or had actual physical control of a motor vehicle while:

Salt Lake City Police Department

SLCPD Policy Manual

SLCPD Policy Manual

Impaired Driving

1. Having a prohibited blood or breath alcohol content level as defined by Utah Code 41-6a-502 (DUI), Utah Code 41-6a-530 (Alcohol Restricted Drivers) or 53-3-231 (Not a Drop).
2. Under the influence of alcohol, any drug, or combination of alcohol and any drug.
3. Having any measurable controlled substance or metabolite of a controlled substance in the person's body 41-6a-517 (Metabolite).

If a person withdraws this implied consent (refused a formal request for a chemical test), or is unable to withdraw consent (e.g., the person is unconscious), the officer will consider implied consent revoked and proceed as though the person has refused to provide a chemical sample (refer to the Forensic Blood Draws Policy and Blood Draw Procedure for direction on how to obtain a blood draw under these circumstances).

Breath analysis results (BAC), refusal, or blood/urine pending should be noted in the "For Court Use Only" box in the bottom left quadrant of the DUI citation.

504.5.1 STATUTORY NOTIFICATIONS

An officer requesting that a person submits to a chemical test shall provide the person with a mandatory warning pursuant to Utah Code 41-6a-520 (Refusal Admonition).

504.5.2 SELECTION OF CHEMICAL TEST

The investigating officer shall determine which chemical test or tests to administer to a person and how many tests will be administered. In the event that an officer requests that the person submit to more than one test, refusal by the person to take one or more of the requested tests, even if the person has already submitted to one test, is nonetheless considered a refusal under state DUI laws (Utah Code 41-6a-520).

504.5.3 BREATH SAMPLES

A Utah Highway Patrol Alcohol Technician will ensure that all formal devices used for the collection and analysis of breath samples are properly serviced and tested and that a record of such service and testing is properly maintained.

Officers obtaining a breath sample should monitor the device for any sign of malfunction. Any anomalies or equipment failures should be noted in the appropriate report and promptly reported to the Alcohol Technician listed on the device. If a malfunction cannot be corrected by the officer or the technician (and a valid sample is needed) a different device or method will be utilized.

504.5.4 BLOOD SAMPLES

Only persons authorized by law to draw blood shall collect blood samples (Utah Code 41-6a-523; Utah Code 77-23-213). The blood draw should be witnessed by the assigned officer.

The blood sample shall be packaged, marked, handled, stored and transported according to the Department's Blood Draw Procedure. Officers should document if the blood was taken by consent or by a warrant, and the individual that took the blood sample.

Salt Lake City Police Department

SLCPD Policy Manual

SLCPD Policy Manual

Impaired Driving

504.5.5 URINE SAMPLES

If a urine test is requested, the arrestee shall be transported to a private location (e.g. restroom). The officer shall follow any directions accompanying the urine evidence collection kit.

Urine samples shall be collected and witnessed by an officer or jail staff member of the same sex as the person giving the sample. The arrestee tested should be allowed sufficient privacy to maintain his/her dignity, to the extent possible, while still ensuring the accuracy of the sample.

The sample shall be packaged, marked, handled, stored and transported as per Department evidence handling procedures.

504.5.6 ADDITIONAL TESTING

A person may have qualified medical personnel administer an additional test, at the person's own expense. The additional test shall be administered subsequently to that which is administered at the direction of the officer (Utah Code 41-6a-520).

504.6 REFUSALS

When an arrestee refuses to provide a chemical sample, officers should:

- (a) Advise the arrestee of the requirement to provide a sample (Utah Code 41-6a-520, Refusal Admonition).
- (b) If practicable, an audio- and/or video-record of the admonishment and the response should be obtained.
- (c) Document the refusal in the appropriate report.

504.6.1 BLOOD SAMPLE WITHOUT CONSENT

A blood sample may be obtained from a person who refuses a chemical test when a search warrant has been obtained.

504.6.2 FORCED BLOOD SAMPLE

If an arrestee indicates by word or action that he/she will physically resist a blood draw, the officer shall follow the forced blood draw procedure outlined in the Forensic Blood Draws Policy.

504.7 ARREST AND INVESTIGATION

504.7.1 ARREST AUTHORITY

An officer may make a warrantless arrest of a person that the officer has probable cause to believe has violated the DUI laws of this state, whether or not the offense occurred in the officer's presence (Utah Code 41-6a-508).

It shall be mandatory to book the arrested person in jail if:

- The person is being charged with a felony or class A misdemeanor charge.
- The person cannot be identified by reliable means.
- The person is driving on DUI revocation.

Salt Lake City Police Department

SLCPD Policy Manual

SLCPD Policy Manual

Impaired Driving

- The person is combative.
- No responsible person is willing to accept responsibility for the arrested person or if the responsible person contacted takes, or will take, more than 1 hour to arrive.
- If for any reason the officer believes the person will not appear as directed.

When an arrested person is booked into jail the officer shall indicate "Booked" on the signature line of the DUI form, indicate "no print, booked" in the print section, and edit the court instructions in the "notice to appear in" section as "according to pre-trial release".

504.7.2 VEHICLE IMPOUNDMENT

An officer who arrests a person for DUI shall seize and impound the vehicle the person was driving at the time of the arrest. If a registered owner of the vehicle, other than the operator, is present at the time of arrest the peace officer may release the vehicle to that registered owner; but, only on the conditions that the registered owner requests to remove the vehicle from the scene, has sufficiently proven ownership, holds a valid driver license, and would not be in violation of DUI law themselves (Utah Code 41-6a-527). In most situation's a state tax impound will be used to seize a vehicle involved in a DUI arrest.

504.7.3 OFFICER RESPONSIBILITIES

An officer serving a person with a notice of the DLD intention to revoke the person's driving privilege or license shall also (Utah Code 41-6a-520):

- (a) Provide the person with basic information regarding how to obtain a hearing before DLD.
- (b) Forward a report to DLD within 10 days of giving the notice to the person that the officer had reasonable grounds to believe the arrested person was DUI and that the person refused to submit to a chemical test as required by law.

504.7.4 SELECTION OF CHEMICAL TEST

The investigating officer shall determine which chemical test or tests to administer to a person and how many tests will be administered. In the event that an officer requests that the person submit to more than one test, refusal by the person to take one or more of the requested tests, even if the person has already submitted to one test, is nonetheless considered a refusal under state DUI laws (Utah Code 41-6a-520).

504.8 RECORDS UNIT RESPONSIBILITIES

The Records Director will ensure that all case-related records are transmitted according to current records procedures and as required by the prosecuting attorney's office.

504.9 ADMINISTRATIVE HEARINGS

The Records Director will ensure that all case-related records are transmitted according to current records procedures and as required by the prosecuting attorney's office.

Salt Lake City Police Department

SLCPD Policy Manual

SLCPD Policy Manual

Impaired Driving

504.10 TRAINING

The Training Lieutenant should ensure that officers participating in the enforcement of DUI laws receive regular training. Training should include, at minimum, current laws on impaired driving, investigative techniques and rules of evidence pertaining to DUI investigations. The Training Lieutenant shall also ensure that each officer receives training on the current standard field sobriety testing guidelines established by National Highway Traffic Safety Administration (Utah Code 41-6a-515.6).

The Training Lieutenant should confer with the prosecuting attorney's office and update training topics as needed.

504.11 REVISIONS

Enacted: April 9, 2018

Revised: December 17, 2018

Revised: June 29, 2020

Traffic Citations

505.1 PURPOSE AND SCOPE

This policy outlines the responsibility for traffic citations, the procedure for dismissal, correction, and voiding of traffic citations.

505.2 RESPONSIBILITIES

The Special Events/Motor Lieutenant shall be responsible for the development and design of all Department traffic citations in compliance with state law and the Judicial Council.

The Quartermaster shall be responsible for the supply and accounting of all traffic citations issued to employees of the Department.

505.3 DISMISSAL OF TRAFFIC CITATIONS

Employees of the Department do not have the authority to dismiss a citation once it has been issued. Only the court has the authority to dismiss a citation that has been issued (Utah Code 77-7-26). Any request from a recipient to dismiss a citation shall be referred to the Watch Commander. Upon a review of the circumstances involving the issuance of the traffic citation, the Watch Commander may request a Patrol Division Commander to recommend dismissal of the traffic citation. If approved, the citation will be forwarded to the appropriate court with a request for dismissal. All recipients of traffic citations whose request for the dismissal of a traffic citation has been denied shall be referred to the appropriate court.

505.4 DISPOSITION OF TRAFFIC CITATIONS

Citations shall be filed with the Records Unit. Upon separation from employment with this department, all employees issued traffic citations shall return any unused citations to the Quartermaster.

505.5 PARKING VIOLATION APPEAL PROCEDURE

Disposition of parking violation appeals is conducted by City Parking Enforcement and not by this department.

505.6 JUVENILE CITATIONS

Completion of traffic citation forms for juveniles may vary slightly from the procedure for adults. The juvenile's age, place of residence, and the type of offense should be considered before issuing the juvenile a citation.

Adult courts have jurisdiction over traffic offenses committed by juveniles 16 and 17 years old, except traffic offenses that are part of a single criminal episode being referred to Juvenile Court.

All juveniles 16 years and over who are issued a citation will be instructed to appear in Adult Traffic Court. If the traffic offense is part of a "single criminal episode", the traffic offense should be included with all other criminal charges being referred to Juvenile Court; no traffic citation should be issued.

Salt Lake City Police Department

SLCPD Policy Manual

SLCPD Policy Manual

Traffic Citations

Juveniles under 16 years-of-age will be issued a juvenile citation.

Juvenile Court has exclusive jurisdiction over the following persons' age 17 or under:

- Automobile homicide
- Any drug- or alcohol-related traffic offense
- Reckless driving or reckless operation
- Fleeing from an officer
- Joyriding - unauthorized control over a vehicle

When a juvenile is arrested for driving under the influence (DUI) or "Not A Drop", a DUI summons and citation report form will be completed. For DUI and "Not A Drop" citations, notice to appear information must be completed as follows:

Court of: Juvenile Court

Located at: 450 South State Street

Salt Lake City, Utah 84111

Delete appearance instructions and write in - WHEN NOTIFIED BY JUVENILE COURT

505.7 LEGISLATIVE PRIVILEGE

Members of the Legislature shall not be subject to arrest during each general and special session of the Legislature or for 15 days immediately preceding and following each session, except for any felony, treason, or breach of the peace. Legislators may be issued a citation and a summons to appear at a date outside of the time of legislative privilege (Utah Constitution Article VI § 8). This immunity extends to traffic citations during those time periods.

505.8 MILITARY PRIVILEGE

Members of the National Guard shall not be subject to citation or arrest during military exercises or other duty when emergency circumstances require the member's presence, except for an act of treason, a class A misdemeanor or felony, breach of the peace, reckless driving, or DUI (Utah Code 39-1-54). All other traffic violations cannot be cited in these situations.

505.9 NON-RESIDENTS

Citations shall be issued to non-residents in the same manner as they are to residents of Salt Lake City. Non-residents who cannot appear on the assigned court date shall be directed to contact the appropriate court.

If the violation is criminal rather than civil, and the officer has reason to believe that a non-resident violator will not honor a written promise to appear, the officer should book the violator into jail. If the violator is booked into jail, a citation for the offense(s) will not be issued.

Salt Lake City Police Department

SLCPD Policy Manual

SLCPD Policy Manual

Traffic Citations

505.10 FOREIGN DIPLOMATS

Some foreign diplomats are allowed certain immunities from traffic violations (41-6a-1901). In the event that officers initiate a traffic stop on a foreign diplomat, refer to the Arrest or Detention of Foreign Nationals Policy.

505.11 REVISIONS

Enacted: April 9, 2018

Disabled Vehicles

506.1 PURPOSE AND SCOPE

All law enforcement agencies having responsibility for traffic enforcement should develop and adopt a written policy to provide assistance to motorists in disabled vehicles within the Department's primary jurisdiction.

506.2 OFFICER RESPONSIBILITY

When an on-duty officer observes a disabled vehicle on the roadway, the officer should make a reasonable effort to provide assistance. If that officer is assigned to a call of higher priority, the dispatcher should be advised of the location of the disabled vehicle and the need for assistance. The dispatcher should then assign another officer to respond for assistance as soon as practical.

An officer may remove a vehicle that has been involved in a collision without the consent of the owner if it is blocking a roadway or is otherwise endangering public safety (Utah Code 41-6a-401.9).

506.3 EXTENT OF ASSISTANCE

In some cases, a disabled motorist will require assistance. When arrangements for assistance are made, continued involvement by Department personnel will be contingent on the time of day, the location, and the vulnerability of the disabled motorist. If these actions cannot be accomplished safely, the officers shall provide traffic control until the vehicle can be removed from the roadway.

506.3.1 MECHANICAL REPAIRS

Department personnel shall not make mechanical repairs to a disabled vehicle.

506.3.2 RELOCATION OF DISABLED VEHICLES

The movement of disabled vehicles by members of this department by pushing a vehicle should only occur when the conditions reasonably indicate that immediate movement is necessary to reduce a hazard presented by the disabled vehicle.

Members may opt to push the disabled vehicle by hand off the roadway, taking into account traffic flow and other obstacles. If needed, secondary officers should be called to the scene to provide traffic control and a safety barrier.

506.4 REVISIONS

Enacted: April 9, 2018

Abandoned and Junk Vehicles

507.1 PURPOSE AND SCOPE

This policy provides procedures for the removal, recording, and storage of abandoned vehicles that are left unattended on a highway for a period in excess of 48 hours or on public or private property for a period in excess of seven days under the authority of Utah Code 41-6a-1408.

507.2 REMOVAL OF VEHICLES

Vehicles in violation of Utah Code 41-6a-1408 and by order of an officer of the Department shall be removed, at the owner's expense, by a tow truck motor carrier that meets the standards as described in Utah Code 72-9, The Motor Carrier Safety Act.

507.2.1 PRIVATE PROPERTY

It is generally the policy of this department to not remove abandoned vehicles from private property. Officers should refer property owners attempting to remove an abandoned vehicle to the Salt Lake County Department of Health Junk Removal Services or offer to call a next-in-line tow for the property owner.

507.2.2 RECORDING AND STORAGE OF IMPOUNDED ABANDONED VEHICLES

If an abandoned vehicle is impounded, officers shall follow the proper process as outlined in the Vehicle Towing and Release Policy and Procedure.

507.3 JUNK VEHICLES

A junk vehicle is one that has been stripped and only the chassis or shell remains, or any vehicle that is obviously inoperable and abandoned. An officer who observes a junk car on any public lot or public right-of-way should notify the Salt Lake County Board of Health by going to the following website and making a report of the vehicle:

<https://slco.org/health/report-a-problem/neighborhood-debris/>

It is not required to place a parking violation notice on any such vehicle.

507.4 REVISIONS

Enacted: April 9, 2018

Revised: June 29, 2020

Chapter 6 - Investigation Operations

Investigation and Prosecution

600.1 PURPOSE AND SCOPE

The purpose of this policy is to set guidelines and requirements pertaining to the handling and disposition of criminal investigations.

600.2 POLICY

It is the policy of the Salt Lake City Police Department to investigate crimes thoroughly and with due diligence, and to evaluate and prepare criminal cases for appropriate clearance or submission to a prosecutor.

600.3 INITIAL INVESTIGATION

600.3.1 OFFICER RESPONSIBILITIES

An officer responsible for an initial investigation shall complete no less than the following:

- (a) Make a preliminary determination of whether a crime has been committed by completing, at a minimum:
 - 1. An initial statement from any witnesses or complainants.
 - 2. A cursory examination for evidence.
- (b) If information indicates a crime has occurred, the officer shall:
 - 1. Preserve the scene and any evidence as required to complete the initial and follow-up investigation.
 - 2. Observe all relevant conditions, events, and remarks.
 - 3. Determine if additional investigative resources (e.g., investigators or scene processing) are necessary and request assistance as required.
 - 4. If assistance is warranted, or if the incident is not routine, notify a supervisor or the Watch Commander.
 - 5. Make reasonable attempts to locate, identify and interview all available victims, complainants, witnesses and suspects.
 - 6. Collect any evidence.
 - 7. Take any appropriate law enforcement action.
 - 8. Complete and submit the appropriate reports and documentation.
- (c) If the preliminary determination is that no crime occurred, determine what other action may be necessary, what other resources may be available, and advise the informant or complainant of this information.
- (d) The officer responsible for the initial investigation shall follow the below rules regarding closing cases in the field:

Salt Lake City Police Department

SLCPD Policy Manual

SLCPD Policy Manual

Investigation and Prosecution

- (a) If an arrest is made (citation or booked into jail) for class C or class B misdemeanors, the initial officer shall close the case in the field. The exception to this rule is for cases involving domestic violence and hate crime(s).
- (b) For all misdemeanor property crimes, misdemeanor assaults/threats, and electronic harassment reports, where viable suspect information is not available, the initial officer shall close the case in the field. The exceptions to this rule are:
 - i. Domestic violence related reports.
 - ii. Hate crime reports.
 - iii. Any misdemeanor case that the reporting officer reasonably believes may later be revised to a felony offense.
 - iv. Any felony case.
- (c) The initial officer shall close civil cases in the field. Custodial interference cases are not considered civil matters and shall not be closed in the field.
- (d) If the initial officer believes there is reason not to close any of the above listed cases in the field, they must obtain permission from their supervisor.
- (e) For cases not closed in the field, after initial reports have been submitted, it is the responsibility of the assigned follow-up detective to perform any further investigation and file any applicable charges with the appropriate prosecutor.

600.3.2 CIVILIAN MEMBER RESPONSIBILITIES

A civilian member assigned to any preliminary investigation is responsible for all investigative steps, except making any attempt to locate, contact or interview a suspect face-to-face or take any enforcement action. Should an initial investigation indicate that those steps are required, the assistance of an officer shall be requested.

600.4 CASE STATUS CONTROL SYSTEM

Upon receiving an initial report in the Records Management System (RMS) queue, the notified squad Sergeant will assign the case to a follow-up detective. Minimally, follow-up information in the RMS should include:

- (a) The follow-up detective's name
- (b) Date the case was assigned
- (c) Case number
- (d) Crime offense(s)
- (e) Other pertinent information

Upon completion of a case, the follow-up detective shall complete the Clearance Block in the report to accurately reflect the status of the case. The multiple statuses of a case are:

- (a) Open (multiple types)
- (b) Closed (multiple types)

Salt Lake City Police Department

SLCPD Policy Manual

SLCPD Policy Manual

Investigation and Prosecution

- (c) Exceptionally Cleared
- (d) Expungement
- (e) Inactive
- (f) Incomplete
- (g) Unfounded

600.5 DISCONTINUATION OF INVESTIGATIONS

The investigation of a criminal case or efforts to seek prosecution should only be discontinued if one of the following applies:

- (a) All reasonable investigative efforts have been exhausted, no reasonable belief that the person who committed the crime can be identified, and the incident has been documented appropriately.
- (b) The perpetrator of a misdemeanor has been identified and a warning is the most appropriate disposition.
 - 1. In these cases, the investigator shall document that the person was warned and why prosecution was not sought.
 - 2. Warnings shall not be given for felony offenses or other offenses identified in policy or by law that require an arrest or submission of a case to a prosecutor.
- (c) The case has been submitted to the appropriate prosecutor but no charges have been filed. Further investigation is not reasonable nor has the prosecutor requested further investigation.
- (d) The case has been submitted to the appropriate prosecutor, charges have been filed, and further investigation is not reasonable, warranted or requested, and there is no need to take the suspect into custody.
- (e) Suspects have been arrested, there are no other suspects, and further investigation is either not warranted or requested.
- (f) Investigation has proven that a crime was not committed.

600.6 MODIFICATION OF CHARGES FILED

Any request to modify charges or to recommend dismissal of charges shall be made to the assigned prosecutor.

600.7 REVISIONS

Enacted: April 9, 2018

Revised: November 8, 2018

Interrogation and Confessions

601.1 PURPOSE AND SCOPE

This policy provides general guidelines for Salt Lake City Police Department personnel to consider when dealing with interrogation and confession issues. Further guidelines regarding interrogation of juveniles can be found in the Temporary Custody of Juveniles Policy.

601.1.1 DEFINITIONS

Custody - Whether a reasonable person in the suspect's position would believe that his/her freedom was being deprived in a significant way. Custody, for purposes of interrogation, is a question of law for the court to determine, based upon what a "reasonable person" would believe. It is not determined by the subjective belief of either the officer or the suspect. It does not include routine traffic stops.

Interrogation - Words or actions that an officer should know are reasonably likely to elicit an incriminating response.

601.2 POLICY

It is the policy of this Department that all employees shall ensure compliance with applicable constitutional requirements when conducting interviews and interrogations. This includes access to counsel when an individual is entitled to counsel and counsel is requested.

601.3 FIFTH AMENDMENT RIGHTS UNDER MIRANDA

Miranda rights must be read to a person when:

- The person is in custody, **and**
- The subject is interrogated.

Miranda provides an in-custody criminal suspect with two distinct rights: the right to remain silent (refusal to answer any questions) and the right to an attorney to assist during questioning.

There are a few exceptions to this general rule with regard to when it is necessary to read a suspect their *Miranda* rights:

- During routine traffic stops.
- When asking booking questions.
- When public safety makes it imperative that the officer act as quickly as possible. Known as the "public safety exception" to *Miranda*, this rule allows an officer to question a person without *Miranda* warnings when an issue of public safety or other emergency makes it imperative to obtain information from the suspect immediately. In such a situation, immediate questioning pertaining to eliminating the danger is permitted. This exception will generally occur only at crime scenes, when the officers first arrive, the scene has not been secured, and there is an immediate danger to the public or the officers. Questions may be asked of the suspect in such a situation in order to eliminate the immediate danger.

Salt Lake City Police Department

SLCPD Policy Manual

SLCPD Policy Manual

Interrogation and Confessions

- Spontaneous statements. If a suspect makes an unsolicited statement, the statement will be admissible even though the officer has not read *Miranda* warnings, as long as the statement is not in response to interrogation or provocation.
- *Miranda* warnings need not be read prior to obtaining non-testimonial evidence, such as samples of handwriting, blood, urine, fingerprints or hair.

Officers may read *Miranda* rights directly from their rights card or may recite the rights from memory. The *Miranda* rights are:

You have the right to remain silent.

Anything you say can be used against you in a court of law.

You have the right to the presence of an attorney to assist you prior to and during questioning, if you so desire.

If you cannot afford an attorney, you have the right to have an attorney appointed for you prior to questioning.

601.3.1 WAIVER OF MIRANDA

The burden is on the officer to prove that a suspect has understood the *Miranda* rights and made a voluntary waiver of those rights.

In order to obtain a valid waiver of a suspect's *Miranda* rights, an officer must make two inquiries:

- Does the suspect understand their *Miranda* rights? **and**
- Will the suspect voluntarily answer questions?

In order to ensure that the court finds the waiver to be voluntary, officers shall:

- Not physically abuse or threaten suspects;
- Not make any promises or deals with the suspect in order to solicit any information from them during an interrogation; and
- Cease all questioning immediately upon the suspect's request to remain silent or to consult with an attorney.

Officers shall be careful in explaining the *Miranda* rights to suspects who may have trouble understanding them, such as juveniles, persons with low IQ, and persons for whom English is not their first language. If necessary, the explanation of *Miranda* rights and interrogation shall be conducted in the appropriate language other than English.

When documenting any waiver under *Miranda*, officers should record in their report all information concerning when, where, and who read the *Miranda* rights to the suspect. The officer should include in the report the exact words the suspect used when waiving his/her rights. If the suspect invokes his/her rights, the officer shall record whether the suspect invoked the right to remain silent or the right to an attorney. This is necessary so that follow-up detectives will know whether or not they can later attempt to re-*Mirandize* the suspect for interrogation.

Salt Lake City Police Department

SLCPD Policy Manual

SLCPD Policy Manual

Interrogation and Confessions

601.3.2 QUESTIONING AFTER INVOCATION

Right to Silence - If the suspect invokes the right to silence, then questioning must stop until either:

- The suspect initiates further discussion and the suspect is given Miranda warnings again and waives his or her rights; or
- There has been a sufficient break in time (at least several hours) and the suspect is given Miranda warnings again and waives his or her rights.

Right to Counsel - If the suspect invokes the right to counsel, then questioning must stop until the suspect is provided with an attorney and is given an opportunity to have the attorney present during questioning. An officer may not reinitiate questioning. The suspect may reinitiate the conversation, but before any questioning by the officer, the officer must obtain a waiver of the right to counsel.

Follow-up detectives may reapproach the suspect after consulting with the prosecuting attorney and a determined amount of time has elapsed since the suspect invoked their right to counsel.

601.4 AUDIO/VIDEO RECORDINGS

Any custodial interrogation of an individual who is suspected of having committed any violent felony offense as defined in Utah Code 76-3-203.5(1)(c)(i) should be recorded (audio, or video with audio as available) in its entirety. Regardless of where the interrogation occurs, every reasonable effort should be made to secure functional recording equipment to accomplish such recordings.

Consideration should also be given to recording a custodial interrogation for any other offense when it is reasonable to believe it would be appropriate and beneficial to the investigation and is otherwise allowed by law.

No recording of a custodial interrogation should be destroyed or altered without written authorization from the prosecuting attorney and the Investigations Division Captain. Copies of recorded interrogations or interviews may be made in the same or a different format as the original recording, provided the copies are true, accurate, and complete and are made only for authorized and legitimate law enforcement purposes.

Recordings should not take the place of a thorough report. Written statements from suspects should continue to be obtained when applicable.

The guidelines for recording a custodial interrogation are not applicable if:

- (a) The suspect refuses to speak if the interrogation is electronically recorded. Any such refusal should be documented either by audio/video recording demonstrating such refusal, or through a written statement signed by the suspect.
- (b) Despite the reasonable good faith efforts of the officer to obtain or provide recording equipment, recording equipment is not reasonably available during the period of time that the suspect is lawfully detained.

Salt Lake City Police Department

SLCPD Policy Manual

SLCPD Policy Manual

Interrogation and Confessions

- (c) The recording equipment malfunctions and replacement equipment is not reasonably available.
- (d) Despite the reasonable good faith efforts of the officer to record the interrogation, the recording equipment, without the officer's knowledge, malfunctions or stops operating.
- (e) The officer conducting the custodial interrogation reasonably believes that the crime of which the person is suspected of committing is not a violent felony offense.
- (f) Exigent circumstances render electronic recording impossible or impracticable.

601.5 CONFESSIONS

In addition to demonstrating that a criminal suspect received and waived their *Miranda* rights, the state must prove that any confession was voluntary. To prove voluntariness, the state must prove that the confession was freely given and was not the result of duress or coercion. The court will consider the physical treatment of the suspect, and any threats, promises, or “deals” made by the officer in determining whether a statement was voluntary. Officers must be particularly careful during interrogation of suspects not to engage in any conduct that may be characterized as coercing a confession from the suspect.

601.6 REVISIONS

Enacted: April 9, 2018

Sexual Assault Investigations

602.1 PURPOSE AND SCOPE

The purpose of this policy is to establish guidelines for the investigation of sexual assaults. These guidelines will address some of the unique aspects of such cases and the effects that these crimes have on the victims.

Mandatory notifications requirements are addressed in the Child Abuse and Adult Abuse policies. Taking a juvenile into protective custody is also addressed in the Child Abuse Policy.

602.1.1 DEFINITIONS

Definitions related to this policy include:

Restricted sexual assault kit - A sexual assault kit collected from a victim who is at least 18 years old and at the time of collection declines to have the kit processed or to have the examination form shared with any entity outside of the collection facility (Utah Code 76-5-602).

Sexual assault - Any crime or attempted crime of a sexual nature, to include, but not limited to, offenses defined in Utah Code, Title 76, Chapter 5, Part 4 (Sexual Offenses).

Sexual assault kit - A package of items that are used by medical personnel to gather and preserve biological and physical evidence following an allegation of sexual assault (Utah Code 76-5-602). Sexual assault kits are also referred to as Code R kits.

602.2 POLICY

It is the policy of the Salt Lake City Police Department that when responding to reports of sexual assaults, its members will strive to minimize the trauma experienced by the victims, and will investigate sexual assaults, pursue apprehension and conviction of perpetrators, and protect the safety of the victims and the community.

602.3 REPORTING

In all reported or suspected cases of sexual assault, a report shall be written and assigned for follow-up investigation. This includes incidents in which the allegations appear unfounded or unsubstantiated.

602.4 INITIAL OFFICER RESPONSIBILITIES

602.4.1 INITIAL REPORT CONSIDERATIONS

The primary considerations in sexual assault investigations, which begin with the initial call to Dispatch, should be the health and safety of the victim, the preservation of evidence, and preliminary interviews to determine if a crime has been committed and to attempt to identify the suspect.

In most cases, an in-depth follow-up interview should not be conducted until after the medical and forensic examinations are completed and the personal needs of the victim have been met. The

Salt Lake City Police Department

SLCPD Policy Manual

SLCPD Policy Manual

Sexual Assault Investigations

follow-up interview will be conducted by a Special Victims Detective, typically within a few days of the initial interview.

Victims should be apprised of applicable victim's rights provisions, as outlined in the Victim and Witness Assistance Policy. Victims reporting a sexual assault should be given the Department's Victim Information Card.

Crime lab shall be called to photograph any signs of external injuries.

If there is an identifiable crime scene, officers shall ensure that it is secured and that evidence is not lost, changed, or contaminated. Officers shall collect or ensure the collection of physical evidence. This may include but is not limited to: photographs of the scene, items touched by the suspect, bed sheets and/or clothing if applicable, and any other items deemed to have evidentiary value.

602.4.2 ADULT VICTIM INTERVIEW

Officers in charge of the initial report should consider the following:

- (a) While taking the report from the victim, the officer must remain patient, objective and non-judgmental. The officer should be neutral and impartial but needs to be compassionate and empathetic. The officer shall allow the victim to tell them what happened, without interruptions if possible. Once the narrative is received, limit questions to clarify basic information such as the site of occurrence, suspect information, and possible witnesses. It is not the officer's place to question the victim's narrative, even if it seems unreasonable and includes inconsistencies.
- (b) No opinion of whether the case is founded or unfounded should be included in the report.
- (c) It is very important to get accurate contact information for the victim, including but not limited to: home address, home phone number, mobile phone number, work phone number, and email address.
- (d) A more in-depth interview will be performed at a later time by a Special Victims Unit detective.

602.4.3 JUVENILE VICTIM INTERVIEW

There are two categories of juvenile victims for sexual assault cases. Each category is governed by guidelines for interviews as outlined below.

Category I (victims 14-17 years of age, or an 18-year-old still attending high school)

- While taking the report from the victim, the officer must remain patient, objective and non-judgmental. The officer should be neutral and impartial but needs to be compassionate and empathetic. The officer shall allow the victim to tell them what happened, without interruptions if possible. Once the narrative is received, limit questions to clarify basic information such as the site of occurrence, suspect information and possible witnesses. It is not the officer's place to question the victim's narrative, even if it seems unreasonable and includes inconsistencies.

Salt Lake City Police Department

SLCPD Policy Manual

SLCPD Policy Manual

Sexual Assault Investigations

- A Special Victim's Detective will perform a more in-depth interview at the Children's Justice Center, or in another acceptable location as determined by the investigating detective.
- It is very important to get accurate contact information for the victim and victim's parents or guardians, including but not limited to: home addresses, home phone numbers, mobile phone numbers, work phone numbers and email addresses.

Category II (victims under 14 years of age)

- Usually officers can accept hearsay information for initial reporting purposes as long as the person giving the information has had a direct conversation with the victim concerning the crime and enough information is provided to establish that a possible sexual crime has been committed.
- It is advisable that no further questioning of the victim be conducted at the time of the initial investigation. A Special Victim's Detective will perform a more in-depth interview at the Children's Justice Center, or in another acceptable location as determined by the investigating detective.
- Advise all other parties involved that it would be best they not question the victim further until after the follow-up interview.
- If the victim lives in a home where the alleged suspect also resides, both DCFS and Special Victims Unit detectives need to be notified.
- Do not allow the victim to return to a home or any place where the suspect is going to be.

602.4.4 MEDICAL EXAMINATIONS

Officers should request, if appropriate, that the victim consent to have a medical examination by a Wasatch Forensic nurse, Family Justice Center forensic nurse, or medical personnel at a hospital, with the emphasis to the importance to the victim's health, the investigation, and apprehension efforts.

If detectives have been called out and no other medical issue requires immediate treatment, then the exam should be postponed until detectives arrive and have an opportunity to speak to the victim. If the victim does not have any other medical issues that require immediate treatment, then they may choose to have their exam at a local hospital, or at the Family Justice Center.

The initial officer shall transport a victim 18 years of age or older to a hospital of their choice within Salt Lake City limits, or within a reasonable distance. The officer shall also transport the victim if they choose the Family Justice Center for their exam.

A victim under the age of 14 shall be taken to Primary Children's Medical Center. Victims age 14-17 may also be taken to PMC but have the option to have their exam at a local hospital or at the Family Justice Center. Unless they are the suspect(s), parents or guardians of these victims must sign consent forms at the hospital or give authorization to hospital personnel over the telephone for a medical exam to be performed.

Salt Lake City Police Department

SLCPD Policy Manual

SLCPD Policy Manual

Sexual Assault Investigations

Officers should have the dispatch service channel notify the hospital of estimated time of arrival and the purpose of the visit. The officer should also have Dispatch request that medical staff contact a Sexual Assault Nurse Practitioner (forensic nurse) in order to conduct a Code R examination. A forensic nurse can conduct an exam up to 120 hours from the time of the assault. They will not perform an exam on unconscious victims or victims who are unable to consent. Upon arrival, officers will verify with hospital personnel that the Rape Recovery Center has been called and has an advocate en route. If the officer has not yet done the initial interview, they are not required to wait for the advocate to arrive prior to beginning the interview.

602.4.5 CODE R KIT PROCEDURES

The forensic nurse exam may take several hours. An officer is not required to stay and wait for its completion, however, the Code R kit is police evidence and should not be left at the hospital.

The officer should notify medical personnel to call Dispatch when the Code R Kit is completed and ready to be picked up. The Kit may be picked up by an assisting officer and placed into evidence if the initial officer is not available.

The Code R kit may contain numerous items to include the Code R box with paperwork attached, and possibly urine and blood samples. There may also be clothing. Officers shall adhere to the following:

- (a) The box and clothing items shall be placed in an evidence locker. All clothing items shall be packaged separately.
- (b) Urine shall be placed in the freezer.
- (c) Blood shall be placed in the refrigerator.
- (d) The loose Code R envelope from the forensic nurse or medical personnel shall be placed in the SVU supervisor's mailbox or the SVU supervisor's office. Some Code R kits may not have this envelope, as some Code R kit reports are transmitted to the Department electronically.
- (e) Officers will include in their report the name and phone number of the forensic nurse or medical personnel who conducted the exam and the name of any other person included in the chain of evidence related to the Code R Kit.

602.4.6 RESTRICTED SEXUAL ASSAULT KIT

If a victim demands to not be interviewed, the officer should coordinate with the forensic nurse for a restricted sexual assault kit. Officers are permitted to forego interviewing victims in the event of a restricted sexual assault kit. The Code R kit may be completed without the victim being interviewed, but the victim must provide name, date-of-birth, contact address, and address of occurrence in case the victim decides to be interviewed at a later date. The circumstances surrounding the restricted sexual assault kit shall be documented in the initial report.

A victim may also request that a Code R kit not be tested.

602.4.7 DETECTIVE CALL-OUTS

A follow-up detective should be called out in the following circumstances:

Salt Lake City Police Department

SLCPD Policy Manual

SLCPD Policy Manual

Sexual Assault Investigations

- (a) All burglary sexual assaults.
- (b) If the suspect is in custody.
- (c) Child sex assaults where the suspect is in the home.
- (d) If the victim is 65 years-of-age or older or there is an indication that the victim's mental or physical condition may deteriorate rapidly as a result of the incident.
- (e) Investigations which require search warrants.
- (f) Cases where the officer or supervisor feels they need assistance. It is the officer's responsibility to discuss with their supervisor the necessity of making a request for call-out of SVU Detectives.

The request for a call-out of follow-up personnel must be made through the Watch Commander.

602.5 SPECIAL CONSIDERATIONS FOR JUVENILE VICTIMS

602.5.1 DETAINING SUSPECTED JUVENILE SEXUAL ASSAULT VICTIMS FOR AN INTERVIEW OR EXAM

An officer should not detain a child involuntarily who is suspected of being a victim of sexual assault solely for the purpose of an interview or physical exam without the consent of a parent or guardian unless one of the following applies:

- (a) Exigent circumstances exist, such as:
 - 1. A reasonable belief that medical issues of the child need to be addressed immediately.
 - 2. A reasonable belief that the child is or will be in danger of harm if the interview or physical exam is not immediately completed.
 - 3. The alleged offender is the custodial parent or guardian and there is reason to believe the child may be in continued danger.
- (b) A court order or warrant has been issued.

602.5.2 INTERVIEWS OF CHILDREN IN STATE CUSTODY

Officers should not interview a child who is in the custody of DCFS without the consent of the child's guardian ad litem. If a guardian ad litem has not been appointed, consent may be given by DCFS (Utah Code 62A-4a-415).

602.6 QUALIFIED INVESTIGATORS

Qualified investigators should be available for assignment of sexual assault investigations. These investigators should:

- (a) Have specialized training in, and be familiar with, interview techniques and the medical and legal issues that are specific to sexual assault investigations.
- (b) Conduct follow-up interviews and investigation.
- (c) Present cases of alleged sexual assault to the prosecutor for review.

Salt Lake City Police Department

SLCPD Policy Manual

SLCPD Policy Manual

Sexual Assault Investigations

- (d) Coordinate with other enforcement agencies, social service agencies, and medical personnel as needed.
- (e) Provide referrals to victim advocates.
- (f) Participate in or coordinate with the Sexual Assault Response Team (SART) or other multidisciplinary investigative teams as applicable.

602.6.1 SEXUAL ASSAULT INVESTIGATOR RESPONSIBILITIES

Detectives assigned sexual assault cases are responsible for:

- (a) Contacting victims upon assignment of the case and periodically updating the victim on the status of their case.
- (b) Contacting the victim at the conclusion of the case and informing them of the outcome.
- (c) Documenting any contacts with the victim in follow-up reports.
- (d) Ensuring investigations are done in a timely manner.
- (e) Updating the SVU supervisor regularly on any investigation requiring an extended period of time.

602.6.2 VICTIM NOTIFICATIONS

Upon request from the victim, or his/her designee, members investigating a report of an alleged sexual assault shall inform the victim or his/her designee of the following (Utah Code 77-37-3):

- (a) That the victim has the right to request a test for the HIV infection.
- (b) Whether a DNA profile was obtained from the rape kit or other evidence in his/her case.
- (c) Whether that DNA profile was entered into the Utah Combined DNA Index System (CODIS).
- (d) Whether there is a match between that DNA profile or other crime scene evidence and a DNA profile in the Utah CODIS unless such notice would impede or compromise an ongoing investigation.
- (e) That the victim has a right to designate a person to act as a recipient of the above information.
- (f) That all sexual offense victims have the right to request that a court order be issued for the suspect to submit to mandatory HIV testing. If the suspect is convicted or enters a plea of guilty, a plea of no contest or a plea of guilty and mentally ill, the results of that test must be provided to the victim. This includes both adult and juvenile offenders.
- (g) That the victim has access to free counseling and referral to support services through the Office of Crime Victims Reparations.

The provision of this information may be accomplished by hand delivering the victim one of the Department's Victim Information Cards and documenting it in the report.

602.6.3 DISPOSITION OF CASES

If the assigned investigator has reason to believe the case is without merit, the case may be classified as unfounded only upon review and approval of the Special Victims Unit supervisor.

Salt Lake City Police Department

SLCPD Policy Manual

SLCPD Policy Manual

Sexual Assault Investigations

Classification of a sexual assault case as unfounded requires the Special Victims Unit supervisor to determine that the facts have significant irregularities with reported information and that the incident could not have happened as it was reported. When a victim has recanted his/her original statement, there must be corroborating evidence that the allegations were false or baseless (i.e., no crime occurred) before the case should be determined as unfounded.

602.7 NOTIFICATION UPON ARREST

When an officer arrests a person 18 years of age or older for sexual assault, the officer shall provide the arrestee with the written notice required by Utah Code 77-20-3.5 [Salt Lake City Police Department Policy Manual: 319.4.1 JAIL RELEASE AGREEMENTS](#).

602.8 TRAINING

Subject to available resources, periodic training should be provided to:

- (a) Members who are first responders. Training should include:
 - 1. Initial response to sexual assaults.
 - 2. Legal issues.
 - 3. Victim advocacy.
 - 4. Victim's response to trauma.
- (b) Qualified investigators, who should receive advanced training on additional topics. Advanced training should include:
 - 1. Interviewing sexual assault victims.
 - 2. SART.
 - 3. Medical and legal aspects of sexual assault investigations.
 - 4. Serial crimes investigations.
 - 5. Use of community and other federal and state investigative resources, such as the Violent Criminal Apprehension Program (ViCAP).
 - 6. Techniques for communicating with victims to minimize trauma.

602.9 REVISIONS

Enacted: April 9, 2018

Revised: December 7, 2018

Asset Forfeiture

603.1 PURPOSE AND SCOPE

This policy describes the authority and procedure for the seizure, forfeiture and liquidation of property associated with specified designated offenses.

603.1.1 DEFINITIONS

Definitions related to this policy include:

Fiscal agent - The Police Financial Unit is designated by the Chief of Police to be responsible for securing and maintaining seized assets and distributing any proceeds realized from any forfeiture proceedings. This includes any time the Salt Lake City Police Department seizes property for forfeiture or when the Salt Lake City Police Department is acting as the fiscal agent pursuant to a multi-agency agreement. Refer to Police Financial Unit procedure for additional detail on the fiscal agent process.

Forfeiture - The process by which legal ownership of an asset is transferred to a government or other authority.

Forfeiture reviewer - The department member assigned by the Chief of Police, who is responsible for reviewing all forfeiture cases and for acting as the liaison between the Department and the assigned attorney.

Property subject to forfeiture - Property that has been used to facilitate the commission of a federal or state offense and any proceeds of criminal activity, including both of the following (Utah Code 24-4-102):

- (a) Real property, including things growing on, affixed to and found in land
- (b) Tangible and intangible personal property, including money, rights, privileges, interests, claims and securities of any kind

Seizure - The act of law enforcement officials taking property, cash or assets that have been used in connection with or acquired by specified illegal activities.

603.2 POLICY

The Salt Lake City Police Department recognizes that appropriately applied forfeiture laws are helpful to enforce the law, deter crime and reduce the economic incentive of crime. However, the potential for revenue should never compromise the effective investigation of criminal offenses, officer safety or any person's due process rights.

It is the policy of the Salt Lake City Police Department that all members, including those assigned to internal or external law enforcement task force operations, shall comply with all state and federal laws pertaining to forfeiture.

603.3 ASSET SEIZURE

Property may be seized for forfeiture as provided in this policy.

Salt Lake City Police Department

SLCPD Policy Manual

SLCPD Policy Manual

Asset Forfeiture

603.3.1 PROPERTY SUBJECT TO SEIZURE

- (a) Property that may be seized upon review and approval of a supervisor and in coordination with the forfeiture reviewer includes (Utah Code 24-2-102):
 - 1. Property subject to forfeiture that has been identified in a court order or is the subject of a prior judgment.
 - 2. Property subject to forfeiture that is seized incident to an arrest or upon the authority of a search or administrative warrant.
- (b) Property subject to forfeiture can be lawfully seized without a court order when:
 - 1. There is probable cause to believe it is directly or indirectly dangerous to health or safety.
 - 2. It is evidence of a crime.
 - 3. It has been used or was intended to be used to commit a crime.
 - 4. It constitutes the proceeds of a crime.

A large amount of money standing alone is insufficient to establish the probable cause required to make a seizure.

603.3.2 PROPERTY NOT SUBJECT TO SEIZURE

Property that should not be seized for forfeiture includes:

- (a) Cash and property that does not meet the forfeiture counsel's current minimum forfeiture guidelines of \$500.
- (b) Property that the officer reasonably believes may belong to an innocent owner (Utah Code 24-4-107).
- (c) A motor vehicle used in a violation of driving under the influence of alcohol and/or drugs (Utah Code 41-6a-502); driving with any measurable controlled substance in the body (Utah Code 41-6a-517); driving while having a controlled substance in the body and causing serious injury (Utah Code 58-37-8(2)(g)); automobile homicide (Utah Code 76-5-207); or a local DUI ordinance, may not be forfeited unless any of the following apply:
 - 1. The operator of the vehicle has previously been convicted of a violation, committed after May 12, 2009, of offenses specified in Utah Code 24-4-102.
 - 2. The operator of the vehicle was driving on a denied, suspended, revoked or disqualified license and the denial, suspension, revocation or disqualification was imposed based upon violations specified in Utah Code 24-4-102.
- (d) Property used to facilitate specific crimes related to pornography or material harmful to children (Utah Code 76-10-1204; Utah Code 76-10-1205; Utah Code 76-10-1206; Utah Code 76-10-1222) if the seizure would constitute a prior restraint or interference with a person's rights under the First Amendment to the U.S. Constitution or the Utah Constitution (Utah Code 24-4-102).

Salt Lake City Police Department

SLCPD Policy Manual

SLCPD Policy Manual

Asset Forfeiture

603.4 PROCESSING SEIZED PROPERTY FOR FORFEITURE

When property or cash subject to this policy is seized, the officer making the seizure should ensure compliance with the following (Utah Code 24-2-103):

- (a) Complete applicable seizure forms and present the appropriate copy to the person from whom the property is seized. If cash or property is seized from more than one person, a separate copy must be provided to each person, specifying the items seized. When property is seized and no one claims an interest in the property, the officer must leave the copy in the place where the property was found, if it is reasonable to do so.
- (b) Complete and submit a report and original seizure forms within 24 hours of the seizure, if practicable.
- (c) Forward the original seizure forms and related reports to the Forfeiture Reviewer within two days of seizure.

Photographs should be taken of items seized, particularly cash, jewelry and other valuable items.

Officers who suspect property may be subject to seizure but are not able to seize the property (e.g., the property is located elsewhere, the whereabouts of the property is unknown, it is real estate, bank accounts, non-tangible assets) should document and forward the information in the appropriate report to the Forfeiture Reviewer.

603.5 MAINTAINING SEIZED PROPERTY

The Evidence Supervisor is responsible for ensuring compliance with the following:

- (a) All property received for forfeiture is reasonably secured and properly stored to prevent waste and preserve its condition.
- (b) All property received for forfeiture is checked to determine if the property has been stolen.
- (c) All property received for forfeiture is retained in the same manner as evidence until forfeiture is finalized or the property is returned to the claimant or the person with an ownership interest.
- (d) Property received for forfeiture is not used by the Department unless the forfeiture action has been completed.
- (e) Associated documentation complies with Utah Code 24-2-103.

603.6 FORFEITURE REVIEWER

The Chief of Police will appoint a Forfeiture Reviewer. Prior to assuming duties, or as soon as practicable thereafter, the Forfeiture Reviewer should attend a course approved by the Department on asset forfeiture.

The responsibilities of the Forfeiture Reviewer include:

- (a) Remaining familiar with forfeiture laws, particularly the Forfeiture and Disposition of Property Act (Utah Code 24-1-101 et seq.) and the forfeiture policies of the forfeiture counsel.

Salt Lake City Police Department

SLCPD Policy Manual

SLCPD Policy Manual

Asset Forfeiture

- (b) Serving as the liaison between the Department and the forfeiture counsel and ensuring prompt legal review of all seizures.
- (c) Making reasonable efforts to obtain periodic training that includes best practices in pursuing, seizing and tracking forfeitures.
- (d) Reviewing each seizure-related case and deciding whether the seizure is more appropriately made under state or federal seizure laws (Utah Code 24-4-114). The Forfeiture Reviewer should contact federal authorities when appropriate.
- (e) Ensuring that responsibilities, including the designation of a fiscal agent, are clearly established whenever multiple agencies are cooperating in a forfeiture case.
- (f) Ensuring that seizure forms are available and appropriate for department use. These should include notice forms and a receipt form. The forms should contain spaces for:
 - 1. Names and contact information for all relevant persons and law enforcement officers involved.
 - 2. Information as to how ownership or other property interests may have been determined (e.g., verbal claims of ownership, titles, public records).
 - 3. A space for the signature of the person from whom cash or property is being seized.
 - 4. A tear-off portion or copy, which should be given to the person from whom cash or property is being seized, that includes the legal authority for the seizure, information regarding the process to contest the seizure and a detailed description of the items seized.
 - 5. Any other information that may be needed to comply with Utah Code 24-2-103.
- (g) Reviewing each asset forfeiture case to ensure that:
 - 1. Written documentation of the seizure and the items seized is in the case file.
 - 2. Notice of seizure has been given to those who hold an interest in the seized property within 30 days of the seizure (see Utah Code 24-4-103; Utah Code 24-4-104).
 - 3. A written request for forfeiture is presented to the prosecuting attorney no later than 60 days from the date the property was seized (Utah Code 24-4-103).
 - 4. Property is promptly released to those entitled to its return.
 - 5. Any cash received is deposited with the fiscal agent.
 - 6. Assistance with the resolution of ownership claims and the release of property to those entitled is provided.
 - 7. Current minimum forfeiture thresholds are communicated appropriately to officers.
 - 8. This policy and any related policies are periodically reviewed and updated to reflect current federal and state statutes and case law.

Salt Lake City Police Department

SLCPD Policy Manual

SLCPD Policy Manual

Asset Forfeiture

9. A copy of the property receipt is kept in the case file and, if the property is transferred to another agency, a copy of the receipt is provided along with the property (Utah Code 24-2-103).
 10. Any records of a related interview of a child are retained pursuant to Utah Code 24-2-103.
 11. The request a forfeiture action be commenced by the forfeiture attorney as provided in Utah Code 24-4-103.
- (h) Ensuring that the Department disposes of property as provided by law following any forfeiture.

Forfeiture proceeds should be maintained in a separate fund or account subject to appropriate accounting control, with regular reviews or audits of all deposits and expenditures.

Forfeiture reporting and expenditures should be completed in the manner prescribed by the law and City financial directives. The Utah Code 24-4-118 should be referenced for reporting federal seizures to the Utah Commission on Criminal and Juvenile Justice.

603.7 DISPOSITION OF FORFEITED PROPERTY

No property seized shall be transferred, sold or auctioned to an employee of this department (Utah Code 24-2-103).

No member of this department may use property that has been seized for forfeiture until the forfeiture action has been completed and the Chief of Police has given written authorization to retain the property for official use. No department member involved in the decision to seize property should be involved in any decision regarding the disposition of the property.

Any property, money or other items of value received by this department pursuant to a federal forfeiture shall be used in compliance with federal laws and regulations relating to equitable sharing (Utah Code 24-4-114). Such property may be used to fund crime prevention and law enforcement activities described in Utah Code 24-4-117(9). State law prohibits the use of property or money received to be used for such things as salaries, benefits, any expenses not related to law enforcement and other purposes specified in Utah Code 24-4-117(10).

Money received as a result of a federal forfeiture may only be used as approved by the City council (Utah Code 24-4-114).

603.8 LIMITATION ON FEES FOR HOLDING SEIZED PROPERTY

The Department will not charge a person contesting a forfeiture any fee or cost for holding seized property as the result of any civil or criminal forfeiture in which a judgment is entered in favor of the person, or where a forfeiture proceeding is voluntarily dismissed by the prosecuting attorney (Utah Code 24-4-112).

603.9 FEDERAL ASSET SHARING

The Forfeiture Reviewer will follow state and federal law, as well as unit procedures regarding federal asset sharing.

Salt Lake City Police Department

SLCPD Policy Manual

SLCPD Policy Manual

Asset Forfeiture

There are two ways the Department may qualify for Federal Asset sharing:

1. **Joint Investigations** - When the Department participates in an investigation with a federal agency to enforce federal criminal laws which provide for forfeiture.
2. **Adoption** - When the Department, acting without any federal participation, confiscates property as a result of enforcing a federal law which provides for forfeiture, the Department may request that the appropriate federal agency, which normally enforces the law, “adopt” the seizure and implement federal forfeiture procedures.

603.10 FORFEITURE REVIEWER EXTENDED ABSENCE PLAN

In the event that the Forfeiture Reviewer is absent for an extended period of time, the Narcotics Sergeant will fill the Forfeiture Reviewer role and assume all responsibilities of the Forfeiture Reviewer. The Narcotics Sergeant will also become the point of contact for the department for the District Attorney's Office on cases involving asset forfeitures until the return of the Forfeiture Reviewer.

603.11 ASSET FORFEITURE PROCEDURES

Refer to the Asset Forfeiture Procedure for specific procedural actions by type of Unit and type of asset.

[Salt Lake City Police Department Procedure Manual: 600.2.1 FIELD UNIT PROCEDURE](#)

[Salt Lake City Police Department Procedure Manual: 600.2.2 INVESTIGATIVE UNIT PROCEDURE](#)

[Salt Lake City Police Department Procedure Manual: 600.2.3 IMPOUNDMENT OF VEHICLES SEIZED FOR FORFEITURE](#)

[Salt Lake City Police Department Procedure Manual: 600.2.4 SEIZURE OF MONIES, NEGOTIABLE INSTRUMENTS, AND SECURITIES FOR FORFEITURE](#)

[Salt Lake City Police Department Procedure Manual: 600.2.5 SEIZURE OF REAL PROPERTY](#)

603.12 REVISIONS

Enacted: April 9, 2018

Informants

604.1 PURPOSE AND SCOPE

The purpose of this policy is to provide guidelines for the use of informants.

604.1.1 DEFINITIONS

Definitions related to this policy include:

Informant - A person who covertly interacts with other individuals or suspects at the direction of, request of, or by agreement with the Salt Lake City Police Department for law enforcement purposes. This also includes a person agreeing to supply information to the Salt Lake City Police Department for a benefit (e.g., a quid pro quo in the form of a reduced criminal penalty, money, etc.).

604.2 POLICY

The Salt Lake City Police Department recognizes the value of informants to law enforcement efforts and will strive to protect the integrity of the informant process. It is the policy of this department that all funds related to informant payments will be routinely audited and that payments to informants will be made according to the criteria outlined in this policy.

604.3 USE OF INFORMANTS

All informants are assets of the Salt Lake City Police Department rather than a specific controlling investigator. If a supervisor determines that an informant could be better utilized by another investigator, group, or unit, the control of the informant will be transferred.

604.3.1 INITIAL APPROVAL

Before using an individual as an informant, an officer must receive approval from his/her supervisor. The officer shall compile sufficient information through a background investigation and experience with the informant in order to determine the suitability of the individual, including age, maturity and risk of physical harm, as well as any indicators of his/her reliability and credibility.

Members of this department should not guarantee absolute safety or confidentiality to an informant.

604.3.2 JUVENILE INFORMANTS

The use of juvenile informants under the age of 13-years is prohibited.

In all cases, a juvenile 13 years of age or older may only be used as an informant with the written consent of each of the following:

- (a) The juvenile's parents or legal guardians
- (b) The juvenile's attorney, if any
- (c) The court in which the juvenile's case is being handled, if applicable
- (d) The Chief of Police or the authorized designee

Salt Lake City Police Department

SLCPD Policy Manual

SLCPD Policy Manual

Informants

604.3.3 INFORMANT AGREEMENTS

All informants are required to sign and abide by the provisions of the designated department informant agreement. The officer using the informant shall discuss each of the provisions of the agreement with the informant.

Details of the agreement are to be approved in writing by a supervisor before being finalized with the informant.

604.3.4 APPROVAL OF NEW INFORMANTS - PROCESS AND RESPONSIBILITIES

[Salt Lake City Police Department Procedure Manual: 601.2 APPROVAL OF NEW INFORMANTS - PROCESS AND RESPONSIBILITIES](#)

604.4 INFORMANT FILES

Informant files shall be utilized as a source of background information about the informant, to enable review and evaluation of information provided by the informant, and to minimize incidents that could be used to question the integrity of department members or the reliability of the informant.

Informant files shall be maintained in a secure area only within the Narcotics Unit. The Narcotics Unit supervisor or the authorized designee shall be responsible for maintaining informant files. Access to the informant files shall be restricted to the Narcotics Unit supervisor and their authorized designees.

The Division Commander over Narcotics should arrange with the Narcotics Unit supervisor for an audit using a representative sample of randomly selected informant files on a periodic basis, but no less than one time per year. If the Narcotics Unit supervisor is replaced, the files will be audited before the new supervisor takes over management of the files. The purpose of the audit is to ensure compliance with file content and updating provisions of this policy. The audit should be conducted by a supervisor who does not have normal access to the informant files.

604.5 INFORMANT INTEGRITY

To maintain the integrity of the informant process, the following must be adhered to:

- (a) The identity of an informant acting in a confidential capacity shall not be withheld from the Chief of Police, Division Commander, Narcotics Unit supervisor or their authorized designees.
 - 1. Identities of informants acting in a confidential capacity shall otherwise be kept confidential.
- (b) Criminal activity by informants shall not be condoned.
- (c) Informants shall be told they are not acting as police officers, employees or agents of the Salt Lake City Police Department, and that they shall not represent themselves as such.
- (d) The relationship between department members and informants shall always be ethical and professional.

Salt Lake City Police Department

SLCPD Policy Manual

SLCPD Policy Manual

Informants

- (a) Members shall not become intimately involved with an informant.
- (b) Social contact shall be avoided unless it is necessary to conduct an official investigation, and only with prior approval of the Narcotics Unit supervisor.
- (c) Members shall neither solicit nor accept gratuities or engage in any private business transaction with an informant.
- (e) At least two Officers will be present at all meetings with informants.
- (f) In all instances when department funds are paid to informants, a voucher shall be completed in advance, itemizing the expenses.
- (g) Since the decision rests with the appropriate prosecutor, officers shall not promise that the informant will receive any form of leniency or immunity from criminal prosecution.
- (h) If an informant is an acquaintance, family member, or friend of an officer, that officer shall never be the controlling officer of the informant.
- (i) All informants and their property will be thoroughly searched both before and after participating in a controlled purchase of narcotics or other investigative activity.
- (j) An informant will not be permitted to carry a firearm or other weapon during undercover meetings, even if the informant has been issued a concealed carry permit.
- (k) An informant's controlling officer shall inform the informant that working with other agencies while they are working with the Salt Lake City Police Department will not be allowed.
- (l) When an informant is providing and/or gathering information for the Salt Lake City Police Department, the controlling officer will always keep the safety/welfare of the informant in mind.

604.5.1 UNSUITABLE INFORMANTS

The suitability of any informant should be considered before engaging him/her in any way in a covert or other investigative process. Members who become aware that an informant may be unsuitable will notify their supervisor, who will initiate a review to determine suitability. Until a determination has been made by a supervisor, the informant should not be used by any member. The supervisor shall determine whether the informant should be used by the Department and, if so, what conditions will be placed on his/her participation or any information the informant provides. The supervisor shall document the decision and conditions in file notes and mark the file "unsuitable" when appropriate.

[Salt Lake City Police Department Procedure Manual: 601.3 UNSUITABLE INFORMANTS](#)

604.6 INFORMANT PAYMENTS

No informant will be told in advance or given an exact amount or percentage for his/her service. The amount of funds to be paid to any informant will be evaluated against the following criteria:

- The extent of the informant's personal involvement in the case
- The significance, value or effect on crime

Salt Lake City Police Department

SLCPD Policy Manual

SLCPD Policy Manual

Informants

- The value of assets seized
- The quantity of the drugs or other contraband seized
- The level of risk taken by the informant

[Salt Lake City Police Department Procedure Manual: 601.4.1 INFORMANT PAYMENTS](#)

604.6.1 AUDIT OF PAYMENTS

The designated supervisor responsible for controlling disbursements of a particular unit or division to an informant, or their authorized designee, shall be responsible for compliance with any audit requirements associated with grant provisions and applicable state and federal law.

[Salt Lake City Police Department Procedure Manual: 601.5 AUDIT PROCEDURES](#)

604.7 REVISIONS

Enacted: April 9, 2018

Eyewitness Identification

605.1 PURPOSE AND SCOPE

This policy sets forth guidelines to be used when members of this department employ eyewitness identification techniques.

605.1.1 DEFINITIONS

Definitions related to the policy include:

Eyewitness identification process - Any field identification, live lineup or photographic identification.

Field identification - A live presentation of a single individual to a witness following the commission of a criminal offense for the purpose of identifying or eliminating the person as the suspect.

Live lineup - A live presentation of individuals to a witness for the purpose of identifying or eliminating an individual as the suspect.

Photographic lineup - Presentation of photographs to a witness for the purpose of identifying or eliminating an individual as the suspect.

605.2 POLICY

The Salt Lake City Police Department will strive to use eyewitness identification techniques, when appropriate, to enhance the investigative process and will emphasize identifying persons responsible for crime and exonerating the innocent.

605.3 INTERPRETIVE SERVICES

Members should make a reasonable effort to arrange for an interpreter before proceeding with eyewitness identification if communication with a witness is impeded due to language or hearing barriers.

Before the interpreter is permitted to discuss any matter with the witness, the investigating member should explain the identification process to the interpreter. Once it is determined that the interpreter comprehends the process and can explain it to the witness, the eyewitness identification may proceed as provided for within this policy.

605.4 EYEWITNESS IDENTIFICATION

Members are cautioned not to, in any way, influence a witness as to whether any subject or photo presented in a lineup is in any way connected to the case. Members should avoid mentioning that:

- The individual was apprehended near the crime scene.
- The evidence points to the individual as the suspect.
- Other witnesses have identified, or failed to identify, the individual as the suspect.

Salt Lake City Police Department

SLCPD Policy Manual

SLCPD Policy Manual

Eyewitness Identification

In order to avoid undue influence, witnesses should view suspects or a lineup individually and outside the presence of other witnesses. Witnesses should be instructed to avoid discussing details of the incident or of the identification process with other witnesses.

Whenever feasible, the eyewitness identification procedure should be audio and/or video recorded and the recording should be retained according to current evidence procedures.

605.4.1 PHOTOGRAPHIC LINEUP AND LIVE LINEUP CONSIDERATIONS

When practicable, the member presenting the lineup should not be involved in the investigation of the case or know the identity of the suspect. In no case should the member presenting a lineup to a witness know which photograph or person in the lineup is being viewed by the witness. Techniques to achieve this include randomly numbering photographs, shuffling folders or using a computer program to order the persons in the lineup.

Individuals in the lineup should reasonably match the description of the perpetrator provided by the witness and should bear similar characteristics to avoid causing any person to unreasonably stand out. In cases involving multiple suspects, a separate lineup should be conducted for each suspect. The suspects should be placed in a different order within each lineup.

The member presenting the lineup should do so sequentially (i.e., show the witness one person at a time) and not simultaneously. The witness should view all persons in the lineup.

A live lineup should only be used before criminal proceedings have been initiated against the suspect. If there is any question as to whether any criminal proceedings have begun, the investigating member should contact the appropriate prosecuting attorney before proceeding.

605.4.2 FIELD IDENTIFICATION CONSIDERATIONS

Field identifications, also known as field elimination show-ups or one-on-one identifications, may be helpful in certain cases, where exigent circumstances make it impracticable to conduct a photo or live lineup identifications. A field elimination show-up or one-on-one identification should not be used when independent probable cause exists to arrest a suspect. In such cases a live or photo lineup is the preferred course of action if eyewitness identification is contemplated.

When initiating a field identification, the officer should observe the following guidelines:

- (a) Obtain a complete description of the suspect from the witness.
- (b) Assess whether a witness should be included in a field identification process by considering:
 1. The length of time the witness observed the suspect.
 2. The distance between the witness and the suspect.
 3. Whether the witness could view the suspect's face.
 4. The quality of the lighting when the suspect was observed by the witness.
 5. Whether there were distracting noises or activity during the observation.

Salt Lake City Police Department

SLCPD Policy Manual

SLCPD Policy Manual

Eyewitness Identification

6. Any other circumstances affecting the witness's opportunity to observe the suspect.
 7. The length of time that has elapsed since the witness observed the suspect.
- (c) If safe and practicable, the person who is the subject of the show-up should not be handcuffed or in a patrol vehicle.
 - (d) When feasible, members should bring the witness to the location of the subject of the show-up, rather than bring the subject of the show-up to the witness.
 - (e) The person who is the subject of the show-up should not be shown to the same witness more than once.
 - (f) In cases involving multiple suspects, witnesses should only be permitted to view the subjects of the show-up one at a time.
 - (g) The person who is the subject of the show-up should not be required to put on clothing worn by the suspect, to speak words uttered by the suspect or to perform other actions mimicking those of the suspect.
 - (h) If a witness positively identifies a subject of a show-up as the suspect, members should not conduct any further field identifications with other witnesses for that suspect. In such instances members should document the contact information for any additional witnesses for follow up, if necessary.

605.5 DOCUMENTATION

A thorough description of the eyewitness process and the results of any eyewitness identification should be documented in the case report.

If a photographic lineup is utilized, a copy of the photographic lineup presented to the witness should be included in the case report. In addition, the order in which the photographs were presented to the witness should be documented in the case report.

605.6 REVISIONS

Enacted: April 9, 2018

Brady Material Disclosure

606.1 PURPOSE AND SCOPE

This policy establishes guidelines for identifying and releasing potentially exculpatory or impeachment information (so-called “*Brady* information”) to a prosecuting attorney.

606.1.1 DEFINITIONS

Definitions related to this policy include:

Brady information - Information known or possessed by the Salt Lake City Police Department that is both favorable and material to the current prosecution or defense of a criminal defendant.

606.2 POLICY

The Salt Lake City Police Department will conduct fair and impartial criminal investigations and will provide the prosecution with both incriminating and exculpatory evidence, as well as information that may adversely affect the credibility of a witness. In addition to reporting all evidence of guilt, the Salt Lake City Police Department will assist the prosecution by complying with its obligation to disclose information that is both favorable and material to the defense. The Department will identify and disclose to the prosecution potentially exculpatory information, as provided in this policy.

606.3 DISCLOSURE OF INVESTIGATIVE INFORMATION

Officers must include in their investigative reports adequate investigative information and reference to all material evidence and facts that are reasonably believed to be either incriminating or exculpatory to any individual in the case. If an officer learns of potentially incriminating or exculpatory information any time after submission of a case, the officer or the handling investigator must prepare and submit a supplemental report documenting such information as soon as practicable. Supplemental reports shall be promptly processed and transmitted to the prosecutor’s office.

If information is believed to be privileged or confidential (e.g., confidential informant or protected personnel files), the officer should discuss the matter with a supervisor and/or prosecutor to determine the appropriate manner in which to proceed.

Evidence or facts are considered material if there is a reasonable probability that they would affect the outcome of a criminal proceeding or trial. Determining whether evidence or facts are material often requires legal or even judicial review. If an officer is unsure whether evidence or facts are material, the officer should address the issue with a supervisor.

Supervisors who are uncertain about whether evidence or facts are material should address the issue in a written memo to an appropriate prosecutor. A copy of the memo should be retained in the Department case file.

606.4 DISCLOSURE OF PERSONNEL INFORMATION

Utah Rules of Evidence 608 and 609 identify four types of evidence that are admissible to question a witness’s credibility:

Salt Lake City Police Department

SLCPD Policy Manual

SLCPD Policy Manual

Brady Material Disclosure

1. A witness's reputation for untruthfulness;
2. Specific instances of a witness's conduct that are probative of his or her character for untruthfulness;
3. Evidence of bias, prejudice, or any motive to misrepresent; and
4. Convictions for felonies and crimes of dishonesty.

The Salt Lake County District Attorney's Office (DAO) has designed a protocol and questionnaire for providing relevant *Brady* information. Since any Department employee may be subpoenaed to court, all employees shall complete the *Brady* questionnaire by following proper procedure. [Salt Lake City Police Department Procedure Manual: 602.2 SUBMITTING A BRADY QUESTIONNAIRE](#)

Once Department employees have answered and submitted the *Brady* questionnaire, the DAO *Brady* Coordinator will review the questionnaires for any possible *Brady* material. This is a two-step process:

1. The *Brady* Coordinator will determine if the information is in fact *Brady*-related.
2. If the information is determined to be *Brady*-related, the *Brady* Coordinator will determine if the information is material to a specific case.

The discoverability of *Brady* material will be made on a case-by-case basis.

606.5 REVISIONS

Enacted: April 9, 2018

Pawn Shop Holds

607.1 PURPOSE AND SCOPE

Property with evidentiary value is often found at pawn shops and secondhand businesses. Utah law allows the Salt Lake City Police Department to seize or place a hold on such property. This policy provides guidance on placing such holds.

607.2 POLICY

The Salt Lake City Police Department will place a hold on an item that has evidentiary value and is in the possession of a pawn or secondhand business only as allowed by Utah law and when the item is necessary to an open investigation.

607.3 HOLDS AND SEIZURES

607.3.1 HOLDS

A member of the Department may require a pawnbroker or secondhand business to place a 90-day hold on an item in the possession of the pawnbroker or secondhand business if the item is necessary to an open investigation. The hold may be extended for an additional 90 days if warranted by exigent circumstances. Subsequent extensions must be approved by a court order (Utah Code 13-32a-109).

To place an item on hold, the proper procedure will be followed. [Salt Lake City Police Department Procedure Manual: 603.2 PAWN SHOP HOLDS - PROCEDURE](#)

607.3.2 SEIZURES

An officer may seize an item when exigent circumstances exist or when necessary during the course of a criminal investigation. Items may also be seized (Utah Code 13-32a-109.5; Utah Code 13-32a-115(2)):

- (a) When seizure is necessary to permit the fingerprinting or chemical testing of the item.
- (b) If the item contains unique or sensitive personal identifying information.

When field officers are determining whether to seize an item, rather than placing a hold on it, generally, unless the item is an electronic device containing personal information, a hold should be placed rather than a seizure being conducted. If circumstances exist that lead an officer to believe another type of item should be seized rather than having a hold placed on it, the officer should consult with their supervisor.

To seize an item from a pawnbroker or secondhand business, the proper procedure will be followed. [Salt Lake City Police Department Procedure Manual: 603.3 PAWN SHOP SEIZURES](#)

607.4 JURISDICTIONAL ISSUES

If an officer responds to a call for service in the City where an item in question at a pawn shop or secondhand business was reportedly stolen in another jurisdiction, the officer shall initiate a

Salt Lake City Police Department

SLCPD Policy Manual

SLCPD Policy Manual

Pawn Shop Holds

report and place a hold on or seize the item(s) (whichever is appropriate) provided the officer is satisfied that the standards for such actions have been met. All questions of prosecutorial and investigative jurisdiction will be resolved by follow-up investigators.

If through investigation an officer determines an item at a pawnbroker or secondhand business located outside the jurisdiction of this Department needs to be placed on hold, normal procedures for placing the item on hold will be followed. In addition, a copy of the hold notice shall be sent to the law enforcement agency having jurisdiction (Utah Code 13-32a-109).

607.5 TERMINATION OF HOLD

The Department's Pawn Technician will maintain a file copy of all hold notices and should review the file at least every 30 days for pending expirations. When the need for the hold or seizure of an item is terminated and no original victim was located, the Department shall, within 15 business days after the termination (Utah Code 13-32a-109(7)):

- (a) Notify the pawnbroker or secondhand business in writing that the hold or seizure has been terminated.
- (b) Return the item to the pawnbroker or secondhand business, or advise the pawnbroker or secondhand business, either in writing or electronically, of the specific alternative disposition of the item.

If an original victim was located, the release of the property shall only be made with the consent of the appropriate prosecutor and with notices made according to Utah Code 13-32a-109(8).

If this Department receives a registered or certified letter from the pawnbroker or secondhand business informing the Department that the holding period has expired, the Department shall respond within 30 days in the manner prescribed by law (Utah Code 13-32a-109(9)).

607.6 TRAINING

The Property Crimes Lieutenant should ensure that the designated Pawn Detective receives, at a minimum, two hours annual compliance training related to property held by pawn shops and secondhand businesses (Utah Code 13-32a-112(9)).

607.7 REVISIONS

Enacted: April 9, 2018

Revised: June 29, 2020

Warrant Service

608.1 PURPOSE AND SCOPE

This policy establishes guidelines for the planning and serving of arrest and search warrants by members of this Department. It is understood that this policy cannot address every variable or circumstance that can arise in the service of a search or arrest warrant, as these tasks can involve rapidly evolving and unique circumstances.

This policy is intended to be used in conjunction with the Operations Planning and Deconfliction Policy, which has additional guidance on planning and serving high-risk warrants.

This policy is not intended to address the service of search warrants on locations or property already secured or routine field warrant arrests by patrol officers.

608.1.1 DEFINITIONS

Definitions related to this policy include:

Reportable incident - An incident where forcible entry is used or a special unit specifically trained and equipped to respond to critical, high-risk situations is deployed in the service of a search warrant (Utah Code 77-7-8.5).

608.2 POLICY

It is the policy of the Salt Lake City Police Department to balance the safety needs of the public, the safety of department members, privacy interests and other relevant factors when making decisions related to the service of search and arrest warrants.

608.3 TACTICAL COMMANDER

The Tactical Commander or designee shall review all risk assessment forms with the involved supervisor to determine the risk level of the warrant service.

SWAT shall serve all search warrants for the Department when the search warrant is for an unsecured location. An unsecured location is defined as any building or area to be searched that may have unsecured person(s) within. Officers will also complete the risk assessment matrix and submit it, along with the warrant affidavit, to the appropriate supervisor and the Tactical Commander for review and classification of risk (see the Operations Planning and Deconfliction Policy).

Proper procedure shall be followed in completing the risk assessment matrix, and the Tactical Commander or designee will determine the manner of service based, in part, on the risk assessment. [Salt Lake City Police Department Procedure Manual: 604.2 RISK ASSESSMENT MATRIX](#)

Deconfliction, operational planning, briefing and debriefing should follow guidelines in the Operations Planning and Deconfliction Policy.

Salt Lake City Police Department

SLCPD Policy Manual

SLCPD Policy Manual

Warrant Service

608.3.1 REPORTING REQUIREMENTS

The Tactical Commander or designee shall ensure that reports of all warrants served by SWAT in the prior year are submitted to the Records Unit by February 1 of each year via the RMS Law Enforcement Transparency Template and/or an After Action Report. Supervisors of officers serving a warrant where forcible entry was used, but SWAT was not utilized, shall be responsible for ensuring reporting compliance with the state requirements by submitting the RMS Law Enforcement Transparency Template for each such instance.

The Records Unit shall compile the information and forward a final report in the format developed by the Commission on Criminal and Juvenile Justice (CCJJ), as required by Utah Code 77-7-8.5, to the Chief of Police.

The Chief of Police shall review and approve the report and ensure that it is forwarded to the CCJJ and the designated recipient for the City no later than April 30.

608.4 SEARCH WARRANTS

Officers will prepare the affidavit and search warrant. All search warrants (with the exception of those obtained for blood in order to measure possible impairment) must be reviewed by an attorney from the Salt Lake County District Attorney's Office (DAO) prior to being sent to a magistrate for approval. Proper DAO review procedure shall be followed. [Salt Lake City Police Department Procedure Manual: 604.3 DISTRICT ATTORNEY SEARCH WARRANT REVIEW](#)

608.5 ARREST WARRANTS

If an officer reasonably believes that serving an arrest warrant may pose a higher risk than commonly faced on a daily basis, the officer should complete the risk assessment matrix and submit it to the appropriate supervisor and the Tactical Commander for review and classification of risk.

If the warrant is classified as high risk, service will be coordinated by the Tactical Commander or designee. If the warrant is not classified as high risk, the supervisor should weigh the risk of entry into a residence to make an arrest against other alternatives, such as arresting the person outside the residence where circumstances may pose a lower risk.

608.5.1 TIME AND PLACE ARRESTS MAY BE MADE

- (a) An arrest pursuant to a felony arrest warrant may be made at any time of the day or night.
- (b) An arrest pursuant to a misdemeanor arrest warrant may be made at night only if:
 - i. The magistrate has endorsed authorization to do so on the warrant.
 - ii. The person to be arrested is upon a public highway or in a public place or a place open to or accessible to the public.
 - iii. The person to be arrested is encountered by a peace officer in the regular course of that peace officer's investigation of a criminal offense unrelated to the misdemeanor warrant for arrest.

Salt Lake City Police Department

SLCPD Policy Manual

SLCPD Policy Manual

Warrant Service

- (c) Daytime hours under Utah law are the hours of 6:00 a.m. to 10:00 p.m. and nighttime hours are the hours after 10:00 p.m. and before 6:00 a.m.

608.6 WARRANT PREPARATION

An officer who prepares a warrant shall ensure the documentation in support of the warrant contains as applicable:

- (a) Probable cause to support the search or arrest, including relevant dates and times to demonstrate timeliness and facts to support any request for nighttime or no-knock warrant execution (Utah Code 77-7-8.1).
- (b) A clear explanation of the affiant's training, experience and relevant education.
- (c) Adequately supported opinions, when relevant, that are not left to unsubstantiated conclusions.
- (d) A nexus between the place to be searched and the persons or items central to the investigation. The facts supporting this nexus should be clear and current. For example, the affidavit shall explain why there is probable cause to believe that a particular person is currently residing at a particular location or that the items sought are present at a particular location.
- (e) A specific description of the location to be searched.
- (f) A sufficient description of the items to be seized.

608.6.1 WARRANTS UTILIZING AN UNMANNED AIRCRAFT SYSTEM (UAS)

Warrants that are being prepared with the expectation to use an unmanned aircraft system shall use the language found in procedure 607.7 UNMANNED AIRCRAFT SEARCH WARRANT LANGUAGE.

608.7 HIGH-RISK WARRANT SERVICE

The Tactical Commander or the authorized designee shall coordinate the service of warrants that are categorized as high risk and shall have sole authority in determining the manner in which the warrant will be served, including the number of officers deployed.

The member responsible for directing the service should ensure the following as applicable:

- (a) All personnel engaged in a pre-planned high-risk situation shall be required to wear appropriate protective gear including protective vests.
- (b) The warrant service is audio- and video-recorded when practicable and reasonable to do so.
 - (a) Members executing a warrant shall wear a body-worn camera unless exigent circumstances make the use of such a camera impracticable (Utah Code 77-23-210).
- (c) Evidence is handled and collected only by those members who are designated to do so. All other members involved in the service of the warrant should alert one of the designated members to the presence of potential evidence and not touch or disturb the items.

Salt Lake City Police Department

SLCPD Policy Manual

SLCPD Policy Manual

Warrant Service

- (d) Persons who are detained as part of the search warrant service are handled appropriately under the circumstances.
- (e) Reasonable care provisions are made for children and dependent adults (see the Child and Dependent Adult Safety Policy).
- (f) If the use of an imaging surveillance device is requested, the application must include a description of the capabilities of the device and the measures that the officers will take to avoid the device being used in a manner beyond the scope of the warrant (Utah Code 77-23d-103).
- (g) Absent exigent circumstances, officers serving a search warrant shall wear a uniform or other clothing that clearly identifies them as law enforcement, including a badge and law enforcement label (Utah Code 77-23-210; Utah Code 77-7-8; Utah Code 77-7-8.1).

608.7.1 NO-KNOCK ENTRIES

Officers may execute a warrant without notice of the authority and purpose only if (Utah Code 77-23-210; Utah Code 77-7-6; Utah Code 77-7-8; Utah Code 77-7-8.1):

- (a) A no-knock warrant has been issued.
- (b) There is reasonable suspicion to believe that the notice will endanger the life or safety of the officer or another person.
- (c) There is probable cause to believe that evidence may be easily or quickly destroyed.
- (d) There is reason to believe that the notice will enable the escape of a person to be arrested.
- (e) The person to be arrested is engaged in the commission or attempted commission of an offense or has been pursued immediately after the commission of an offense or an escape.

608.8 DETENTIONS DURING WARRANT SERVICE

Officers must be sensitive to the safety risks of all persons involved with the service of a warrant. Depending on circumstances and facts present, it may be appropriate to control the movements of any or all persons present at a warrant service, who may not be the subject of a warrant or suspected in the case. However, officers must be mindful that only reasonable force may be used (see the Use of Force Policy).

As soon as it can be determined that an individual is not subject to the scope of a warrant and that no further reasonable suspicion or safety concerns exist to justify further detention, the person should be promptly released.

Officers should, when and to the extent reasonable, accommodate the privacy and personal needs of the people who have been detained.

608.9 ACTIONS AFTER WARRANT SERVICE

The authoring officer of a search warrant shall ensure that all affidavits, warrants, receipts and returns, regardless of any associated cases, are filed with the issuing judge or magistrate as soon as reasonably possible, but in any event no later than any date specified on the warrant.

Salt Lake City Police Department

SLCPD Policy Manual

SLCPD Policy Manual

Warrant Service

608.9.1 PROPERTY

If the possessor of the property is absent at the time of the search, the premises or other property must be secured upon completion of the search.

A detailed receipt for any property seized must be given to its possessor, or left where the property was found or seized, if no responsible person is present to take the receipt.

A written inventory of the property seized pursuant to the warrant must be included with the warrant's return of service.

608.9.2 NOTIFICATIONS REGARDING USE OF IMAGING SURVEILLANCE DEVICE

When an imaging surveillance device is used during the service of a warrant, notification shall be made to the person who owns or otherwise resides at the location specified in the warrant within 14 days unless a court-ordered extension has been granted (Utah Code 77-23d-104).

An imaging surveillance device is defined as a device that uses radar, sonar, infrared, or other remote sensing or detection technology used by the individual operating the device to obtain information, not otherwise directly observable, about individuals, items, or activities within a closed structure (Utah Code 77-23d-102(2)).

608.10 OUTSIDE AGENCIES AND CROSS-JURISDICTIONAL WARRANTS

The Tactical Commander will ensure that cooperative efforts with other agencies in the service of warrants conform to existing mutual aid agreements or other memorandums of understanding and will work cooperatively to mitigate risks including, but not limited to, the following:

- Identity of team members
- Roles and responsibilities
- Familiarity with equipment
- Rules of engagement

Any outside agency requesting assistance in the service of a warrant within this jurisdiction should be referred to the Tactical Commander or Watch Commander. The Tactical Commander or Watch Commander should confirm the warrant location, and should discuss the service with the appropriate supervisor from the other agency. The Tactical Commander or Watch Commander should ensure that members of the Salt Lake City Police Department are utilized appropriately. Any concerns regarding the requested use of Salt Lake City Police Department members should be brought to the attention of the Chief of Police or the authorized designee. The actual service of the warrant will remain the responsibility of the agency requesting assistance.

If officers intend to serve a warrant outside Salt Lake City Police Department jurisdiction, the Tactical Commander should provide reasonable advance notice to the applicable agency, request assistance as needed, and work cooperatively on operational planning and the mitigation of risks detailed in this policy.

Salt Lake City Police Department

SLCPD Policy Manual

SLCPD Policy Manual

Warrant Service

Officers will remain subject to the policies of the Salt Lake City Police Department when assisting outside agencies or serving a warrant outside the Salt Lake City Police Department jurisdiction.

608.11 MEDIA ACCESS

No advance information regarding warrant service operations shall be released without the approval of the Chief of Police. Any media inquiries or press release after the fact shall be handled in accordance with the Media Relations Policy.

608.12 REVISIONS

Enacted: April 9, 2018

Revised: July 5, 2022

Operations Planning and Deconfliction

609.1 PURPOSE AND SCOPE

This policy provides guidelines for planning, deconfliction, and execution of operations such as search warrants, stings, and high-risk arrest warrant service. The policy also covers the risk mitigation process that should be a part of these activities. This policy is not intended to address the service of search warrants on locations or property already secured, or routine field warrant arrests by patrol officers.

609.1.1 DEFINITIONS

Definitions related to this policy include:

Deconfliction - A centralized process that allows for the collection of operations and case information and that provides alerts to enhance safety and avoid duplication or confliction of operations.

Reportable incident - When law enforcement officers use forcible entry to serve a search warrant, or when a special unit that is specifically trained and equipped to respond to critical, high-risk situations within either the Department or an assisting department is deployed (Utah Code 77-7-8.5).

609.2 POLICY

It is the policy of the Salt Lake City Police Department to properly plan and execute large scale and high-risk operations. Proper planning and execution enable effective coordination of such operations. The SLCPD will participate in a regional deconfliction system that is designed to enhance the safety of officers and the public, to decrease the risk of compromising investigations and prevent the duplication of efforts.

609.3 TACTICAL COMMANDER

The Chief of Police will designate a member of this department to be the tactical commander.

The tactical commander will develop and maintain a risk assessment form (the risk assessment matrix) for use in assessing, planning and coordinating high-risk operations. The matrix also should provide a process for supervisors to identify operations that have a lower level of risk.

The tactical commander will review risk assessments with operations supervisors to determine whether a particular incident qualifies as high-risk.

609.3.1 REPORTING REQUIREMENTS

The tactical commander or designee shall ensure that reports of all warrants served by SWAT in the prior year are submitted to the Records Unit by February 1 of each year via the RMS Law Enforcement Transparency Template and/or an After Action Report. Supervisors of officers serving a warrant where forcible entry was used, but SWAT was not utilized, shall be responsible for ensuring reporting compliance with the state requirements by submitting the RMS Law Enforcement Transparency Template for each such instance.

Salt Lake City Police Department

SLCPD Policy Manual

SLCPD Policy Manual

Operations Planning and Deconfliction

The Records Unit shall compile the information and forward a final report in the format developed by the Commission on Criminal and Juvenile Justice (CCJJ), as required by Utah Code 77-7-8.5, to the Chief of Police.

The Chief of Police shall review and approve the report and ensure that it is forwarded to the CCJJ and the designated recipient for the City no later than April 30.

609.4 RISK ASSESSMENT

609.4.1 RISK ASSESSMENT FORM PREPARATION

Officers assigned as operational leads for any operation that qualifies, or may qualify as a high-risk operation, such as search warrant service, shall complete a risk assessment matrix.

If the operation is the service of a search warrant and the location to be searched is currently secured by officers, completing the risk assessment matrix is not necessary. An unsecured location is defined as any building or area to be searched that may have unsecured person(s) within. When completing a risk assessment matrix, proper procedure shall be followed. [Salt Lake City Police Department Procedure Manual: 604.2 RISK ASSESSMENT MATRIX](#)

When preparing the form, the officer should check all relevant and reasonable intelligence resources, criminal justice databases, target deconfliction systems, and resources for information about the target person and any others who may be present.

Depending on the circumstances and resources, the officer should also gather available information that includes, but is not limited to:

- (a) Photographs, including aerial photographs, if available, of the target location, neighboring yards and obstacles.
- (b) Geographical maps of the target location.
- (c) Diagrams of any property and the interiors of buildings that are involved.
- (d) The target person (e.g., history of weapon possession or use, known mental illness, known drug use, threats against police, gang affiliation, criminal history).
- (e) Others who may be present at the target location (e.g., other criminals, innocent third parties, children, animals). Obstacles associated with the target location (e.g., fortification, booby traps, reinforced doors or windows, surveillance cameras, lookouts, the number and type of buildings, geographic and physical barriers, the number and type of weapons likely to be present, information that suggests the presence of explosives, chemicals or other hazardous materials, the potential for multiple dwellings or living spaces, availability of keys or door combinations).
- (f) Other environmental factors (e.g., nearby venues, such as schools and day care centers, proximity of adjacent homes or other occupied buildings, anticipated pedestrian and vehicle traffic at the time of service).
- (g) Other available options that may minimize the risk to officers and others (e.g., making an off-site arrest or detention of the target person).

Salt Lake City Police Department

SLCPD Policy Manual

SLCPD Policy Manual

Operations Planning and Deconfliction

609.4.2 RISK ASSESSMENT REVIEW

Officers will present the risk assessment form and other relevant documents, such as copies of search warrants, affidavits and arrest warrants, to their supervisors and to the tactical commander.

The supervisor and the tactical commander shall confer to determine, based on the assessment, the operation's level of risk. SWAT shall serve all search warrants on unsecured targets, regardless of risk assessment matrix score. The overall matrix score will serve as a guide to determine how SWAT will serve the warrant.

609.4.3 HIGH-RISK OPERATIONS

High-risk operations involve circumstances that present higher risks than are commonly faced by officers on a daily basis and would require the steps to mitigate risk detailed in this policy.

If the operation is designated as a high-risk operation, the tactical commander should proceed as follows:

- (a) Determine what resources will be needed at the location or placed on standby, such as:
 1. SWAT
 2. Extra personnel
 3. Outside agency assistance
 4. Special equipment
 5. Medical personnel
 6. Persons trained in negotiation
 7. Additional surveillance or information
 8. Canines
- (b) Contact the appropriate department members, or other agencies as warranted, to begin preparation.
- (c) Direct, or delegate the direction of, the actual operation.
- (d) Ensure that all legal documents, such as search warrants, are complete, with any modifications that may be necessary to support the operation.

609.5 DECONFLICTION

The officer who is the operation lead shall ensure the investigative target and location have been entered in the regional target deconfliction system (RISSNET) to determine if there is conflicting activity by other agencies involving the same individual, group, or location. All deconfliction for this department is done through RISSNET. Deconfliction should occur as early in the process as practicable. The officer should also enter updated information when it is received. If any conflict is discovered, the supervisor will contact the involved jurisdiction and resolve the potential conflict before proceeding with the operation.

Officers have three department resources to assist in deconflicting an operation:

Salt Lake City Police Department

SLCPD Policy Manual

SLCPD Policy Manual

Operations Planning and Deconfliction

1. During regular working hours, officers can contact the SLIC.
2. During times outside regular working hours, officers can contact a Records Unit supervisor.
3. If an employee has access to RISSNET, they may conduct the deconfliction.

609.6 OPERATION PLAN

The tactical commander should ensure that a written plan is developed. The plan should address such issues as:

- (a) Operation goals, objectives and strategies.
- (b) Information from the risk assessment form, by attaching a completed copy in the operation plan.
 1. The volume or complexity of the information may indicate that the plan includes a synopsis of the information contained on the risk assessment form to ensure clarity and highlighting of critical information.
- (c) Participants and their roles:
 1. An adequate number of uniformed officers are included in the operation team to ensure the operation is recognized as a legitimate law enforcement operation.
 2. How all participants will be identified as law enforcement.
- (d) Whether deconfliction submissions are current and that all target individuals, groups and locations have been deconflicted to the extent reasonably practicable.
- (e) Identification of communications channels and call-signs.
- (f) Use of force issues.
- (g) Contingencies for handling medical emergencies (e.g., services available at the location, closest hospital, closest trauma center).
- (h) Plans for detaining people who are not under arrest.
- (i) Contingencies for handling children, dependent adults, animals and other people who might be at the location.
- (j) Documentation of actions and responsibilities for collection, review and approval of reports.

609.6.1 OPERATION PLAN RETENTION

Since the operation plan contains intelligence information and descriptions of police tactics, it shall not be filed with the police report package. It shall be stored separately and retained in accordance with the established records retention schedule.

609.7 OPERATION BRIEFING

A briefing should be held prior to the commencement of the operation to allow all participants to understand the operation, see and identify each other, identify roles and responsibilities, and to

Salt Lake City Police Department

SLCPD Policy Manual

SLCPD Policy Manual

Operations Planning and Deconfliction

ask questions or seek clarification as needed. Anyone who is not present at the briefing should not be present at the location of the operation without specific supervisory approval.

- (a) The briefing should include a verbal review of the plan's elements, using visual aids, to enhance the participants' understanding of the plan.
- (b) All participants should be provided a copy of the plan and search warrant, if applicable. If a search warrant is being served, participating personnel should be directed to read the search warrant and initial a copy that is retained with the operation plan. Any items to be seized should be identified at the briefing.
- (c) The operations tactical commander or supervisor at the briefing shall ensure that all participants are visually identifiable as law enforcement officers.
 - i. Exceptions may be specifically identified because of a specialized function, such as officers who are conducting surveillance or working undercover. However, those members exempted from visual identification should be able to transition to a visible law enforcement indicator at the time of enforcement actions, such as entries or arrests.
- (d) The briefing should include details of the communications plan.
 - (a) It is the responsibility of the operation supervisor to ensure that Dispatch is notified of the time and location of the operation.
 - (b) If the radio channel needs to be monitored by Dispatch, the dispatcher assigned to monitor the operation should attend the briefing and receive a copy of the operation plan, if practical.
 - (c) The briefing should include a communications check to ensure that all participants are able to communicate with the available equipment on the designated radio channel.
 1. The tactical commander may decide to forego this if they believe it to be detrimental to the operation.

609.8 SWAT PARTICIPATION

The SWAT supervisor shall assume operational control until the individuals at the scene are appropriately detained and it is safe to begin a search. When this occurs, the SWAT supervisor shall transfer control of the scene to the handling supervisor. This transfer should be communicated to the officers present.

609.9 MEDIA ACCESS

No advance information regarding the operation shall be released without the approval of the Chief of Police. Any media inquiries or press release after the fact shall be handled in accordance with the Media Relations Policy.

609.10 DEBRIEFING

As soon as reasonably practicable, the operation should be debriefed. The debriefing should include as many participants as possible.

Salt Lake City Police Department

SLCPD Policy Manual

SLCPD Policy Manual

Operations Planning and Deconfliction

609.11 REVISIONS

Enacted: April 9, 2018

Unmanned Aircraft System (UAS) Operations

610.1 PURPOSE AND SCOPE

The purpose of this policy is to establish guidelines for the use of an unmanned aircraft system (UAS) and for the storage, retrieval and dissemination of images and data captured by the UAS.

610.1.1 DEFINITIONS

Definitions related to this policy include:

Certificate of Authorization (COA) - An authorization issued by the Federal Aviation Administration to a public operator granting approval for specific flight operations.

Digital Multimedia Evidence (DME) - Digital recording of images, sounds, and associated data.

Program Manager (PM) - The individual responsible for the administrative functions related to the UAS program.

Remote Pilot in Command (RPIC) - The individual exercising control over the UAS during flight, and who is responsible for the overall flight operations for a specific mission.

Target - A person upon whom, or an object, structure, or area upon which, another person has intentionally collected or attempted to collect information through the operation of an unmanned aircraft system, or intends to collect or to attempt to collect information through the operation of an unmanned aircraft system (Utah Code 72-14-202(4)).

Unmanned Aircraft System (UAS) – An unmanned aircraft of any type that is capable of sustaining flight whether preprogrammed or remotely controlled (commonly referred to as an unmanned aircraft) and all of the supporting or attached systems designed for gathering information through imaging, recording or any other means (Utah Code 72-14-102).

Visual Line-of-Sight (VLOS) - A method of control and collision avoidance that refers to the Remote Pilot in Command or Visual Observer directly viewing the UAS with human eyesight.

Visual Observer (VO) - A trained person who assists the Remote Pilot in Command in the duties associated with collision avoidance. This includes, but is not limited to, avoidance of other traffic, clouds, obstructions, and terrain.

610.2 POLICY

A UAS may be utilized to enhance the department's mission of protecting lives and property when other means and resources are not available or are less effective. Any use of a UAS will be in strict accordance with constitutional and privacy rights and Federal Aviation Administration (FAA) regulations.

610.2.1 PROHIBITED USE

A UAS shall not be used:

- To conduct random surveillance activities.

Salt Lake City Police Department

SLCPD Policy Manual

SLCPD Policy Manual

Unmanned Aircraft System (UAS) Operations

- To conduct random patrolling activities.
- To target a person based solely on individual characteristics, such as but not limited to, race, ethnicity, national origin, religion, disability, gender, or sexual orientation.
- To harass, intimidate, or discriminate against any individual or group.
- To facilitate revenue-generating activities, such as monitoring parking areas.
- To conduct personal business of any type.

The UAS shall not be weaponized (Utah Code 72-14-303).

610.3 PRIVACY

The use of a UAS potentially involves privacy considerations. To ensure individuals' privacy rights are not infringed upon, RPICs shall only operate a UAS to obtain and/or use DME in the following circumstances (Utah Code 72-14-203):

- (a) Pursuant to a search warrant.
- (b) In accordance with judicially recognized exceptions to warrant requirements (e.g., operation over areas where no reasonable expectation of privacy exists, exigent circumstances, consent from an individual who has apparent authority to consent, etc.).
- (c) To locate a lost or missing person in an area in which a person has no reasonable expectation of privacy.
- (d) For training purposes (no training may occur over areas where people have a reasonable expectation of privacy).

If a UAS mission is conducted pursuant to a judicially recognized warrant exception, the exception(s) shall be documented fully and completely by the RPIC in a resulting report.

If a UAS mission is conducted pursuant to consent from an individual who has apparent authority to consent, the consent must be in writing and must specify the period for which the operation of the UAS is authorized.

RPICs shall take reasonable precautions to avoid inadvertently recording or transmitting images of areas where there is a reasonable expectation of privacy that is not the focus of an approved investigation or operation. Reasonable precautions can include, for example, deactivating or turning imaging devices away from such areas or persons during UAS operations.

610.4 PROGRAM MANAGER

The Chief of Police will appoint a Program Manager (PM) who will be responsible for the management of the UAS program. The PM will ensure that policies and procedures conform to current laws, regulations, and best practices, and will have the following additional responsibilities:

- Coordinating the FAA Certificate of Waiver or Authorization (COA) application process and ensuring that the COA is current.

Salt Lake City Police Department

SLCPD Policy Manual

SLCPD Policy Manual

Unmanned Aircraft System (UAS) Operations

- Ensuring that all authorized RPICs, and observers have completed all required FAA and department-approved training in the operation, applicable laws, policies, and procedures regarding the use of the UAS.
- Developing a uniform protocol for submission and evaluation of requests to deploy a UAS, including urgent requests made during ongoing or emerging incidents.
- Implementing a system for public notification of UAS deployment.
- Developing operational protocol governing the deployment and operation of a UAS including, but not limited to, safety oversight, use of Visual Observers, establishment of lost link procedures, and secure communication with air traffic control facilities.
- Developing a protocol for fully documenting all missions (Utah Code 72-14-205).
- Developing UAS inspection, maintenance, and record-keeping protocol to ensure the continuing airworthiness of a UAS, up to and including its overhaul or life limits.
- Developing protocols to ensure that all video and data intended to be used as evidence are accessed, maintained, stored, and retrieved in adherence to the chain of custody requirements.
- Facilitating law enforcement access to images and data captured by its UAS.
- Developing protocols that ensure retention and purge periods are maintained in accordance with established records retention schedules.
- Recommending program enhancements, particularly regarding safety and information security.
- Ensuring that established protocols are followed by monitoring and providing periodic reports on the program to the Chief of Police.
- Ensuring that data collected on a person, object, structure, or area that is not a target, as defined by Utah Code 72-14-202, is not used, copied, or disclosed (Utah Code 72-14-204).

610.5 OPERATION OF UAS

Only SLCPD FAA-certified RPICs may operate a department UAS. The department has adopted the use of UASs to provide an aerial visual perspective in responding to emergency situations and exigent circumstances, and for the following objectives:

- (a) **Situational awareness:** To assist decision-makers (e.g. incident command staff, first responders, city, county, and state officials) in understanding the nature, scale, and scope of an incident, in planning and coordinating an effective response.
- (b) **Search and rescue:** To assist missing person investigations, AMBER Alerts, and other search and rescue missions.
- (c) **Tactical deployment:** To support the tactical deployment of officers and equipment in emergency situations like incidents involving hostages, barricades, support for large-scale tactical operations, and other temporary perimeter security situations.

Salt Lake City Police Department

SLCPD Policy Manual

SLCPD Policy Manual

Unmanned Aircraft System (UAS) Operations

- (d) Visual perspective: To provide an aerial visual perspective to assist officers in providing direction for crowd control, traffic incident management, special circumstances, and temporary perimeter security.
- (e) Scene documentation: To document a crime scene, accident scene, or other major incident scenes like disaster management, incident response, or large-scale forensic scene investigation.

610.5.1 TEMPORARY FLIGHT RESTRICTION DUE TO WILDLAND FIRES

A department UAS shall not be used in an area under a temporary flight restriction as a result of a wildland fire without the permission of, and in accordance with the restrictions established by, the official in command of the fire response (Utah Code 65A-3-2.5).

610.5.2 MAINTENANCE

The department and PM shall make available to the FAA, upon request, any department-owned or maintained UAS for inspection or testing, and any associated documents/records the FAA requires the department to keep. Each aircraft will have the required FAA Aircraft markings issued by the FAA. If the aircraft is too small to display markings in standard size, the aircraft will display markings in the largest practical manner.

The maintenance of UASs will be the responsibility of the PM in accordance with the manufacturer recommendations. If non-routine maintenance is performed, a test flight shall be conducted and documented to ensure the UAS is operating properly. All maintenance performed on the aircraft will be documented on a maintenance log for that aircraft and be readily available for inspection if requested.

The storage of all department-owned UASs shall be in accordance with manufacturer recommendations, and within a secured department facility or vehicle.

610.6 DOCUMENTATION

The following information must be documented in any related report or other records of the law enforcement encounter when the UAS is operated by a member of the Salt Lake City Police Department, or when the Department obtains or receives data pursuant to Utah Code 72-14-203 (Utah Code 72-14-205):

- (a) The presence and use of the UAS
- (b) Any data acquired
- (c) If applicable, the private citizen from whom the data was received

610.11 RETENTION OF UAS DATA

The SO is responsible for correctly labeling, categorizing, and uploading collected data from a UAS operation to the department's evidence.com account. This shall occur as soon as practical after the conclusion of a flight. Upon verifying that the data was successfully uploaded, the SO shall destroy all other copies of the data.

Salt Lake City Police Department

SLCPD Policy Manual

SLCPD Policy Manual

Unmanned Aircraft System (UAS) Operations

The SO shall mark any data that is determined to fall within the following categories as "evidence", and the data shall be retained until adjudication of final disposition (Utah Code 72-14-204):

- (a) Data that relates to the target of an operation or investigation, and that data is requisite for the success of the operation or investigation.
- (b) Data that was collected inadvertently, and the data appears to pertain to the commission of a crime.
- (c) The data pertains to an emergency situation, and using the data would assist in remedying the emergency.
- (d) The data is received through a court order that requires a person to release the data to the Department or prohibits the destruction of the data.

The SO shall mark any data that is determined to not fall within one of the above listed categories as "UAS non-evidence data". UAS non-evidence data shall be retained for 30 days, after which it will be deleted.

610.11.1 DATA COLLECTED BY PRIVATE CITIZEN

The Salt Lake City Police Department may not accept or review data captured by a privately owned UAS unless one of the following conditions exists (Utah Code 72-14-203):

- (a) The person delivering the UAS data informs the Department that the data appear to pertain to the commission of a crime.
- (b) The receiving member, in good faith, believes that the data pertain to an imminent or ongoing emergency that involves the danger of death or serious bodily injury to another person and that the disclosure of the data will permit the Department to assist in responding to the emergency.

610.11.2 DATA AUDITS

The Audit and Inspections Unit will audit the data collected by the UAS and ensure that it is compliant with applicable policies, procedures, laws, and retention schedules.

610.8 REVISIONS

Enacted: May 23, 2022

Undercover Operations

611.1 PURPOSE AND SCOPE

Undercover operations take place in an ever-evolving environment and present an elevated level of risk for all involved. This policy provides members who participate in undercover operations with necessary guidelines to ensure such operations are conducted in a safe manner.

611.1.1 DEFINITIONS

Undercover Operation – An authorized clandestine criminal investigation involving the use of sworn officers, confidential informants, or other cooperating individuals, in an attempt to actively infiltrate or otherwise covertly gather information or evidence from an individual or group reasonably suspected of being involved in criminal activity. Examples include but are not limited to: purchases of contraband and evidence, “buy-bust” operations, reverse stings, controlled buys, murder for-hire, and conspiracy investigations.

611.2 POLICY

Dynamic situations may arise where sworn members of the department may need to utilize an undercover operation in the course of their duties. Any officer who intends to engage in an undercover operation must first inform his/her supervisor. No undercover operation will take place without approval from a supervisor. The approving supervisor shall assist the investigating officer(s) in determining the type of undercover operation needed, the planning of the operation, and the execution of the operation.

While this policy provides general guidelines for undercover operations, it does not cover all aspects of an undercover operation or assignment. Officers and supervisors should refer to the department's Undercover Operations Training Manual for additional information.

611.3 UNDERCOVER PERSONNEL REQUIREMENTS

No Salt Lake City Police Department officer will operate in an undercover role until the officer has demonstrated an understanding of the department's Undercover Operations Training Manual and has successfully completed the Salt Lake City Police Department Undercover Academy.

611.4 SUPERVISOR RESPONSIBILITIES

The managing supervisor has the following responsibilities in an undercover operation:

- (a) Determine if the undercover aspect of the operation could best be handled in cooperation with the Unit that normally investigates such cases (i.e., narcotics, gangs, and/or vice detectives). These Units can assist in handling undercover and close-cover roles, as well as provide specialized electronic monitoring equipment.
- (b) Ensure that all officers who are tasked to work in an undercover capacity have been properly trained for that role.
- (c) Ensure that a proper operation plan is completed and reviewed before the execution of any undercover operation (refer to the Operations Planning and Deconfliction Policy for operation plan guidelines).

Salt Lake City Police Department

SLCPD Policy Manual

SLCPD Policy Manual

Undercover Operations

- (d) Ensure that proper transmitting and receiving equipment needed to monitor the undercover operation is in place prior the commencement of the operation. No undercover operation utilizing a department member in an undercover role will take place without proper equipment to ensure the undercover member's safety.
- (e) Ensure that arrest or take-down teams are readily identifiable as police officers. Uniformed officers should be used as arrest team members to avoid any argument that the suspect could not identify the arrest teams as police officers.
- (f) Ensure that the investigative target and/or location of the undercover operation have been entered in the regional target deconfliction system (RISSNET) to determine if there is conflicting activity by other agencies involving the same individual, group, or location.

611.4.1 DECONFLICTION

All deconfliction for this department is completed through RISSNET. Deconfliction should occur as early in the operation planning as practicable. If any conflict is discovered, the supervisor will contact the involved jurisdiction and resolve the potential conflict before proceeding with the operation.

Officers have three department resources to assist in deconflicting an operation:

1. During regular working hours, officers can contact the SLIC.
2. During times outside regular working hours, officers can contact a Records Unit supervisor.
3. If an employee has access to RISSNET, they may conduct the deconfliction.

611.5 REVISIONS

Enacted: April 9, 2018

Investigative Use of Social Media and Internet Sources

612.1 PURPOSE AND SCOPE

This policy provides proper guidelines for members utilizing Social Media and Internet sources for investigative purposes.

612.2 POLICY

Use of social media and any other Internet source to access information for the purpose of criminal investigation shall comply with applicable laws and policies regarding privacy, civil rights, and civil liberties. Information gathered via the Internet should only be accessed by members while on-duty and for purposes related to the mission of this department.

612.3 OFF-DUTY DISCOVERIES

If a member encounters information relevant to a criminal investigation while off-duty or while using his/her own equipment, the member should note the dates, times, and locations of the information and report the discovery to his/her supervisor as soon as practicable. The member, or others who have been assigned to do so, should attempt to replicate the finding when on-duty and using department equipment.

612.4 RECORD KEEPING

Information obtained via the Internet should not be archived or stored in any manner other than department-established record keeping systems (see the Records Maintenance and Release and Criminal Organizations policies).

612.5 INVESTIGATIVE USES

During the course of an investigation, a member may locate the social media profile of a victim, witness, or suspect. If the member has been unable to identify another means to contact the individual, or if contact via social media is preferable, the member may elect to contact the individual using their social media profile. Members may use a true name or alias social media profile to make contact. If contact is established:

- (a) A member will immediately identify themselves and provide contact information.
- (b) Members must consider whether contacting the subject in this manner will reveal an individual's cooperation with law enforcement and whether that will pose an undue risk to that individual's personal safety.
- (c) Members must consider the implications of this type of contact for the case being investigated.
- (d) Members shall not use personal accounts to make such contacts.

612.5.1 COVERT USE OF SOCIAL MEDIA

An online alias may only be used to seek or retain information that:

Salt Lake City Police Department

SLCPD Policy Manual

SLCPD Policy Manual

Investigative Use of Social Media and Internet Sources

- (a) Is based upon a criminal predicate or threat to public safety; or
- (b) Is based upon reasonable suspicion that an identifiable individual, or organization has committed a criminal offense or is involved in or is planning criminal conduct or activity that presents a threat to any individual, the community, or the nation and the information is relevant to the criminal conduct or activity; or
- (c) Is relevant to the investigation and prosecution of suspected criminal incidents or the prevention of crime; or
- (d) Is useful in crime analysis or situational assessment reports for the administration of criminal justice and public safety.

612.5.2 AUTHORIZATION FOR ONLINE ALIASES AND ONLINE UNDERCOVER ACTIVITY

Members must submit a request for an online alias or multiple aliases to their immediate supervisor. This request may be made via email.

Online undercover activity occurs when the member utilizing the online alias interacts with a person via social media. Online undercover operations will only be utilized when there is a reason to believe that criminal offenses have been, will be, or are being committed. Members should utilize the appropriate deconfliction system when using online aliases in an investigation that normally would require deconfliction.

612.6 REVISIONS

Enacted: April 9, 2018

Revised: December 5, 2018

Truth Verification Instruments

613.1 PURPOSE AND SCOPE

This policy outlines guidelines for the administration of Truth Verification Instruments (TVIs) by the Salt Lake City Police Department. This policy is applicable to all agency members who may be subject to examination by a TVI, or utilizing a TVI as an investigative tool.

613.1.1 DEFINITIONS

Truth Verification Instrument (TVI) - An instrument (e.g., computer voice stress analyzer, polygraph, etc.) that assists investigators in determining the veracity of subjects' statements, including suspects, persons of interest, charged or accused persons, complainants, victims, and witnesses. Although TVI results are not intended for court purposes, they do assist in providing focus to investigations.

Computer Voice Stress Analyzer (CVSA) - A psycho-physiological stress evaluator that detects, measures, and charts the stress in a person's voice by live or tape analysis following a series of pre-formatted questions.

Converus EyeDetect Test - A TVI that measures subtle changes in the eye to detect deception.

Polygraph - A multi-channel instrument that measures physiological reaction to stress by measuring respiration, pulse, galvanic skin results, etc.

Qualified Examiner - A member of the Department who has been trained and certified by an institution qualified to provide training for TVIs.

Overt Interviews - Live - In-person interviews conducted by a qualified examiner with an examinee. These interviews are conducted with the examinee's prior knowledge and consent. An overt interview shall cease immediately if requested by the examinee.

Overt Interviews - Audio - An analysis of an audio recorded interview by a CVSA examiner. The audio recording is made with the examinee's prior knowledge and consent. The interviews are designed to capture a "Yes" or "No" response to pre-formatted questions. The CVSA examiner analyzes the recorded interview using the CVSA instrument.

Covert Examination - A covert examination may be made via an audio recorded or telephone interview with an individual who has no immediate knowledge that they have been asked questions that will be analyzed utilizing a CVSA. All covert examinations must have the approval of the Division Commander, or designee, over the Division the related investigation is being conducted in. The TVI Supervisor shall also be advised of all covert examinations. All covert examinations shall comply with clearly established rights under the United States and Utah Constitution.

Cold-Call - An examination of TVI charts by another qualified TVI examiner who is not associated or familiar with an initial TVI examination. A cold-call examiner is requested to evaluate the results of an examination based strictly on the assessment of the charts that were generated from the initial examination.

Salt Lake City Police Department

SLCPD Policy Manual

SLCPD Policy Manual

Truth Verification Instruments

Employee Polygraph Protection Act (EPPA) - The law that regulates polygraph examinations of employees in civilian professions for private companies. Both polygraphs and CVSA examinations are regulated by the EPPA. Employees working for federal, state, or municipal agencies are not protected by this act as these employers are exempt from the provisions within.

613.2 POLICY

The primary TVI employed by the Salt Lake City Police Department is the CVSA. A polygraph or Converus EyeDetect Test may be employed if circumstances dictate.

Examinations shall only be conducted and interpreted by trained, qualified examiners. Examinations may be used in an investigation being conducted by the Salt Lake City Police Department, or in response to a request from another public safety agency.

Federal and State laws pertaining to polygraph examinations will apply to the use of the CVSA unless changes or additions to applicable laws are made specifically addressing CVSA examinations.

A TVI examination shall not be used as a substitute for good investigative processes.

Examination results shall not serve as a final determinate. Rather, examination results should be used to develop leads and verify, corroborate, or refute statements; or refute an allegation that cannot be verified or disproved by other investigative means.

Overt interviews (live and audio) and covert examinations may be conducted with witnesses, suspects, complainants, and victims. Victims of sexual offenses shall not be asked to submit to a truth verification exam as a condition of continuing the investigation.

Department members may not be compelled to submit to an examination and shall not be subject to a covert examination.

Examinations shall be audio recorded at a minimum. A video recording, if practical and possible, is preferred.

613.3 EXAMINER RESPONSIBILITIES

Qualified examiners shall keep all required certifications current for the operation of TVIs they utilize. Qualified examiners shall also maintain proficiency in examination and the proper use of applicable equipment.

Truth verification examiners shall keep their direct supervisor informed of all scheduled examinations.

Prior to beginning an examination, all examinees in criminal cases shall be advised of their *Miranda* rights by the examiner if their *Miranda* rights were not previously waived during the course of the investigation, and if required by law.

All examinees shall be asked to verbally acknowledge that they wish to take the exam, with the exception of covert examinations.

Salt Lake City Police Department

SLCPD Policy Manual

SLCPD Policy Manual

Truth Verification Instruments

Prior to administering an examination, a qualified examiner shall review the available information pertaining to the investigation and prepare all questions to be used in the examination. To prepare the examinee for the examination (except in covert examinations), the qualified examiner shall explain the examination procedures to the examinee and review each test question with the examinee prior to the examination.

A CVSA examiner is responsible for determining if there is any possibility that exam results of a CVSA examination may become contaminated by factors such as ambient noise.

No individual, other than the examinee and certified examiner(s), will be present inside an examination room during the course of an examination. Exceptions to this rule include if an interpreter is required, or if the examination is taking place in a medical facility where medical personnel are required to be present to administer or monitor an examinee's medical condition or needs.

The qualified examiner shall independently interpret the charts generated during the administration of an examination and render an opinion of finding to include:

- (a) Deception Indicated (DI);
- (b) No Deception Indicated (NDI); or
- (c) The need for an additional chart or examination.

All TVI examination results may be subject to a cold-call by another qualified examiner to help ensure accuracy and to mitigate the possibility of examiner bias. Cold-calls should be sought as soon as reasonably possible after an initial exam.

Results of a TVI examination shall be documented in a report that includes a conclusion section indicating the examiner's opinion of finding and any statements that may need follow-up by the case investigator. The results of each individual examination shall also be recorded in the examination log of the respective examiner, which all qualified examiners shall individually maintain. The log shall include the date of the exam, the case number (if applicable), the subject being examined, the officer requesting the exam, whether deception was indicated or not, the examiner who cold-called the exam and their conclusion, and the TVI used.

All charts, examination reports, consent forms, audio or videotapes, etc. shall be treated as confidential by qualified examiners. Such material shall be provided to the officer/detective who requested the examination.

613.4 REQUESTING PERSONNEL RESPONSIBILITIES

Non-urgent requests for an examination should be made directly to a qualified TVI examiner by the requesting officer/detective. An email requesting the examination should be sent to the examiner and the TVI supervisor. If the requesting personnel needs assistance in locating an examiner, the TVI supervisor should be consulted. Careful consideration should be made before requesting a truth verification examination, and all other investigative leads should be thoroughly attempted prior to requesting an examination.

Salt Lake City Police Department

SLCPD Policy Manual

SLCPD Policy Manual

Truth Verification Instruments

Requesting personnel are responsible for providing the assigned examiner all pertinent information concerning the case as deemed necessary by the examiner. This includes, but is not limited to:

- (a) Information that supports the use of an examination.
- (b) Background information on the subject to be examined.
- (c) Any statements made by the subject, complainant, or witnesses to include alibis.

Requesting personnel are responsible for notifying the examinee of the time and location of the exam, and providing transportation if necessary. Requesting personnel shall also notify the examiner immediately if the subject cancels an examination appointment.

Requesting personnel, or any other member of the Salt Lake City Police Department, shall not attempt to explain TVI procedures to an examinee, but shall advise the examinee that the procedures will be explained by the qualified examiner. Requesting personnel shall advise overt examinees that the examination is voluntary.

Requesting personnel shall make themselves available to the examiner throughout the entire course of the examination, unless deemed unnecessary by the examiner. Requesting personnel may arrange for a designee to attend the examination, only when and if the personnel replacing them is knowledgeable in all aspects of the case.

Results of the examination will be made available to the requesting personnel who are then responsible for conducting appropriate follow-up investigation.

No member of the Salt Lake City Police Department involved in an investigation where a TVI has been utilized will discuss the results of a truth verification examination, or in any manner convey information concerning the results of that examination, with the examinee's civilian employer (EPPA Sec. 801.4(c)), unless that civilian employer is exempt from the disclosure provision.

Any law enforcement report generated as a result of a criminal investigation during which a TVI examination was conducted may indicate that the examination was administered, but may not include the results of that examination (with the exception of the examiner's report).

613.4.1 UNIQUE CIRCUMSTANCES

Requests for TVI examinations from other agencies conducting criminal investigations may be authorized by a Lieutenant or above. The TVI supervisor shall be notified of such requests.

A call-out of a TVI examiner may be authorized by a Lieutenant or above, or the TVI supervisor.

613.5 TVI EXAM RESTRICTIONS

Examiners shall not conduct an examination on a subject who is not suitable for testing. Individuals who will not be examined include:

- (a) Subjects under 14 years-of-age unless parental or legal guardian consent has been obtained prior to testing. The consent must be in writing and in the possession of the TVI examiner prior to the examination. Subjects under 14 years-of-age must also be able to discern the truth from falsehoods.

Salt Lake City Police Department

SLCPD Policy Manual

SLCPD Policy Manual

Truth Verification Instruments

- (b) Any person who has been forced or coerced into submitting to an examination.
- (c) Any person who has been indicted by a Grand Jury or formally charged with a crime for which the exam is being requested, unless there is an agreement and stipulation signed by the examinee, their attorney, and the prosecutor. The Division Commander of the Criminal Investigations Division and the Deputy District Attorney handling the prosecution must both approve such an examination.
- (d) Any person who is extremely agitated or angry. These persons shall be given sufficient time to regain their composure.
- (e) Any person who exhibits symptoms of severe intellectual disability, or impairment due to alcohol and/or drugs to a degree that causes the examiner concern.

Examiners shall not conduct an examination that may compromise their integrity (i.e., conducting an examination on an individual with whom the examiner has a close personal relationship). These examination requests must be deferred to a neutral examiner.

Examiners shall not violate standards taught by attended certified examiner courses or any provision of this policy. In the event that an examiner declines to administer an examination and the decision is questioned, a second opinion from another similarly trained and qualified examiner is required before an examination is conducted.

613.6 PRE-EMPLOYMENT TVIS

Qualified examiners shall conduct TVI examinations of applicants seeking employment with the Salt Lake City Police Department when required. Pre-employment TVI examinations will be completed at the direction of the background investigator assigned to the applicant to be tested. The unsuccessful completion of a TVI examination shall not be the sole determining factor for removal of an applicant from the hiring process with the Salt Lake City Police Department. Results of a pre-employment TVI examination shall be treated as confidential and shall only be discussed with other Department members who have a legitimate role in the background investigation process or are tasked with making a hiring decision. Refer to the Recruitment and Selection Policy for further detail.

613.7 TRAINING

Newly certified examiners will be mentored by a more experienced examiner and shall be limited to conducting background TVI examinations for their first 10 exams. It will be the job of the mentor to coach the new examiner on interpreting the charts correctly and advising on interview styles that may assist in eliciting voluntary admissions. If after 10 background exams the new examiner has demonstrated proficiency, they may be authorized to conduct another 10 background TVI examinations without supervision. If after 20 background examinations a new examiner has demonstrated proficiency, they may be authorized to conduct criminal case examinations upon recommendation from their mentor. Mentors shall report their findings and recommendations to the TVI supervisor. The TVI supervisor, with input from the mentor, may determine extended probation is necessary. If warranted, the TVI supervisor may release the new examiner from TVI duties.

Salt Lake City Police Department

SLCPD Policy Manual

SLCPD Policy Manual

Truth Verification Instruments

Annual training should be scheduled by the TVI supervisor. The annual training shall include any relevant recent case law, new trends, or other topics deemed relevant by the TVI supervisor.

Training shall be documented.

613.8 REVISIONS

Enacted: September 25, 2018

Chapter 7 - Equipment

Department-Owned and Personal Property

700.1 PURPOSE AND SCOPE

Department employees are expected to properly care for Department property assigned or entrusted to them. Employees may also suffer occasional loss or damage to personal or Department property while performing their assigned duty. Certain procedures are required depending on the loss and ownership of the item.

700.2 CARE OF DEPARTMENTAL PROPERTY

In general, equipment that is assigned by the Quartermaster, Special Weapons and Tactics team or the Public Order Unit, remain under their respective realms of responsibility to maintain and replace. Employees shall be responsible for the safekeeping, serviceable condition, proper care, use and replacement of Department property assigned or entrusted to them. An employee's intentional or negligent abuse or misuse of Department property may lead to discipline including, but not limited to the cost of repair or replacement and may constitute a felony under Utah Code section 76-8-402 (see Authorized Personal Use of Public Property Policy).

- (a) Employees shall promptly report through their chain of command any loss, damage to or unserviceable condition of any Department-issued property or equipment assigned for their use.
- (b) The use of damaged or unserviceable Department property should be discontinued as soon as practical and replaced with comparable Department property as soon as available and following notice to a supervisor.
- (c) Except when otherwise directed by competent authority or required by exigent circumstances, Department property shall only be used by those to whom it was assigned. Use should be limited to official purposes and in the capacity for which it was designed.
- (d) Department property shall not be thrown away, sold, traded, donated, destroyed or otherwise disposed of without proper authority.
- (e) In the event that any Department property becomes damaged or unserviceable, no employee shall attempt to repair the property without prior approval of a supervisor.

Personnel who have the responsibility of issuing or transferring equipment to members will maintain a record of the equipment that they assign including the name and ID of the employee, a description of the equipment and any model or serial numbers if available. Equipment unaccounted for will become the responsibility of the last member that it was assigned to. The Department, or any component thereof, may perform periodic inspections and audits of equipment issued to members of the Department.

Members will not carry or use unauthorized equipment.

Salt Lake City Police Department

SLCPD Policy Manual

SLCPD Policy Manual

Department-Owned and Personal Property

700.2.1 LOST OR STOLEN DEPARTMENT EQUIPMENT

Whenever an employee loses assigned equipment, a lost property report must be completed when the loss is discovered. Property that has been stolen from the officer or department will be reported as any other crime.

In either case, lost property or stolen City property situations require a memo be sent to the member's Division Commander through the chain of command. An email with the case number will also be forwarded within two weeks by the officer's supervisor to the appropriate supervisor of the department entity which issued the equipment.

700.2.2 TRANSFERS

Certain Department-issued equipment may be specific to a particular assignment. This equipment may be issued by a Division, the Quartermaster, Fleet, the Training Unit, etc. Equipment will not be transferred to personnel assuming a new assignment without proper documentation of the equipment transfer. Employees who change assignment must return equipment specific to that assignment to the Department entity who issued the equipment.

700.2.3 LEAVE FROM DUTY

When an employee is on leave from an assignment, the Department may request that Department-issued equipment be returned. A written receipt of the returned equipment will be provided to the employee. The equipment may be stored by the Quartermaster or reassigned at the Department's discretion. Commanding officers or their designee will arrange for stored equipment to be maintained in a secure location.

700.2.4 SEPARATION FROM EMPLOYMENT

When an employee separates from employment with the Department, the employee must return all requested Department equipment as per the Quartermaster's instructions.

700.3 FILING CLAIMS FOR PERSONAL PROPERTY

Members are advised that the presence of any personal items at work is at the member's own risk and the any personal item lost or damaged at work may not be replaced. If any personal property is damaged in the course of performing one's duties, the member may complete an official police report documenting the damaged property and seek their Division Commander's approval for repair or replacement. Upon review by Staff and a finding that no misconduct or negligence was involved, repair or replacement may be recommended by the Chief of Police or their designee. If approval is granted, then the member may go out and purchase a replacement and submit the receipt to the Police Financial Unit for reimbursement.

The Department will not replace or repair luxurious or overly expensive items (jewelry, exotic equipment) that are not reasonably required as a part of work.

700.3.1 REPORTING REQUIREMENT

A verbal report shall be made to the employee's immediate supervisor as soon as circumstances permit.

Salt Lake City Police Department

SLCPD Policy Manual

SLCPD Policy Manual

Department-Owned and Personal Property

A written report shall be submitted within the time frame directed by the supervisor to whom the verbal report is made.

700.4 LOSS OR DAMAGE OF PROPERTY OF ANOTHER

Officers and other employees intentionally or unintentionally may cause damage to the real or personal property of another while performing their duties. Any employee who damages or causes to be damaged any real or personal property of another while performing any law enforcement functions, regardless of jurisdiction, shall report it as provided below.

- (a) A verbal report shall be made to the employee's immediate supervisor as soon as circumstances permit.
- (b) A written report shall be submitted before the employee goes off-duty or within the time frame directed by the supervisor to whom the verbal report is made.
- (c) Whenever practicable, Crime Lab will be called to photograph/document the damage.

No employee shall imply or state the City or Department will pay or make reimbursement to any individual or group for any damages or expenses incurred by that individual or group as a result of police action. Any individual or group making a claim for damages or expenses incurred by that individual or group as a result of police action is to be referred to the City Attorney's Office at (801) 535-7788.

700.4.1 DAMAGE BY PERSON OF ANOTHER AGENCY

If employees of another jurisdiction cause damage to real or personal property belonging to the City, it shall be the responsibility of the employee present or the employee responsible for the property to make a verbal report to his/her immediate supervisor as soon as circumstances permit. The employee shall submit a written report before going off-duty or as otherwise directed by the supervisor.

These written reports, along with a memorandum from the supervisor, shall promptly be forwarded to the appropriate Division Commander.

700.5 SURPLUS PROPERTY

Divisions or units that become aware of surplus property in their areas should contact the Quartermaster supervisor to arrange for the disposal of the property. It is the responsibility of the Quartermaster supervisor to determine how surplus items will be disposed of.

700.6 UNIQUE EQUIPMENT THAT IS DAMAGED OR MALFUNCTIONING

- (a) **Firearms** - See the Firearms Policy.
- (b) **Body Worn Cameras** - See the Portable Audio/Video Recorders Policy.
- (c) **Identification Cards** - Designated members shall be issued Department identification cards and/or a Department Key Card Credential. The Quartermaster shall issue these cards. Members are accountable for the use and safekeeping of their Department-issued ID cards, and must return them to the Quartermaster upon separation from the department.

Salt Lake City Police Department

SLCPD Policy Manual

SLCPD Policy Manual

Department-Owned and Personal Property

- i. In the event that a member loses his or her ID or key card credential, emergency notification must be made to the Quartermaster as soon as possible for security reasons. If the loss occurs after normal business hours, or on weekends or holidays, members are to call the on-duty Dispatch supervisor. Key cards can be remotely deactivated. As soon as possible thereafter, during normal work hours, members are to respond to the Quartermaster for a replacement card.
- (d) **IMS Requests** - For technical issues surrounding any Department-issued technology (e.g., laptops, phones, etc.), members will follow proper procedure for requesting IMS assistance. [Salt Lake City Police Department Procedure Manual: 700.2 IMS ASSISTANCE REQUEST](#)

700.7 REVISIONS

Enacted: April 23, 2018

Revised: July 26, 2019

Personal Communication Devices

701.1 PURPOSE AND SCOPE

The purpose of this policy is to establish guidelines for the use of mobile telephones and communication devices, whether issued or funded by the Department or personally owned, while on-duty or when used for authorized work-related purposes.

This policy generically refers to all such devices as Personal Communication Devices (PCD) but is intended to include all mobile telephones, personal digital assistants (PDA) and similar wireless two-way communications and/or portable Internet access devices. PCD use includes, but is not limited to, placing and receiving calls, text messaging, blogging and microblogging, e-mailing, using video or camera features, playing games and accessing sites or services on the Internet.

Refer to the associated Personal Communication Devices Procedure for additional information on litigation holds and the sale of cell phones no longer in use by the Department.

701.2 POLICY

The Salt Lake City Police Department allows employees to utilize department-issued or funded PCDs and to possess personally owned PCDs in the workplace, subject to certain limitations.

Employees who have questions regarding the application of this policy or the guidelines contained herein are encouraged to seek clarification from supervisory personnel.

701.3 PRIVACY POLICY

Employees shall have no expectation of privacy with regard to any communication made with or stored in or through PCDs issued by the Department and shall have no expectation of privacy in their location should the device be equipped with location detection capabilities. The use of any department-provided or -funded PCD, computer, Internet service, telephone service or other wireless service while on-duty is without any expectation of privacy that the employee might otherwise have in any communication, including the content of any such communication. Communications or data reception on personal, password-protected, web-based e-mail accounts and any other services are subject to monitoring if department equipment is used.

701.4 DEPARTMENT-ISSUED PCD

Depending on an employee's assignment and the needs of the position, the Department may, at its discretion, issue or fund a PCD. Department-issued or funded PCDs are provided as a convenience to facilitate on-duty performance. Infrequent personal use is permissible if limited in scope and frequency, and in conformance with the other elements of this policy.

PCDs and the associated telephone number shall be subject to inspection or monitoring (including all related records and content) at any time without notice and without cause.

Some employees will be assigned a cellular phone as their primary use phone for police department business. The monthly service agreement for these employees should be appropriate relative to the employee's assignment. The Quartermaster will periodically audit employees'

Salt Lake City Police Department

SLCPD Policy Manual

SLCPD Policy Manual

Personal Communication Devices

Department cellular phone usage and adjust service agreements as necessary. Employees shall reimburse the Department for cellular phone charges in material excess of the monthly service agreement (materiality is defined as the administrative cost of processing and collecting the reimbursement when it does not substantially override the benefit of the reimbursement itself). Bureau Commanders may authorize charges in excess of the monthly service agreement when the employee provides a reasonable explanation for the additional charges. Bureau Commanders may request that the Quartermaster increase the monthly service agreement for an employee based upon increased cellular phone usage.

Any member who has a Department-issued or funded cellular phone shall set up and keep a functioning voicemail system for it. Unless otherwise specified, members are not obligated or required to carry, access, monitor or respond to electronic communications using a Department-issued or funded PCD while off-duty.

701.5 PERSONALLY OWNED PCD

Employees may carry a personally owned PCD while on-duty, subject to the following conditions and limitations:

- (a) The Department accepts no responsibility for loss of, or damage to, a personally owned PCD.
- (b) The PCD and any associated services shall be purchased, used, and maintained solely at the employee's expense.
- (c) The device shall not be utilized to record any business-related information, including photographs, video, or the recording of any information or material obtained or made accessible as a result of employment with the Department, without the express authorization of the Chief of Police or the authorized designee.

Employees are not obligated or required to carry, access, monitor or respond to electronic communications using a personally owned PCD while off-duty.

701.6 USE WHILE DRIVING

Officers operating emergency vehicles should limit the use of PCDs to matters of official business unless the device is specifically designed and configured to allow hands-free use (Utah Code 41-6a-1716).

Except in an emergency, employees who are operating non-emergency vehicles shall not use a PCD while driving unless the device is specifically designed and configured to allow hands-free use (Utah Code 41-6a-1716).

701.7 SENSITIVE INFORMATION

Employees are reminded that PCDs are not secure devices and conversations may be intercepted or overheard. Caution should be exercised while utilizing PCDs to ensure that sensitive information is not inadvertently transmitted.

Salt Lake City Police Department

SLCPD Policy Manual

SLCPD Policy Manual

Personal Communication Devices

701.8 REVISIONS

Enacted: April 23, 2018

Vehicle Maintenance

702.1 PURPOSE AND SCOPE

Employees are responsible for assisting in maintaining Department vehicles so that they are properly equipped, properly maintained, properly refueled and present a clean appearance.

702.2 VEHICLE REPAIRS AND MAINTENANCE

When a Department vehicle becomes inoperative or is in need of repairs that affect the safety of the vehicle, that vehicle shall be removed from service for repair. Proper notification to Fleet personnel shall be promptly made by the vehicle operator who first becomes aware of the defective condition, describing the correction needed. Proper procedure for obtaining repairs shall be followed. [Salt Lake City Police Department Procedure Manual: 702.2 VEHICLE REPAIRS PROCEDURE](#)

Members shall follow proper procedure for scheduled vehicle maintenance. [Salt Lake City Police Department Procedure Manual: 702.3 SCHEDULED VEHICLE MAINTENANCE](#)

Members are responsible for the general maintenance and proper care of their vehicles. Failure to adhere to these requirements may result in discipline and loss of vehicle assignment. Members will:

- (a) Make daily inspections (when on-duty) of their assigned vehicles for service/maintenance requirements and damage.
- (b) Only use fuel, lubricants, or additives that are provided by the City or approved by the Department.
- (c) Only use the City's Fleet Shops or other facilities authorized by the Department for repairs.
- (d) Maintain an inflated spare tire and necessary tire changing tools in their vehicle. Members are responsible to change any flat tires on their assigned vehicle.
- (e) Obtain approval through their chain of command before installing any add-on equipment that is not initially installed on any City vehicle or making any other vehicle modifications. This includes but is not limited to additional lighting, scanners, electronics, gun locks, or other hardware.
 - i. Any such equipment must be purchased, installed, and maintained at the employee's personal expense. The employee must retain all equipment originally installed on the vehicle.

702.2.1 VEHICLE WINDOW TINT

Sworn personnel may have window tint installed on their Department vehicle with the following conditions:

- (a) The window tint is installed to industry standards by a licensed business that regularly performs tinting services.
- (b) Windshield tint is not allowed.
- (c) The front side windows do not allow less than 43% light transmittance.

Salt Lake City Police Department

SLCPD Policy Manual

SLCPD Policy Manual

Vehicle Maintenance

- (d) The rear window and rear side windows do not allow less than 28% light transmittance.
- (e) Officers shall obtain a sample of, and mandated standards for, approved tint from the Police Fleet Coordinator prior to having tint installed. The sample and mandated standards shall be presented to the vendor as the only approved tint.
- (f) Materials and installation costs are provided at the expense of the officer.
 - 1. Vehicle assignment changes remain at the discretion of the Department and will not be cause for reimbursement of window tint costs incurred by the officer.
 - 2. If a window is damaged and must be replaced, the Department will provide for the tint material and installation to the replacement window. Damage caused by normal wear and tear is the responsibility of the officer assigned the vehicle, as outlined below.
 - 3. If an officer is assigned a car with tint that is bubbling or peeling, or otherwise does not meet standards, the officer must replace the tint to standards at their own cost, or have the tint removed at the Fleet Shops.
- (g) Window tint will be inspected for meeting standards as part of normal inspections by supervisors (see the Inspections of Critical Equipment, Vehicles, and Uniforms Procedure).

Installed tint that varies from this standard may be approved by the Chief of Police or designee in conjunction with vehicle build cycles.

702.2.2 DAMAGE

Vehicles that have been damaged shall be removed from service for inspections and repairs as soon as practicable. Proper procedure for reporting damage shall be followed. [Salt Lake City Police Department Procedure Manual: 702.4 DAMAGED VEHICLE REPORTING](#)

When any department vehicle is involved in a traffic collision or otherwise incurs damage, the involved member shall promptly notify a supervisor. Collision reports shall be filed in accordance with the Traffic Collision Reporting Policy and Procedure. Damage to any department vehicle that was not caused by a traffic collision shall be immediately reported during the shift in which the damage was discovered.

702.2.3 REMOVAL OF WEAPONS

All firearms and weapons shall be removed from a vehicle and properly secured prior to the vehicle being released for maintenance, service, or repair.

702.2.4 VEHICLE INTERIOR BIOHAZARD REMOVAL

The City has a contract with a private company for removal of bodily fluids and other biohazard substances from vehicle interiors. This service should be used for significant cleanings when the officer cannot reasonably clean the affected area of the vehicle using personal protective equipment and common cleaning supplies.

Employees will obtain supervisor approval prior to calling for a cleaning response.

Salt Lake City Police Department

SLCPD Policy Manual

SLCPD Policy Manual

Vehicle Maintenance

The company will respond to the officer's location upon request through Dispatch. The requesting officer will provide the cleaning technician with their name, vehicle number, and associated case number for notation on the company's invoice.

702.3 VEHICLE REFUELING

The primary fuel facility for police vehicles is the Fleet Shops. Alternative facilities are located at various locations throughout the city, and are identified on Fleet's intranet site.

Refueling should be done on-duty.

Members shall take due care when refueling. If damage is sustained to fueling apparatus members shall:

- (a) Notify an on-duty supervisor.
- (b) Complete an initial report documenting the damage to City equipment.
- (c) Complete a Damage to City Property Form.
- (d) Complete a memorandum detailing the incident.
- (e) Forward all reports, forms, and memorandums through the chain of command to the member's Division Commander.

The on-duty supervisor notified of damage to fueling apparatus shall respond to the scene and complete a complaint entry in BlueTeam. The supervisor shall photograph the damage on a department-issued phone. The photograph and a copy of the Damage to City Property Form shall be attached to the BlueTeam entry.

702.4 WASHING AND CLEANLINESS OF VEHICLES

All vehicles shall be kept clean at all times, and weather conditions permitting, shall be washed as necessary to enhance their appearance.

Employees using a vehicle shall remove any trash or debris at the end of their shift. Confidential material should be placed in a designated receptacle provided for the shredding of this matter.

702.5 REVISIONS

Enacted: April 23, 2018

Revised: May 3, 2018

Revised: December 17, 2018

Vehicle Use

703.1 PURPOSE AND SCOPE

The purpose of this policy is to establish a system of accountability to ensure department vehicles are used appropriately. This policy provides guidelines for on- and off-duty use of department vehicles.

703.2 POLICY

The Salt Lake City Police Department provides vehicles for department-related business use and may assign patrol and unmarked vehicles based on a determination of operational efficiency, economic impact to the Department, requirements for tactical deployments and other considerations.

703.3 USE OF VEHICLES

703.3.1 INSPECTIONS

The interior of any vehicle that has been used to transport any person other than a member of this department should be inspected at the beginning of shift and prior to placing another person in the vehicle and again after the person is removed. This is to ensure that unauthorized or personal items have not been left in the vehicle.

Sergeants shall make trimesterly inspections of vehicles assigned to officers and detectives under their command to ensure the vehicles are being maintained in accordance with Department policy. These inspections shall follow proper procedure as outlined in the Inspections of Critical Equipment, Vehicles, and Uniforms Procedure.

[Salt Lake City Police Department Procedure Manual: 706.1 PURPOSE AND SCOPE](#)

[Salt Lake City Police Department Procedure Manual: 706.2 PROCEDURE](#)

All department vehicles are subject to inspection and/or search at any time by a supervisor without notice and without cause. No member assigned to or operating such vehicle shall be entitled to any expectation of privacy with respect to the vehicle or its contents.

703.3.2 SECURITY AND UNATTENDED VEHICLES

Unattended vehicles should be locked and secured at all times. No key should be left in the vehicle except when it is necessary that the vehicle be left running (e.g., continued activation of emergency lights, canine safety, equipment charging).

Members shall ensure all weapons are secured while the vehicle is unattended.

703.3.3 MOBILE DATA TERMINAL

Members assigned to vehicles equipped with a Mobile Data Terminal (MDT) shall log onto the MDT with the required information when going on-duty. If the vehicle is not equipped with a working MDT, the member shall notify Dispatch. Use of the MDT is governed by the Mobile Data Terminal Use Policy.

Salt Lake City Police Department

SLCPD Policy Manual

SLCPD Policy Manual

Vehicle Use

703.3.4 VEHICLE LOCATION SYSTEM

Patrol and other vehicles, at the discretion of the Chief of Police, may be equipped with a system designed to track the vehicle's location. While the system may provide vehicle location and other information, members are not relieved of their responsibility to use required communication practices to report their location and status.

Members shall not make any unauthorized modifications to the system or disable it. At the start of each shift, members shall verify that the system is on and report any malfunctions to their supervisor. If the member finds that the system is not functioning properly at any time during the shift, he/she should follow the procedures for submitting the malfunctioning equipment to IMS. Salt Lake City Police Department Procedure Manual: 700.2 IMS ASSISTANCE REQUEST

System data may be accessed by supervisors at any time. However, access to historical data by personnel other than supervisors will require Division Commander approval. All data captured by the system shall be retained in accordance with the established records retention schedule.

703.3.5 ALCOHOL

Members who have consumed alcohol are prohibited from operating any department vehicle unless it is required by the duty assignment (e.g., task force, undercover work). Regardless of assignment, members may not violate state law regarding vehicle operation while intoxicated.

The unauthorized possession of alcohol by any member in a City-owned vehicle is prohibited.

703.3.6 PARKING

Except when responding to a call for service or when department-related business requires otherwise, members driving department vehicles should obey all parking regulations at all times. If an employee receives a citation for parking illegally when not responding to a call for service or when department-related business required otherwise, the employee will be responsible for that citation.

Department vehicles should be parked in marked stalls at police facilities. Members shall not park privately owned vehicles in stalls assigned to department vehicles or in other areas of the parking lot that are not so designated unless authorized by a supervisor. Privately owned motorcycles shall be parked in designated areas at police facilities.

703.3.7 NON-SWORN MEMBER USE

Non-sworn members shall not operate the emergency lights or siren of any vehicle unless expressly authorized by a sworn officer. Non-sworn members will also be required to carry proper identification, including a department issued ID card.

703.4 MEMBER ASSIGNMENT TO VEHICLES

Vehicles may be assigned for on-duty and/or take-home use. Assigned vehicles may be changed at any time. Permission to take home a vehicle may be withdrawn at any time.

The assignment of vehicles may be suspended when the member is unable to perform his/her regular assignment.

Salt Lake City Police Department

SLCPD Policy Manual

SLCPD Policy Manual

Vehicle Use

When a member is notified that a vehicle is no longer assigned to them, the member must clean and restore the vehicle to a condition acceptable to the Fleet Coordinator.

703.4.1 DRIVING HABITS

Vehicles may be reassigned or utilized by other department members at the discretion of the Chief of Police or the authorized designee. Employees shall operate police vehicles in a careful and prudent manner and shall set a proper example in driving habits.

703.5 TAKE-HOME VEHICLES

The Chief of Police or designee may authorize take-home use of City owned vehicles, and qualifying employees may participate in the Department's take-home car program.

Criteria for use, and participation in, the take-home car program include the following:

- (a) Only Department employees may operate City-owned vehicles.
- (b) Vehicles may be used to transport the employee to and from the employee's residence for work-related and secondary employment (if the secondary employer has complied with the ordinance requiring the fuel surcharge per work shift of the police officer) purposes.
- (c) For employees who live in Salt Lake City, reasonable personal use of the vehicle is available within Salt Lake County.
- (d) For employees who live outside Salt Lake City, reasonable personal use of the take home vehicle is available within Salt Lake County and the county in which the employee resides.
- (e) Under no circumstances shall a City-owned vehicle be authorized for take-home use for an employee who resides farther than thirty-five (35) miles from City limits.
- (f) While operating the vehicle, authorized members will carry and have accessible a duty handgun.
- (g) Window decals, ornaments hanging from the windshield mirror, bumper stickers or other signs, pictures, and ornaments visible to the public and attached to a police vehicle are prohibited.
- (h) City-owned vehicles will not be utilized for carrying heavy or excessive loads and will not have objects protruding from the trunks or windows.
- (i) The two-way communications radio, if equipped, must be on and set to an audible volume when the vehicle is in operation.
- (j) Unattended vehicles are to be locked and secured at all times.
- (k) All firearms, weapons, portable radios, and MDTs will be removed from the interior of the vehicle and properly secured in an employee's residence when the vehicle is not attended, unless the vehicle is parked in a locked garage.
- (l) Mileage accumulation will be reviewed by the police administration.

Salt Lake City Police Department

SLCPD Policy Manual

SLCPD Policy Manual

Vehicle Use

Refer to the take-home car program procedure for details on take-home vehicle assignment. [Salt Lake City Police Department Procedure Manual: 702.6 TAKE-HOME CAR PROGRAM PROCEDURE](#)

703.5.1 EMPLOYEES NOT PARTICIPATING IN THE TAKE-HOME CAR PROGRAM

Employees who do not participate in the take-home car program will be assigned a fleet police vehicle for use while on duty or for secondary employment, based on vehicle availability.

For those employees who work at the Public Safety Building, pool vehicles (located in the City Library parking garage) will be available for check out utilizing the reservation system used by Fleet (Refer to Fleet's intranet site for instructions on how to reserve a pool vehicle).

All employees assigned a fleet vehicle are responsible for completing work orders and delivering the fleet police vehicle to the proper location for needed repairs.

703.5.2 LOANER VEHICLES

For those employees who participate in the take-home car program, a number of vehicles designated as loaner vehicles are available for temporary use while their assigned vehicle is being serviced or repaired. The loaner vehicles can be checked out via the Fleet Shops when available.

Employees who are assigned a marked vehicle should only check out a marked loaner. Employees who are assigned an unmarked vehicle should only check out an unmarked loaner. Exceptions may be granted through the Fleet Coordinator.

Before returning a loaner vehicle it will be fueled and cleaned. The loaner vehicle and keys will be returned to the Fleet Shops the same day the employee regains the use of their assigned vehicle.

Employees using a loaner vehicle are responsible for completing work orders for vehicles needing repairs.

703.5.3 UNSCHEDULED TAKE-HOME USE

Circumstances may arise where department vehicles must be used by members to commute to and from a work assignment even though the member does not participate in the take-home car program. Members may take home department vehicles only with prior approval of a supervisor and shall meet the following criteria:

- (a) The circumstances are unplanned and were created by the needs of the Department.
- (b) Other reasonable transportation options are not available.
- (c) The member lives within a reasonable distance (generally not to exceed a 60-minute drive time) of the City limits.
- (d) Vehicles will be locked when not attended.
- (e) All firearms, weapons, portable radios, and MDTs will be removed from the interior of the vehicle and properly secured in the member's residence when the vehicle is not attended, unless the vehicle is parked in a locked garage.

Salt Lake City Police Department

SLCPD Policy Manual

SLCPD Policy Manual

Vehicle Use

703.6 ATTIRE AND APPEARANCE

When operating any department vehicle while off-duty, members may dress in a manner appropriate for their intended activity. Whenever in view of or in contact with the public, attire, appearance, and behavior, regardless of the activity, should be suitable to reflect positively upon the Department.

703.7 VEHICLE EQUIPMENT

Each department-owned vehicle that is used for official police duties shall be equipped with:

- (a) Emergency lights
- (b) A department radio
- (c) Fire extinguisher
- (d) Public announcement system
- (e) Spare tire and jack (if the vehicle is originally equipped with them)

Members will contact the Fleet Coordinator if any of the above equipment is missing or needs replacement.

703.8 REVISIONS

Enacted: April 23, 2018

Revised: May 3, 2018

Revised: May 16, 2018

Revised: May 21, 2018

Cash Handling, Security and Management

704.1 PURPOSE AND SCOPE

This policy provides guidelines to ensure department members handle cash and Purchase Card (P-card) transactions appropriately in the performance of their duties.

This policy does not address cash-handling issues specific to the Evidence and Property Packaging Procedure.

704.2 POLICY

It is the policy of the Salt Lake City Police Department to properly handle and document cash transactions and to maintain accurate records of cash transactions in order to protect the integrity of department operations and ensure the public trust. The documentation and audit procedures shall, at a minimum, follow those established in the Salt Lake City Financial Services policies and procedures.

704.3 PURCHASE CARDS (P-CARDS)

Depending on a member's assignment, they may be issued a Purchase Card (P-card). This card has replaced most cash transactions for the Department and can handle purchases up to \$2,500. Purchase Cards may not be used for purchases at Amazon or Costco unless the cardholder has been added as an authorized account holder for these vendors by the City. Purchases via P-cards that require shipping must be shipped directly to a Police Department location. The P-card usage is governed by the City's Procurement Card Policy, which can be found in City policy and procedure, or this department's Cash Handling, Security and Management Procedure.

704.4 ROUTINE CASH HANDLING

The only cash disbursements authorized by the Department are for informant-related payments, reward payments, and undercover operations expenses. Those who disburse these cash payments shall discharge those duties in accordance with the Informants, Rewards, and Undercover Operations Expenses Procedure (Refer to the Informants, Rewards, and Undercover Operations Expenses Procedure for those personnel who are authorized for such disbursements.).

Members who routinely accept payment for Department services shall discharge those duties in accordance with the procedures established for those tasks. Members in the following units, after being authorized by the City Treasurer's Office, are the only individuals authorized to accept cash payments.

- (a) Quartermaster's Office
- (b) Finance Unit
- (c) Records Unit
- (d) Sex Offender Registry
- (e) DEA Metro Narcotics Task Force

Salt Lake City Police Department

SLCPD Policy Manual

SLCPD Policy Manual

Cash Handling, Security and Management

The manner in which these funds shall be handled will comply with the City's Cash Handling Procedures, as well as the Department's Cash Handling, Security and Management Procedure.

704.4.1 AUDITS

The Police Financial Services Unit will conduct quarterly auditing of agency cash activities.

704.5 OTHER CASH HANDLING

Members of the Department who, within the course of their duties, are in possession of cash that is not their property or that is outside their defined cash-handling responsibilities shall, as soon as practicable, verify the amount, summon another member to verify their accounting, and process the cash for safekeeping or as evidence or found property, in accordance with the Evidence and Property Packaging Procedure.

704.6 REVISIONS

Enacted: April 23, 2018

Revised April 16, 2019

Personal Protective Equipment

705.1 PURPOSE AND SCOPE

This policy identifies the different types of personal protective equipment (PPE) used by Department members as well as the requirements and guidelines for the use of PPE.

This policy does not address ballistic vests or protection from communicable disease, as those issues are addressed in the Body Armor and Communicable Diseases policies.

705.1.1 DEFINITIONS

Definitions related to this policy include:

Personal protective equipment (PPE) - Equipment that protects a person from serious workplace injuries or illnesses resulting from contact with chemical, radiological, physical, electrical, mechanical or other workplace hazards.

Respiratory PPE - Any device that is worn by the user to protect from exposure to atmospheres where there is smoke, low levels of oxygen, high levels of carbon monoxide, or the presence of toxic gases or other respiratory hazards. For purposes of this policy, respiratory PPE does not include particulate-filtering masks such as N95 or N100 masks.

705.2 POLICY

The Salt Lake City Police Department endeavors to protect members by supplying certain PPE to members as provided in this policy.

705.3 OFFICER RESPONSIBILITIES

Members are required to use PPE as provided in this policy and pursuant to their training.

Members are responsible for proper maintenance and storage of issued PPE. PPE should be stored in an appropriate location so that it is available when needed.

705.4 HEARING PROTECTION

Approved hearing protection shall be used by members during firearms training. While the Training Unit may have hearing protection available at firearms training, all members are ultimately responsible for providing their own hearing protection.

705.5 EYE PROTECTION

Approved eye protection shall be used by members during firearms training. Eye protection for members who wear prescription lenses shall incorporate the prescription (e.g., eye protection that can be worn over prescription lenses). Members shall ensure their eye protection does not interfere with the fit of their hearing protection.

While the Training Unit may have eye protection available at firearms training, all members are ultimately responsible for providing their own eye protection. The exception to this is for officers assigned to Motors or SWAT; specific eye protection is provided as a part of those assignments.

Salt Lake City Police Department

SLCPD Policy Manual

SLCPD Policy Manual

Personal Protective Equipment

705.6 HEAD AND BODY PROTECTION

All sworn members should be provided ballistic head protection with an attachable face shield.

In addition, members assigned to the Public Order Unit (POU) should be provided padded body protection consisting of chest, arm, leg and groin protection.

705.7 RESPIRATORY PROTECTION

The Quartermaster supervisor is responsible for ensuring a respiratory protection plan is developed and maintained. The plan shall include procedures for (29 CFR 1910.134; UAC R614-1-4):

- (a) Selecting appropriate respiratory PPE based on hazards and risks associated with functions or positions.
- (b) PPE inventory control.
- (c) PPE issuance and replacement.
- (d) Cleaning, disinfecting, storing, inspecting, repairing, discarding and otherwise maintaining respiratory PPE, including schedules for these activities.
- (e) Remaining current with applicable National Institute for Occupational Safety and Health (NIOSH), American National Standards Institute (ANSI), Occupational Safety and Health Administration (OSHA), Environmental Protective Agency (EPA) and state PPE standards and guidelines.

705.7.1 RESPIRATORY PROTECTION USE

Designated members may be issued respiratory PPE based on the member's assignment.

Scene commanders are responsible for monitoring members using respiratory PPE and their degree of exposure or stress. When there is a change in work area conditions or when a member's degree of exposure or stress may affect respirator effectiveness, the scene commander shall reevaluate the continued effectiveness of the respirator and direct the member to leave the respirator use area when the scene commander reasonably believes (29 CFR 1910.134; UAC R614-1-4):

- (a) It is necessary for the member to wash his/her face and the respirator facepiece to prevent eye or skin irritation associated with respirator use.
- (b) The member detects vapor or gas breakthrough, or there is a change in breathing resistance or leakage of the facepiece.
- (c) The member needs to replace the respirator, filter, cartridge or canister.

705.7.2 MEMBER RESPONSIBILITIES FOR RESPIRATORY PROTECTION

Members shall not use self-contained breathing apparatus (SCBA), full-face respirators or cartridge respirators unless they have completed training requirements for the equipment.

Members exposed to environments that are reasonably known to be harmful due to gases, smoke or vapors shall use respiratory PPE.

Members using respiratory PPE shall (29 CFR 1910.134; UAC R614-1-4):

Salt Lake City Police Department

SLCPD Policy Manual

SLCPD Policy Manual

Personal Protective Equipment

- (a) Ensure that they have no facial hair between the sealing surface of the facepiece and the face that could interfere with the seal or the valve function. Members also shall ensure that they have no other condition that will interfere with the face-to-facepiece seal or the valve function.
- (b) Not wear corrective glasses, goggles or other PPE that interferes with the seal of the facepiece to the face, or that has not been previously tested for use with that respiratory equipment.
- (c) Perform a user seal check per department-approved procedures recommended by the respirator manufacturer each time they put on a tight-fitting respirator.
- (d) Leave a respiratory use area whenever they detect vapor or gas breakthrough, changes in breathing resistance or leakage of their facepiece and ensure that the respirator is replaced or repaired before returning to the affected area.

705.7.3 GAS MASK

Full-face air-purifying respirators, commonly referred to as gas masks, may be fitted with mechanical pre-filters or combination cartridge/filter assemblies for use in areas where gases, vapors, dusts, fumes or mists are present. Members must identify and use the correct cartridge based on the circumstances (29 CFR 1910.134; UAC R614-1-4).

A scene commander may order the use of gas masks in situations where the use of a SCBA is not necessary. These incidents may include areas where tear gas has or will be used. Gas masks shall not be used if there is a potential for an oxygen-deficient atmosphere.

Members shall ensure their gas mask filters are replaced whenever:

- (a) They smell, taste or are irritated by a contaminant.
- (b) They experience difficulty breathing due to filter loading.
- (c) The cartridges or filters become wet.
- (d) The expiration date on the cartridges or canisters has been reached.

705.7.4 SELF-CONTAINED BREATHING APPARATUS

Scene commanders may direct members to use SCBA when entering an atmosphere that may pose an immediate threat to life, would cause irreversible adverse health effects or would impair an individual's ability to escape from a dangerous atmosphere. These situations may include, but are not limited to:

- (a) Entering the hot zone of a hazardous materials incident.
- (b) Entering any area where contaminant levels may become unsafe without warning, or any situation where exposures cannot be identified or reasonably estimated.
- (c) Entering a smoke- or chemical-filled area.

The use of SCBA should not cease until approved by a scene commander.

All SCBA's are dispersed and managed by the SWAT Lieutenant.

Salt Lake City Police Department

SLCPD Policy Manual

SLCPD Policy Manual

Personal Protective Equipment

705.7.5 RESPIRATOR FIT TESTING

No member shall be issued respiratory PPE until a proper fit testing has been completed by a designated member or contractor (29 CFR 1910.134; UAC R614-1-4).

705.8 RECORDS

The Quartermaster supervisor is responsible for maintaining records of all department-wide PPE training for sworn members. Specialized units (e.g., SWAT, POU, etc.) will maintain training records for unit PPE training.

705.9 TRAINING

Members should be trained in the respiratory and other hazards to which they may be potentially exposed during routine and emergency situations.

All members shall be trained in the proper use and maintenance of PPE issued to them, including when the use is appropriate; how to put on, remove and adjust PPE; how to care for the PPE; and the limitations (29 CFR 1910.132; UAC R614-1-4).

705.10 REVISIONS

Enacted: April 23, 2018

Authorized Personal Use of Public Property

706.1 PURPOSE AND SCOPE

This policy provides public servants guidance as to authorized personal use of public property, as defined in Utah Code section 76-8-101(5), to help them avoid unintentional violations of Utah Code sections 76-8-402 and 404, Offenses Against the Administration of Government. Violation of Utah Code section 76-8-402 is a felony.

A public servant is not guilty of a violation of Utah Code section 76-8-402 if personal use of public property is authorized by the public entity.

Definitions:

“Public servant” means a public officer, an appointed official, employee, consultant, or independent contractor of a public entity, or a person hired or paid by a public entity to perform a government function.

“Public property” means real or personal property that is owned, held, or managed by a public entity.

This policy constitutes a “written policy of the public servant’s entity” for purposes of Utah Code section 76-8-402(1)(b)(iii). For purposes of this policy, “public servants” will be referred to as “employees”.

706.2 USE OF PUBLIC PROPERTY

Employees are responsible to protect and conserve government owned or leased property and use official time in an honest effort to perform official duties. This policy does not grant to employees or create an inherent right to use government resources, and one should not be inferred. The privilege to use public property for personal purposes may be limited or revoked at any time by the employees supervisor. Employees who have questions regarding the application of this policy or the guidelines contained herein are encouraged to seek clarification from supervisory personnel.

Employees do not have a right to nor should they have an expectation of privacy while using government resources at any time including when they are accessing the internet, using email, instant messaging, or telephones- see Personal Communications Devices policy. Employees who wish for their personal activities to be private should not conduct such activities using public property.

All property owned, held, leased, or managed by the Department shall only be used by those to whom it was assigned. Use of public property should be limited to official purposes and in the capacity for which it was designed. Infrequent and incidental personal use of public property is permissible if limited in scope and frequency, and in conformance with the other elements of the applicable policy.

Salt Lake City Police Department

SLCPD Policy Manual

SLCPD Policy Manual

Authorized Personal Use of Public Property

To help improve the effectiveness and efficiency of government services, incidental personal use of public property is authorized under Utah Code section 76-8-402 and is further authorized under this policy. Incidental personal use includes:

- (a) Use of public property for limited personal use when an employee is using the public property to perform their duties of office or employment; and
- (b) Use of public property of a personal nature when such use of the public property:
 - Is allowed to be used by the general public;
 - Is allowed for training or skill development;
 - Is provided or required to be provided to the public servant as an employee benefit or convenience, such as lunchroom, fitness, and/or nursing room facilities;
 - Provides value to the Department that substantially outweighs the personal benefit received by the employee;
 - Is otherwise permitted by an employee's manager or supervisor in writing prior to usage; or
 - Is otherwise permissible under state, federal, or municipal law.
- (c) Notwithstanding (2), incidental personal use does not include any use that:
 - Significantly interferes with the mission or operations of the Department;
 - Significantly interferes with the performance of the employee's or any other employee's official duties;
 - Significantly compromises the integrity of public property; or
 - Is for private financial gain, including but not limited to conducting outside business, employment, or other income generating activities.

706.3 CORRELATING DIRECTIVES

This policy does not modify the requirements of laws, rules, or policies regulating the employees' use of public property, including but not limited to the following:

Code of Ethics

205 Electronic Mail

301 Handcuffing and Restraints

302 Control Devices and Techniques

303 Conducted Energy Device

305 Firearms

308 Canines

321 Standards of Conduct

Salt Lake City Police Department

SLCPD Policy Manual

SLCPD Policy Manual

Authorized Personal Use of Public Property

322 Information Technology Use

339 Off-Duty Law Enforcement Actions

407 Special Weapons and Tactics (SWAT) Team

421 Mobile Data Terminal Use

422 Portable Audio/Video Recorders

424 Bicycle Patrol Unit

500 Traffic Function and Responsibility

700 Department-Owned and Personal Property

701 Personal Communication Devices

703 Vehicle Use

705 Personal Protective Equipment

1010 Body Armor

1018 Communicable Diseases

1021 Uniform Regulations

1024 Department Badges

1027 Employee Speech, Expression, and Social Networking

Procedure 203 Pioneer Precinct Gun Range

Procedure 702 Department Vehicle Procedures

Procedure 800 Radio Communications Procedures

Procedure 1005 Uniform and Equipment Issuance/Purchasing Procedures

706.4 REVISIONS

Enacted: June 27, 2019

Chapter 8 - Support Services

Crime Analysis

800.1 PURPOSE AND SCOPE

Crime analysis should provide currently useful information to aid operational personnel in meeting their tactical crime control and prevention objectives by identifying and analyzing methods of operation of individual criminals, providing crime pattern recognition and providing analysis of data from field interrogations and arrests. Crime analysis can be useful to the Department's long-range planning efforts by providing estimates of future crime trends and assisting in the identification of enforcement priorities.

800.2 DATA SOURCES

Crime analysis data is extracted from many sources including, but not limited to:

- The department's records management system (RMS)
- Public information sources
- Utah Criminal Justice Information System (UCJIS)
- Criminal Justice Information System (CJIS)
- Private research databases
- State, county, and city databases
- Palantir

800.3 CRIME ANALYSIS FACTORS

The following minimum criteria should be used in collecting data for crime analysis:

- Frequency
- Geographic factors
- Temporal factors
- Victim and target descriptors
- Suspect descriptors
- Suspect vehicle descriptors
- Modus operandi factors
- Evidence information

800.4 CRIME ANALYSIS DISSEMINATION

For a crime analysis system to function effectively, information should be disseminated to the appropriate units or persons on a timely basis. Information that is relevant to the operational and tactical plans of specific line units should be sent directly to them. Information relevant to the development of the Department's strategic plans should be provided to the appropriate staff units. When information pertains to tactical and strategic plans, it should be provided to all affected units.

Salt Lake City Police Department

SLCPD Policy Manual

SLCPD Policy Manual

Crime Analysis

800.4.1 ADVISING THE CHIEF

The Chief of Police or their designee regularly meets with Command Staff to discuss crime trends, received intelligence, and special events. Moreover, the Chief of Police receives a weekly report generated from the Salt Lake Information Center (SLIC) on crime trends and suspected offenders. For special cases where direct threats to the public or police department are made, the SLIC will create a special report on the nature of the threat(s) and submit the report to the Chief for review.

800.5 REVISIONS

Enacted: April 23, 2018

Dispatch

801.1 PURPOSE AND SCOPE

This policy establishes guidelines for the basic functions of Dispatch. It addresses the immediate information needs of the Department in the course of its normal daily activities and during emergencies.

801.2 POLICY

It is the policy of the Salt Lake City Police Department to provide 24-hour telephone service to the public for information and for routine or emergency assistance. The Department provides two-way radio capability for continuous communication between Dispatch and department members in the field. Unless directed otherwise (e.g., motor squad, undercover operations, etc.), field personnel should notify dispatch of their location when undertaking any enforcement, investigatory, and or traffic-related actions.

801.3 FEDERAL COMMUNICATIONS COMMISSION COMPLIANCE

Salt Lake City Police Department radio operations shall be conducted in accordance with Federal Communications Commission (FCC) procedures and requirements.

801.4 DISPATCH SECURITY

The communications function is vital and central to all emergency service operations. The safety and security of Dispatch, its members, and its equipment must be a high priority.

Dispatch is located in a restricted area. Access to Dispatch shall be limited to Dispatch members, the Watch Commander, Command Staff, and department members with a specific business-related purpose.

801.5 RESPONSIBILITIES

801.5.1 DISPATCH SUPERVISOR

The responsibilities of a Dispatch supervisor include, but are not limited to:

- (a) Overseeing the efficient and effective operation of Dispatch in coordination with other supervisors.
- (b) Scheduling and maintaining dispatcher time records.
- (c) Supervising, training and evaluating dispatchers.
- (d) Ensuring the radio and telephone recording system is operational.
 - (a) Recordings shall be maintained in accordance with the established records retention schedule and as required by law.
- (e) Maintaining Dispatch database systems.
- (f) Maintaining and updating the Dispatch procedure manual.
 - (a) Ensuring dispatcher compliance with established policies and procedures.

Salt Lake City Police Department

SLCPD Policy Manual

SLCPD Policy Manual

Dispatch

- (g) Handling internal and external inquiries regarding services provided and accepting personnel complaints.
- (h) Ensuring a protocol is in place to contact the City's Emergency Management Team in the event of a utility service emergency.

801.5.2 ADMINISTRATIVE ASSISTANT

The Administrative Assistant is responsible for:

- (a) Recording all telephone and radio communications and playback issues.
- (b) Storage and retention of recordings.
 - 1. Recordings shall be stored for a minimum of 90 days.
- (c) Security of audio recordings (e.g., passwords, limited access, authorized reviewers, preservation of recordings past normal retention standards).
 - 1. Storage of recordings shall be password protected.
 - 2. Only authorized department members may review recordings and only for investigative purposes. In emergency or time-sensitive situations, authorized personnel should contact a Dispatch supervisor to review a recording. Otherwise, authorized personnel should contact the Dispatch Administrative Assistant. All other requests will be made through a GRAMA request.
- (d) Availability of current information for dispatchers (e.g., Watch Commander contact, rosters, member tracking methods, member contact, maps, emergency providers, tactical dispatch plans).

801.5.3 DISPATCHERS

Dispatchers report to the Dispatch Supervisor. The responsibilities of the dispatcher include, but are not limited to:

- (a) Receiving and handling all incoming and transmitted communications, including:
 - (a) Emergency 9-1-1 lines.
 - (b) Business telephone lines.
 - (c) Telecommunications Device for the Deaf (TDD)/Text to 911 equipment. (See Communications with Persons with Disabilities Policy)
 - (d) Radio communications with department members in the field and support resources (e.g., fire department, emergency medical services (EMS), allied agency law enforcement units).
 - (e) Other electronic sources of information (e.g., text messages, digital photographs, video).
- (b) Assignment of field members and safety check intervals.
- (c) Emergency Medical Dispatch (EMD) instructions.
- (d) Procurement of external services (e.g., fire suppression, ambulances, aircraft, tow trucks, taxis).

Salt Lake City Police Department

SLCPD Policy Manual

SLCPD Policy Manual

Dispatch

- (e) Handling misdirected, silent and hang-up calls.
- (f) Handling private security alarms, if applicable.
- (g) Radio interoperability issues.
- (h) Documenting the field activities of department members and support resources (e.g., fire department, EMS, allied agency law enforcement units).
- (i) Inquiry and entry of information through Dispatch, department and other law enforcement database systems (e.g., Department of Motor Vehicle (DMV) records, the Utah Criminal Justice Information System (UCJIS) and NCIC).
- (j) Maintaining the current status of members in the field, their locations and the nature of calls for service.
- (k) Notifying the Watch Commander or field supervisor of emergency activity, including, but not limited to:
 - (a) Vehicle pursuits.
 - (b) Foot pursuits.
 - (c) Assignment of emergency response.
 - (d) Any other incident that may require the Watch Commander or field supervisor to respond and assume command.

801.6 CALL HANDLING

This department provides members of the public with access to the 9-1-1 system for a single emergency telephone number.

When a call for services is received, the dispatcher will reasonably and quickly attempt to determine whether the call is an emergency or non-emergency, and shall quickly ascertain the call type, location, and priority.

Dispatchers will prioritize calls from 1-4 based on the information received:

- Priority 1 Calls
 - These are calls requiring immediate attention. They include in-progress crimes, major crimes just occurred with a time lapse of five minutes or less for property crimes and fifteen minutes or less for crimes against a person, and non-criminal situations of an emergency nature.
- Priority 2 Calls
 - Minor crimes just occurred, or calls requiring immediate attention.
- Priority 3 Calls
 - Non-emergency calls requiring prompt attention.
- Priority 4 Calls
 - These are service and investigative calls requiring an officer to respond to the scene.

Salt Lake City Police Department

SLCPD Policy Manual

SLCPD Policy Manual

Dispatch

Telephonic calls are incidents which can be handled over the phone and do not require an officer to respond to the scene.

Dispatchers should be courteous, patient and respectful when dealing with the public.

801.6.1 EMERGENCY CALLS

A call is considered an emergency when there is an immediate or potential threat to life and the timely arrival of public safety assistance is of the utmost importance. A person reporting an emergency should not be placed on hold until the dispatcher has obtained all necessary information to ensure the safety of the responding department members and affected individuals.

Emergency calls should be dispatched immediately. The Watch Commander shall be notified of pending emergency calls for service when department members are unavailable for dispatch. Call takers will advise the caller if an officer will be dispatched to the scene or whether the response will be delayed.

801.6.2 NON-EMERGENCY CALLS

A call is considered a non-emergency call when there is no immediate or potential threat to life or property. A person reporting a non-emergency may be placed on hold, if necessary, to allow the dispatcher to handle a higher priority or emergency call.

The reporting person should be advised if there will be a delay in the dispatcher returning to the telephone line or when there will be a delay in the response for service.

801.6.3 VICTIM OR WITNESS REQUESTS FOR INFORMATION

When responding to victim/witness requests for information and/or services, to include initial and subsequent requests, dispatchers will:

- (a) Determine what the caller wants or is asking for.
 1. This includes judging characteristics of the call to determine whether it is an emergency or non-emergency.
- (b) Advise the caller that if department members can assist with their request they will, and provide the caller with the information or services they are requesting.
- (c) If the caller's request cannot be handled by this department, transfer the caller to the appropriate agency for service.

801.6.4 EMERGENCY MESSAGES

Citizens, businesses, emergency providers, hospital personnel, and other law enforcement agencies may contact the Department and request that we notify individuals believed to be in Salt Lake City about an emergency situation. Upon receiving this request, dispatch shall create a call categorizing it as a high priority, and sending the next available officer to deliver the message.

801.6.5 MISDIRECTED EMERGENCY CALLS

When a misdirected emergency call is received, dispatchers shall promptly handle the call by gathering necessary information and also advising the caller of necessary information.

Salt Lake City Police Department

SLCPD Policy Manual

SLCPD Policy Manual

Dispatch

Dispatchers shall route the call to the appropriate agency via a CAD interface. If a CAD interface is not available, a conference call shall be utilized.

801.7 MEMBER TELEPHONE NUMBERS AND ADDRESSES

Telephone numbers and addresses of Department employees shall not be released to the public. Messages shall be relayed to the employee or referred to the Division secretaries, the administrative offices, or the employee's immediate supervisor.

Telephone numbers and addresses of employees shall only be released to other employees of the Department who have been properly identified by Department IBM.

801.8 DOCUMENTATION

It shall be the responsibility of Dispatch to document all relevant information on calls for service, including citizen reports of crimes or complaints, or self-initiated activity in the CAD (computer-assisted dispatching) system. Dispatchers shall attempt to elicit, document and relay as much information as possible to enhance the safety of the member and assist in anticipating conditions that may be encountered at the scene. The desirable information would include, at a minimum:

- Incident control number.
- Date and time of the request.
- Name and address of the reporting person, if possible.
- Type of incident reported.
- Involvement of weapons, drugs and/or alcohol.
- Location of the incident reported.
- Identification of members assigned to primary and backup roles.
- Time of dispatch.
- Time of the responding member's arrival.
- If an arrest was made or citation issued.
- Time of member's return to service.
- Disposition or status of the reported incident.

801.9 CONFIDENTIALITY

Information that becomes available through Dispatch may be confidential or sensitive in nature. All members of Dispatch shall treat information that becomes known to them as confidential and only release that information in accordance with the Protected Information Policy.

Automated data, such as DMV records, warrants, criminal history information, records of internal police files or medical information, shall only be made available to authorized law enforcement personnel.

Salt Lake City Police Department

SLCPD Policy Manual

SLCPD Policy Manual

Dispatch

801.10 REVISIONS

Enacted: April 23, 2018

Property and Evidence Chain of Custody

802.1 PURPOSE AND SCOPE

This policy provides for the proper documentation of the chain of custody with property and evidence.

802.2 DEFINITIONS

Definitions related to this policy include:

Cohabitant - A person who is 18 years of age or older, who resides in the same residence as the owner cohabitant, and is any of the following (Utah Code 53-5c-201).

- Living as if a spouse of the owner cohabitant.
- Related by blood or marriage to the owner cohabitant.
- Has one or more children in common with the owner cohabitant.
- Has an interest in the safety and well-being of the owner-cohabitant.

Evidence - Includes items taken or recovered in the course of an investigation that may be used in the prosecution of a case. This includes photographs and latent fingerprints.

Found Property - Includes property found by an employee or citizen that has no apparent evidentiary value, and where the owner cannot be readily identified or contacted.

Owner cohabitant - A cohabitant who owns, in whole or in part, a firearm (Utah Code 53-5c-102).

Property - Includes all items of evidence, items taken for safekeeping, and found property.

Safekeeping - Includes the following types of property:

- Property obtained by the Department for safekeeping such as a firearm.
- Personal property of an arrestee not taken as evidence.
- Property taken for safekeeping under the authority of a law.

802.3 MAINTAINING THE CHAIN OF EVIDENCE

When evidence relating to a crime or possible crime is located, the officer shall properly record the description of such evidence, location found, and disposition. The officer will retain such property in their possession until it is properly tagged and placed into the designated property locker or storage room. The chain of custody is critical in the prosecution of a case. Evidence must be accounted for at all times if it is to be introduced in court.

A general offense report (G.O.) is required for any property booked into property and evidence custody. The G.O. should include the base information as outlined above regardless of whether the item is simply safekeeping or found property.

Where ownership can be established as to found property with no apparent evidentiary value, such property may be released to the owner without the need for booking. A Property Release

Salt Lake City Police Department

SLCPD Policy Manual

SLCPD Policy Manual

Property and Evidence Chain of Custody

Form must be completed to document the release of property not booked and the owner shall sign the form acknowledging receipt of the item(s). [See attachment: Property Release Form.pdf](#)

Officers desiring property for court shall contact the evidence technician at least one day prior to the court date and will provide a copy of their subpoena directing them to produce the evidence. If the property is needed for early morning court, the officer shall make arrangements with evidence technicians to have the necessary evidence placed in a temporary locker to be retrieved in the morning before court.

802.3.1 BOOKING PROPERTY

All property must be booked prior to the employee going off-duty unless otherwise approved by a supervisor. At no time will property from a case be stored in an officer's patrol vehicle overnight or taken home with them. If the property is needed for early morning court, the officer shall make arrangements with evidence technicians to have the necessary evidence placed in a temporary locker to be retrieved in the morning before court. Employees booking property should observe the following guidelines:

- (a) Complete the electronic Property Form describing each item of property separately, listing all serial numbers, owner's name, and other identifying information or markings.
- (b) Should package all property in a suitable container available for its size.
- (c) Mark the packaging of each item of evidence with the booking employee's IBM and/or initials, placing the markings over the tape edge used to seal the package (half on the tape and half on the package).
- (d) Print an electronic evidence/property tag and attach it to each package or envelope in which the property is stored.
- (e) Place the property in evidence lockers at the Public Safety Building or the property intake portion of the Evidence Warehouse.
- (f) When the property is too large to be placed in a locker, the item will be taken to the large evidence storage intake area located at Evidence Warehouse.

For specialized instructions for specific types of evidence refer to the Evidence and Property Packaging Procedure.

When items are booked into evidence for safekeeping, those items shall be labeled as such, properly tagged, and placed into the designated property locker or storage room.

802.4 REVISIONS

Enacted: April 23, 2018

Revised: August 30, 2022

Property and Evidence Management

803.1 PURPOSE AND SCOPE

This policy provides an overview of the Department's property and evidence management system. It includes details on the transfer, release, disposal, and security of property and evidence in the Department's custody. It also outlines the Department's evidence audit and inspection schedule.

803.2 RECORDING OF PROPERTY INTO EVIDENCE

The evidence technician receiving custody of evidence or property shall scan the item into evidence by designating a storage location that shall be notated in the property record. An evidence technician has the authority to reject a piece of evidence based on improper entry or for packaging that would jeopardize the safety of the technician, validity of the evidence for court, or violates packaging techniques established in the Evidence and Property Packaging Procedure.

An evidence technician will notify the officer who created the property report and the officer will have 10 business days to correct the issue. If the officer fails to respond, the officer's supervisor will be notified.

Any changes in the location of property held by the Salt Lake City Police Department shall be noted in the property section of the reporting system.

803.3 REQUEST FOR EVIDENCE TESTING

Request for analysis of items shall be completed on the appropriate forms and submitted to the evidence section. Requests may be submitted at any time after the booking of the property or evidence.

803.3.1 STATE CRIME LAB REQUESTS

Requests for analysis of narcotics by the State Crime Lab shall be completed by sending an email to evidencedrugtransportationrequests@slcgov.com with the case number and items to be tested.

Requests for items to be transported for entry in NIBIN are handled in conjunction with notification through SLCPD Crime Lab.

Requests for other analyses by State Crime Lab shall be completed by the assigned detective. The detective shall complete a request for analysis in UCJIS and send a copy of the barcode to the evidence unit for transport to the State Crime Lab.

803.3.2 UTAH PUBLIC HEALTH LABORATORY - FORENSIC TOXICOLOGY REQUESTS

Blood and/or urine requests for toxicology analysis by the Utah Public Health Laboratory - Forensic Toxicology shall be completed by the assigned detective. The detective shall complete a request for analysis in UCJIS and email the Toxicology Analysis Request Receipt to the evidence unit at evidence@slcgov.com for transport to the Utah State Health Lab. Evidence personnel attaches a PDF copy of the receipt to the property report and prints a hard copy of the receipt to attach it to the item request for analysis.

Salt Lake City Police Department

SLCPD Policy Manual

SLCPD Policy Manual

Property and Evidence Management

803.4 TRANSFER OF EVIDENCE TO CRIME LABORATORY

If the evidence is transported by an evidence technician, the transporting technician will check the evidence out of storage, indicating the date and time on the electronic property report and the request for laboratory analysis. If the evidence is transported by an officer, the evidence technician releasing the evidence must complete the required information in the electronic property report. In either case, the required lab forms will be transported with the evidence to the examining laboratory.

The original copy of the lab forms will remain with the evidence, and a copy of the forms will be returned to the Records Unit for filing with the case. If known samples have been collected by the case detective, the known samples will accompany the evidence being tested to the Crime Laboratory.

803.4.1 TRANSFER OF EVIDENCE TO STATE CRIME LAB

Prior to transport, a request for analysis shall be completed through UCJIS, and a transportation receipt printed. The items shall be presented to the intake clerk at the State Crime Lab with the transportation receipt. The intake clerk shall provide a receipt of acceptance. If the items were transported by evidence personnel, the receipt will be maintained by evidence with the transportation request until the item is returned to evidence custody.

State Crime Lab controlled substance analysis results are attached to the G.O. by evidence personnel. Requestors for the analysis will then be notified by evidence personnel of the results. The analysis results for NIBIN and/or serology are not required to be attached to the G.O. by evidence personnel.

803.4.2 TRANSFER OF EVIDENCE TO UTAH PUBLIC HEALTH LABORATORY - FORENSIC TOXICOLOGY

Upon delivery of the blood and/or urine, the officer or technician will record the personnel's name, date, and delivery time under the chain of custody section of the form. The form and items transported to Toxicology intake shall be given to the intake clerk. Utah Public Health Laboratory - Forensic Toxicology policy provides the option to wait for each item to be received and a receipt of acceptance provided or to log the items being delivered in the intake book, and the receipts of acceptance will be picked up by the evidence tech the next time a delivery is made. The receipts will be scanned and attached to the appropriate property report.

If the evidence returning is transported by an evidence technician, the transporting technician will match the Toxicology Return Form with the evidence received, update the evidence continuity indicating the transporter, date, and time the evidence was returned, along with notating for transportation only. The return form will be scanned and attached to the appropriate property report. Toxicology analysis results are sent to the SLCPD Records Unit. Records will ensure that upon completion of the laboratory testing, the written results are attached to the case file.

803.5 AUTHORITY TO RELEASE OR DISPOSE OF PROPERTY

Salt Lake City Police Department

SLCPD Policy Manual

SLCPD Policy Manual

Property and Evidence Management

803.5.1 EVIDENCE CONTINUITY

Each time an evidence technician receives property or releases property to another person, they shall enter the date, time and person receiving or returning the property into the property report evidence continuity for the case connected to the evidence. The evidence technicians shall obtain the signature of the person to whom the property is released and the reason for the release on an evidence release form or by electronic verification. Any employee receiving property shall be responsible for the property until it is properly returned to evidence or properly released to another authorized person or entity. Officers desiring property for court shall contact the evidence technicians at least one day prior to the court date and will provide a copy of their subpoena directing them to produce the evidence.

803.5.2 RELEASE AUTHORITY

Evidence technicians shall have the authority to release or dispose of property not connected to any criminal case and were received as found or booked for safekeeping, so long as the statutory requirements outlined in this policy are met. Items booked as found or for safekeeping that is restricted from release by department policy may be disposed of by the evidence technicians upon receipt. Property collected after a case involving a death shall require a supervisor or detective authorization prior to release or disposal, even for property booked as found, for safekeeping, or for disposal.

The release of seized property shall be made upon receipt of an authorized release form or email, listing the name of the person to whom the property is to be released. The release authorization shall be signed or sent by the authorizing supervisor or detective and must conform to the items listed in the property report or must specify the specific item(s) to be released. The authorization release form or email will be attached to the images of the property report by the evidence technician.

When a prosecuting attorney notifies the Department (i.e., the detective assigned to the case) that evidence may be returned to the rightful owner, an evidence technician shall attempt to notify the rightful owner that the property is available for return (Utah Code 24-3-103).

803.5.3 EVIDENCE DISPOSAL REVIEW

Evidence and Property Unit personnel shall not dispose of items held as evidence, without the authorization of the assigned detective or the authorization of the Prosecutor's Office. Evidence technicians shall reference the Evidence Disposal Memorandum from the Salt Lake County District Attorney's office dated May 1, 2018, and the Salt Lake City Prosecutor's office dated October 26, 2018 (hereafter referred to as the Prosecutor's Evidence Disposal Memorandum), for guidance and authorization for the disposal of cases held by the Property and Evidence unit. It shall be the case detective's responsibility to contact the evidence unit, in a timely manner if a criminally charged case has reached a resolution and the evidence can be disposed of.

When Evidence Room personnel identifies the property, which can be disposed of under the Prosecutor's Disposal Memorandum, for cases with an assigned detective, they will notify the assigned Detective via email that said property will be disposed of/released in 10 days. The

Salt Lake City Police Department

SLCPD Policy Manual

SLCPD Policy Manual

Property and Evidence Management

assigned detective and/or sergeant shall have 10 business days to respond. If the detective or sergeant requests additional time to respond or for the property to continue to be held, their request will be granted. If after 10 business days, an evidence technician has not received a response; they may release or dispose of the property as if they had received authority.

For detective approval, evidence personnel shall send an Evidence Review Request for Disposal Authorization to the assigned detective. If the assigned detective is no longer in the unit of assignment but employed by SLCPD, the unit sergeant shall be included in the Evidence review request. If the detective is no longer with the department, the review request will be sent to the sergeant alone. Airport and organized crime cases do not routinely have a detective assigned. These cases require a review request sent to the unit sergeant.

In the event that a case detective has not been assigned a criminally charged case, such as a misdemeanor case, it shall be incumbent upon the evidence technicians to follow the guidance of the Prosecutor's Evidence Disposal Memorandum as the authority to dispose of the evidence.

The following cases, whether there is an assigned detective or not, shall require authorization for disposal and do not fall within the 10 days for email response:

- Any cases involving a death
- Attempt suicide
- Agency assist
- Any case with a firearm
- Officer used a taser cartridge
- Any case referred to Internal Affairs
- Expungements

Such cases require direct authorization for disposal and shall not be considered implied consent.

In cases that are under four years old with no charges filed and/or no suspects, an evidence technician may petition for disposal by sending an email to the case detective requesting authority to dispose of or release the property. It shall be incumbent upon the case detective to review the status of the case and contact the prosecuting attorney, if applicable, to make this determination. Such cases require direct authorization from the detective or sergeant for disposal and shall not be considered for the 10-day implied consent rule outlined above.

At times, narcotics evidence will be booked into evidence that has been seized during an investigation involving a confidential informant. These cases will not be prosecuted, but used to further an investigation. Narcotics seized during this type of investigation shall be held for 90 days unless the Narcotics supervisor advises on retaining the evidence. Evidence technicians shall have the authority to dispose of these items of evidence.

Salt Lake City Police Department

SLCPD Policy Manual

SLCPD Policy Manual

Property and Evidence Management

Evidence technicians shall have the authority to dispose of evidence held for property-related crimes and drug-related crimes at least 10 years old that fall within one of the following criteria established by the Prosecutor's Evidence Disposal Memorandum:

- No charges filed
- A verdict has been reached on the case
- The case was dismissed

803.5.4 PRESERVATION OF SEXUAL ASSAULT DNA EVIDENCE

The Evidence Unit supervisor shall ensure that no biological evidence held by the Department is destroyed without adequate notification to the following persons, when applicable:

- (a) The appropriate prosecutor
- (b) Any sexual assault victim
- (c) The Investigations Division Commander

803.5.5 SEXUAL ASSAULT BIOLOGICAL EVIDENCE RETENTION

Some evidence, like blood and urine, associated with Sexual Assault Examination Kits require refrigeration. Refrigerators have been provided at both the Public Safety Building and the Evidence Warehouse. Sexual assault kits will be submitted to the Utah Bureau of Forensic Services as outlined in the Sexual Assault Investigations Policy. Any item of evidence gathered by this agency that may be subject to DNA testing and analysis in order to confirm the guilt or innocence of a criminal defendant and may not be disposed of before trial of a criminal defendant unless:

- (a) 50 years have passed from the date of evidence collection for sexual assault kits relating to an uncharged or unresolved crime; or
- (b) 20 years have passed from the date of evidence collection for restricted kits, and:
 1. The prosecution has determined that the defendant will not be tried for the criminal offense;
 2. The prosecution has filed a motion with the court to destroy the evidence; and
 3. An attempt has been made to notify the victim as required in Utah Code 77-37-3(3)(b)(i) and (ii).

If the evidence relates to an unsolved sexual offense, the victim shall be notified at least 60 days prior to destruction and provided with information on how to appeal the decision (Utah Code 77-37-3(3)).

803.5.6 BIOLOGICAL EVIDENCE NOT RELATED TO A SEXUAL ASSAULT

Biological evidence shall be retained for the time period set forth in the statute of limitations for the crime in which it was gathered for. Biological evidence related to a homicide or other crime not having a statute of limitation shall be retained indefinitely and may only be destroyed with the written approval of the Captain over Investigations and/or the head of the applicable prosecutor's office.

Salt Lake City Police Department

SLCPD Policy Manual

SLCPD Policy Manual

Property and Evidence Management

803.5.7 EXCEPTIONAL DISPOSITIONS

The following types of property shall be destroyed or disposed of in the manner, and at the time prescribed by law, unless a different disposition is ordered by a court of competent jurisdiction:

- (a) Weapons declared by law to be nuisances
- (b) Animals, birds, and related equipment that have been ordered forfeited by the court
- (c) Counterfeiting equipment
- (d) Gaming devices
- (e) Obscene matter ordered to be destroyed by the court
- (f) Altered vehicles or component parts
- (g) Narcotics (Utah Code 58-37-2 et seq.)
- (h) Unclaimed, stolen or embezzled property
- (i) Destructive devices

803.6 RELEASE OF PROPERTY

When a prosecuting attorney notifies the Department (i.e., the detective assigned to the case) that evidence may be returned to the rightful owner, an evidence technician shall attempt to notify the rightful owner that the property is available for return (Utah Code 24-3-103). For found property and property held for safekeeping shall be held for a minimum of 90 days. A notification letter shall be sent for the property where an owner and address are provided, notifying them of the 90 day hold. Prior to the release of the property, the owner shall provide:

- (a) Documentation establishing their identity and rightful ownership of the property.
- (b) Documentation that the owner may lawfully possess the property, if applicable.

The release of property from the Salt Lake City Police Department custody shall be documented on the Property Release Form or by signature capture. The release information shall indicate the case number, date of release, items being released, and to whom the items are being released to. The receiver shall sign the release form or signature capture. The release form will be attached to the images of the property report by the evidence technician. The signature capture utility will create a release copy which is automatically attached to the images of the property report. A copy of the receipt shall be provided to the owner if requested.

If the Department is unable to locate the rightful owner or the rightful owner is unable to lawfully possess the property, the Department may dispose of the property as provided by Utah Code 24-3-103.

If a court orders extraction and the return of personal digital data from a computer determined to be contraband, the Department shall determine the reasonable cost to provide the data, which shall be paid by the owner at the time the request is made (Utah Code 24-3-103).

All reasonable attempts shall be made to identify the rightful owner of found property or evidence not needed for an investigation. Confiscated alcohol, explosives, ammunition, narcotics, and

Salt Lake City Police Department

SLCPD Policy Manual

SLCPD Policy Manual

Property and Evidence Management

flammable items will not be returned to the owner. The release of property shall be made upon receipt of an authorized release form, listing the name and address of the person to whom the property is to be released. The release authorization shall be signed by the authorizing supervisor or detective and must conform to the items listed on the Property Form or must specify the specific item(s) to be released. An email will also suffice as a release authorization, so long as the evidence technician attaches the email to the case file.

803.6.1 DISPOSAL OF PROPERTY

Property that is taken to the evidence room and designated as found, booked for safekeeping, or personal property no longer needed for an investigation or court, shall be included in a public notice prior to disposal. Such property includes:

- (a) If the owner of any lost or mislaid property cannot be determined or notified, or if the owner of the property is determined and notified and fails to appear and claim the property after three months (90 days) of its receipt by the local law enforcement agency, the agency shall:
 1. Publish notice of the intent to dispose of the unclaimed property on Utah's Public Legal Notice Website established in Subsection 45-1-101(2)(b);
 2. Post a similar notice on Salt Lake City's website; and
 3. Post a similar notice in a public place designated for notice within the law enforcement agency.
- (b) The notice shall:
 1. Give a general description of the item, and the date of intended disposition.
 2. Evidence technicians may not dispose of unclaimed property until at least eight days after the date of publication and posting.
- (c) Property held in evidence may be released to the finder under the following conditions:
 1. No less than 90 days have expired from the date the property was turned into the Department and after the eight-day public notice.
 2. Evidence technicians shall contact the finder and advise them of their ability to petition for the property.
 3. The finder must petition the Chief of Police or designee and be able to provide the case number and the facts surrounding the finding of the property.
 4. If the Chief of Police or designee grants the request, the finder must sign a "Found Unclaimed Property Release Form": containing:
 - (a) An explanation as to how the property came into the finder's possession, including the time, date, and place.
 - (b) An affirmation that the finder does not know who the owner of the property is.
 - (c) A statement that the finder's possession of the property is lawful.

Salt Lake City Police Department

SLCPD Policy Manual

SLCPD Policy Manual

Property and Evidence Management

- (d) Such other information is known to the finder that may lead to an identification of the owner.
- (e) Other information the Department may request that will reasonably lead to discovering the true owner.
- (f) The true owner has not been determined from information provided by the finder or known to the City from other sources after reasonable efforts by the City have been made.
- (g) The intent to dispose of the property has been advertised by the procedure set forth in City Code.

No Department employee may claim or receive unclaimed property as a finder. Confiscated firearms, alcohol, explosives, ammunition, narcotics, electronic devices capable of holding personal information, and flammable items will not be returned to the finder. If that person has complied with the provisions of this policy, the person may take the lost or mislaid property if the person:

- (a) Pays the costs incurred for advertising and storage; and
- (b) Signs a receipt for the item.

803.6.2 DISPOSAL WITH NO CIVILIAN CLAIM

Property that is taken to the evidence room and designated as found or safekeeping property, or property no longer needed for investigation or court, shall be disposed of in the following manner :

- (a) Apply the property to a public interest use;
- (b) Sell the property at public auction and apply the proceeds of the sale to a public interest use; or
- (c) Destroy the property if it is unfit for public interest use or sale.

803.6.3 DISPOSITION BY APPROPRIATION

Divisions/Units may petition the Chief for an appropriation for use by the Department, unclaimed property as indicated in the above section:

- (a) A Division Commander must petition the Chief for approval of appropriation in writing.
- (b) The letter must describe the property, the intended use of the property, and the associated case number. The property must be used to benefit the Department.
- (c) If the appropriation is approved, a copy of the approval will be attached to the case. The property will be included in the annual report submitted to the Mayor's Office.
- (d) Property having a value of over \$500 will be added to the Department's inventory. All appropriated property will be included in the division's inventory.
- (e) Before applying the lost or mislaid property to a public interest use, the Police Department shall obtain from the city council:
 1. Permission to apply the property for public interest use; and

Salt Lake City Police Department

SLCPD Policy Manual

SLCPD Policy Manual

Property and Evidence Management

2. The designation and approval of the public interest use of the property.
3. An exception to this rule would be narcotics that are to be turned over to the Canine Unit.

803.7 RELEASE OF FIREARMS

The following are criteria guiding the release of firearms:

- (a) The owner of the property entered as safekeeping will be notified by a letter generated by Evidence Unit personnel.
- (b) The owner of the seized property will request the release of the weapon through the follow-up detective and/or the court.
- (c) When an owner calls for the release of a firearm, the evidence technicians should obtain the information to fill out the background check request form to be sent to the Utah State Bureau of Criminal Investigations (BCI). A BCI background check shall be completed prior to the release of any firearms, to verify that the owner is not a restricted person.
- (d) If there is no legal reason to retain the weapon, it will be returned to the owner.
- (e) If the person is found to be a restricted person, they will be directed to contact the Salt Lake City Attorney's Risk Management Office for questions involving the disposition of the firearm(s).
- (f) Firearms will not be released to third parties without either a court order or approval from the Chief of Police or the Chief's designee. This includes next-of-kin when the firearm was used/seized in a suicide or the legal owner is now deceased.
- (g) The weapon will be checked through NCIC prior to release.

Visitors retrieving firearms from the Evidence Unit will remain in the lobby and an evidence technician will bring the paperwork and the weapon to the lobby for release to the visitor. Under no circumstances will any ammunition be released with any firearm.

803.7.1 SAFE HARBOR ACT

Officers shall accept a firearm for safekeeping from any owner cohabitant who requests it, and who believes that another cohabitant is an immediate threat to him/herself, to the owner cohabitant, or any other person (Utah Code 53-5c-201).

The officer receiving the firearm shall:

- (a) Record the owner cohabitant's name, address, and telephone number.
- (b) Record the firearm's serial number.
- (c) Record the date that the firearm was accepted for safekeeping.
- (d) Obtain a signed declaration that the owner cohabitant has an ownership interest in the firearm. This declaration shall be given to the Records Unit to be scanned in and attached to the case. See attachment: Firearms Safe Harbor Declaration.pdf

Salt Lake City Police Department

SLCPD Policy Manual

SLCPD Policy Manual

Property and Evidence Management

The person committing the firearm shall not be asked or required to provide the name of or any other information about, the cohabitant who poses the threat. The Evidence Unit shall hold a firearm accepted pursuant to this policy for an initial period of 60 days, renewable for an additional 60 days upon request of the owner cohabitant. At the expiration of this time or upon request by the owner cohabitant, the firearm shall be returned to the owner cohabitant or another person authorized by law. If the person who committed the firearm for safekeeping cannot be located, the Department shall, after one year, dispose of the firearm in accordance with Utah Code 24-3-103.5 (Utah Code 53-5c-202).

If a firearm received under the Act is determined to be illegal to possess or to own, the officer shall confiscate and book the firearm according to current procedures, notify the person who requested that the firearm be taken for safekeeping of its confiscation, and dispose of the firearm in accordance with Utah Code 24-3-103.5 (Utah Code 53-5c-202). The Evidence Unit shall destroy any record created exclusively to document the safe keeping of the firearm within five days of releasing the firearm to the owner cohabitant or other authorized person, or of otherwise disposing of the firearm under the Utah Firearms Safe Harbor Act (Utah Code 53-5c-202).

803.8 OBTAINING COPIES OF PHOTOGRAPHS

With the exception of Crime Lab personnel, all photographs taken by on-duty police personnel of any crime, crime scene, or evidence will be attached directly to the case or sent to Records. Photographs taken by the Crime Lab will be filed in the Crime Lab's Digital Image Server and made available on Evidence.com.

803.8.1 REQUESTS FROM POLICE OFFICERS

Officers or prosecuting attorneys associated with the case can receive a compact disc with images with no charge for official use. Alternatively, a request can be made to have photos sent via email link through Evidence.com.

Homicide photographs, serious injury photos, assault photos, sexual assault photos or other photographs deemed sensitive in nature by the Crime Lab Supervisor will not be provided except to the detective assigned the follow-up investigation of the case or by permission of the sergeant supervising the respective follow-up investigative unit or other appropriate command authority. Subject to the above-mentioned conditions, a copy of the images may be burnt to compact disc and retained in the Crime Lab until the requesting officer picks them up. Alternatively, a request can be made to have photos sent via email link through Evidence.com.

803.8.2 REQUESTS FROM OFFICIAL GOVERNMENT AGENCIES

Compact discs of photo images may be burnt without charge for government agencies when the images are to be used in criminal cases, civil cases, regulatory hearings, etc. In each case, the images will be provided for official business only. Alternatively, a request can be made to have photos sent via email link through Evidence.com. Requests for compact discs of the images must be made in writing and given directly to the Records Unit or the Government Records Access and Management Act (GRAMA) Coordinator.

Salt Lake City Police Department

SLCPD Policy Manual

SLCPD Policy Manual

Property and Evidence Management

The Investigations Division Commander or designee will redact the photos deemed sensitive in nature and exclude them from being released (see the Records Management and Release Policy). After the review, the images will be forwarded to the GRAMA Coordinator who will then notify the requesting agency that the compact discs are available to be picked up at the Records Unit service window on the first floor of the PSB.

803.8.3 REQUESTS FROM NON-GOVERNMENTAL AGENCIES

Requests for copies of images from non-governmental agencies like civil attorneys, private parties, and responses to subpoenas or court orders, shall be made in writing and given directly to the Government Records Access and Management Act (GRAMA) Coordinator or designee.

If the request involves a homicide, death, suicide, sex crime, domestic violence, fatal accident, an officer-involved shooting, the case is gang-related, or is considered to be high profile; the GRAMA Coordinator will forward the request to the appropriate Division Commander.

If criminal action is pending, the request will be denied, except in response to a subpoena or court order. If no criminal action is pending, the request will be forwarded to the follow-up detective's Division Commander or designee who will be responsible for determining which of the digital images are appropriate for release.

The GRAMA Coordinator will advise the requestor of the fee for the compact disc containing digital images and once payment has been received, the request will be completed.

803.9 EMERGENCY RELEASE PROCEDURE

Property and evidence is normally released during the hours of 10:00 a.m. to 2:00 p.m., Monday, Wednesday, and Friday. The Evidence Unit is closed at 4:00 during the week and on weekends and holidays. Property may be released after hours on an emergency basis. In such cases, an officer of the rank of Lieutenant or above must authorize the callback of a minimum of 2 evidence technicians. The final disposition of all such property shall be fully documented in related reports.

803.10 DISPUTED CLAIMS TO PROPERTY

Occasionally more than one party may claim an interest in the property being held by the Department, and the legal rights of the parties cannot be clearly established. Such property shall not be released until one party has obtained a valid court order or some other undisputed right to the involved property.

All parties should be advised that their claims are civil. In extreme situations, legal counsel for the Department may wish to file an interpleader to resolve the disputed claim.

803.11 SECURITY OF CONTROLLED SUBSTANCES AND WEAPONS FOR TRAINING

All narcotics, firearms, and explosives shall be housed in a separate area from the rest of general evidence. The narcotics and firearms shall be secured with a locking door that only evidence technicians can access.

All of the above-listed items will be audited semi-annually by the Evidence Unit supervisor.

Salt Lake City Police Department

SLCPD Policy Manual

SLCPD Policy Manual

Property and Evidence Management

803.12 INSPECTIONS OF THE EVIDENCE ROOM

In order to maintain a high degree of evidentiary integrity over agency controlled property and evidence, the following documented inspections, inventory, and audits shall be completed:

- (a) An inspection to determine adherence to procedures used for the control of property and evidence is conducted semi-annually by the person responsible for the property and evidence control function or his/her designee.
- (b) An audit of property and evidence in compliance with Appendix I of the CALEA standards manual occurs whenever the property and evidence custodian is assigned to and/or transferred from the position and is conducted jointly by the newly designated property and evidence custodian and a designee of the Chief of Police to ensure that records are correct and properly annotated.
- (c) An annual audit of property and evidence in compliance with Appendix K of the CALEA standards manual is conducted by a person not routinely or directly connected with control of property and evidence as directed by the Chief of Police.
- (d) Unannounced inspections of property and evidence storage areas are conducted, as directed by the Chief of Police, at least once a year.

803.13 ADMITTANCE TO THE EVIDENCE WAREHOUSE

Admittance to the Evidence Warehouse should be restricted to the evidence technician(s), and the evidence supervisor. All other individuals entering the Evidence Warehouse will require an escort and an Evidence Warehouse access log entry shall be made indicating:

- (a) Date and time of entry and exit.
- (b) Name of individual(s) entering the Evidence Warehouse.
- (c) Reason for entry.
- (d) Name of the escort.

803.14 AFTER HOURS ALARMS AT THE EVIDENCE WAREHOUSE

Whenever dispatch is notified that an alarm has been triggered inside the Evidence Warehouse, the Crime Lab/Evidence Director or Evidence Unit supervisor shall be notified and he/she will send two evidence technicians (this is designated by a rotating roster) to respond to facilitate access to the secured portion of the Evidence Warehouse. The responding officers shall secure the area and evidence technicians will notate the officers' presence in the secured area on the log. At no time will less than two officers search the Evidence Warehouse. Both officers will complete a report documenting their actions.

803.15 REVISIONS

Enacted: April 23, 2018

Revised: September 28, 2022

Digital Evidence

804.1 PURPOSE AND SCOPE

Computers and other digital media devices can be used to facilitate the commission of crimes, can contain evidence of crimes, and can be the target of criminal intrusion. This policy provides members general guidance on the collection of digital evidence. For specific collection procedures of digital evidence (i.e., computer systems, recording devices, recording media) refer to the Digital Evidence Handling Procedure.

804.2 POLICY

Computer systems, digital media devices, and associated electronic data are commonly encountered in the investigation of sexual exploitation of children, identity theft, forgery, and other crimes. Officers having the need to seize this type of equipment should follow the guidelines contained in the Digital Evidence Handling Procedure.

Unusually complex systems, or those which appear to be actively connected to a large network, may require the assistance of specially trained officers/personnel. To help determine if a computer is connected to a network check for the presence of several computers, which are physically connected to one another, or located in an office environment. Officers should be aware that networks can be established wirelessly through wireless routers or cards connected to the computer/device. In most cases, witnesses, suspects, or others familiar with the system can state whether or not the device being seized is part of a network.

Disconnecting a device which is part of a small, private network, such as that which links computers/devices in a private home, will generally not cause damage; however, those located in a business environment or home office environment should be approached with caution. If in doubt as to whether or not damage will be caused to a possible network, officers should consult with an officer or crime lab technician that has been specially trained in computer forensics.

804.3 REVISIONS

Enacted: April 23, 2018

Records

805.1 PURPOSE AND SCOPE

The Records Director may maintain a Records Unit Procedure Manual to reflect the procedures being followed within the Records Unit. Policies that apply to all employees of the Department are contained in this chapter.

805.1.1 NUMERICAL FILING SYSTEM

Case reports are generated numerically. Reports are numbered commencing with the last two digits of the current year followed by a sequential number beginning with 1 starting at midnight on the first day of January of each year. As an example, case number 17-1 would be the first new case beginning January 1, 2017.

805.2 RECORDS DIRECTOR RESPONSIBILITIES

The Chief of Police shall designate a Records Director. The responsibilities of the Records Director include, but are not limited to:

- (a) Managing the records management system (RMS) for the Department, including the retention, archiving, and destruction of department public records; and, in concert with the GRAMA Coordinator, the release of department public records.
 - i. This includes performing the duties specified for governmental entities under the Public Records Management Act (Utah Code 63G-2-307).
 - ii. This includes the maintenance and destruction of imaging surveillance data as required by Utah Code 77-23d-105.
- (b) Maintaining and updating the department records retention schedule including:
 - i. Identifying the minimum length of time the Department must keep records.
 - ii. Identifying the division responsible for the original record.
- (c) Establishing rules regarding the inspection and copying of department public records as reasonably necessary for the protection of such records.

805.3 RECORDS TO BE MAINTAINED

The Salt Lake City Police Department maintains all official reports and records. None of the records are purged, except upon court order, or as outlined in the Criminal Organizations Policy.

CAD calls are purged from the CAD system after one year. If there is a case attached to a CAD call, the call will be placed in the RMS file and kept in accordance with the established retention schedule.

805.4 FILE ACCESS AND SECURITY

All reports including, but not limited to, initial, supplemental, follow-up, evidence, and other reports critical to a case shall be maintained in the Records Management System (RMS) on a secure system. The RMS allows Department-wide viewing of most case files. However, with the approval

Salt Lake City Police Department

SLCPD Policy Manual

SLCPD Policy Manual

Records

of a supervisor, general access to reports may be restricted. The Records Unit is staffed 24 hours a day, 7 days a week, allowing access to Records personnel after normal business hours.

Salt Lake City Police Department employees shall not access, view or distribute, or allow anyone else to access, view or distribute any record, file or report, whether hard copy or electronic file format, except in accordance with department policy and with a legitimate law enforcement or business purpose or as otherwise permissible by law.

805.4.1 JUVENILE RECORDS

Juvenile records will be distinguished by the RMS when entering the age of the juvenile into the system. The RMS automatically makes a note dictating that the record is of a juvenile when the age is determined to be under 18.

All photographs and other forms of identification legally collected from juveniles will be stored in the RMS file and secured as all other files but marked as juvenile records. Fingerprints of juveniles are not retained by this Department, instead they are submitted to BCI who maintains them. All juvenile records kept by this Department will be housed in the secure system, or if it is a physical copy will be kept in a secured area.

Pursuant to state law, there is no requirement for the Records Unit to purge juvenile records after reaching adult age. All persons labeled as a juvenile in any police report or record shall have those reports or records maintained in their current state when they reach adult age, barring expungement when ordered by a court.

Dissemination of any juvenile records by this department will only be done in accordance with applicable state laws.

This department shall follow all court ordered expungement of juvenile records immediately. See the Records Unit Procedure for instructions on expungements.

805.4.2 TRAFFIC CITATION MAINTENANCE

Officers are encouraged to utilize the e-citation program/device when issuing citations. If this is not possible, paper citations will be allowed. E-citation software when possible will be loaded onto department field electronics for department members' use. E-citations issued will be submitted to records through the department's secure record management system.

Officers may respond to the Quartermaster for a paper citation book. Upon issuing a citation book, Quartermaster personnel shall document to whom they are issuing the book and what the citation numbers are. All citation books are to be securely stored in the Quartermaster's office, which is restricted to authorized personnel.

Officers shall be responsible for properly securing any issued citation books in their possession.

If paper citations are issued, they will be submitted to Records to be scanned and sent to the appropriate court.

Salt Lake City Police Department

SLCPD Policy Manual

SLCPD Policy Manual

Records

805.5 REVISIONS

Enacted: April 23, 2018

Revised: April 4, 2023

Records Maintenance and Release

806.1 PURPOSE AND SCOPE

This policy provides guidance on the maintenance and release of department records. Protected information is separately covered in the Protected Information Policy.

806.2 POLICY

The Salt Lake City Police Department is committed to providing public access to records in a manner that is consistent with the Utah Government Records Access and Management Act (GRAMA) (Utah Code 63G-2-101 et seq.).

806.3 GRAMA COORDINATOR RESPONSIBILITIES

The Chief of Police shall designate a GRAMA Coordinator. The responsibilities of the GRAMA Coordinator include, but are not limited to:

- (a) Identifying records or portions of records that are confidential under state or federal law and not open for inspection or copying.
 - (a) The GRAMA Coordinator shall be responsible for filing a statement with the state archivist explaining the reasons a record series that is designated as private or controlled under GRAMA is being collected or used by the Department (Utah Code 63G-2-601).
- (b) Establishing rules regarding the processing of subpoenas for the production of records.
- (c) Ensuring a current schedule of fees for public records as allowed by law is available (Utah Code 63G-2-203).
- (d) Forwarding requests to the appropriate agency when a requester seeks records that are not in the possession of the Department (Utah Code 63G-2-204).

806.4 PROCESSING REQUESTS FOR PUBLIC RECORDS

Any department member who receives a request for any record shall route the request to the GRAMA Coordinator or the authorized designee.

806.4.1 REQUESTS FOR RECORDS

The processing of requests for any record is subject to the following:

- (a) The Department is not required to create records that do not exist.
- (b) When a record contains material with release restrictions and material that is not subject to release restrictions, the restricted material shall be redacted and the unrestricted material released.
 - (a) A copy of the redacted release should be maintained in the case file for proof of what was actually released and as a place to document the reasons for the redactions. If the record is audio/video, a copy of the redacted audio/video release should be maintained in the department-approved media storage

Salt Lake City Police Department

SLCPD Policy Manual

SLCPD Policy Manual

Records Maintenance and Release

system and a notation should be made in the case file to document the release and the reasons for the redacted portions.

- (c) Requests for records must be in writing and contain the requester's name, contact information, and a description of the record requested (Utah Code 63G-2-204).
- (d) The GRAMA Coordinator or designees shall review each request for records within 10 business days unless the person has requested an expedited response. Expedited requests must be reviewed within five business days (Utah Code 63G-2-204).
- (e) Unless the GRAMA Coordinator or designees are prohibited by law from releasing the requested record; extraordinary circumstances exist, as defined in Utah Code 63G-2-204; or the request is submitted by or on behalf of a person confined in a jail or other correctional facility, the record shall be released.
 - (a) If the existence of extraordinary circumstances precludes approval or denial of the request within the time permitted under law, additional time may be granted.
 - (b) Requests made by or on behalf of a person in jail or another correctional facility for a record that contains a specific reference to the individual so confined may be released up to five times per calendar year. This restriction does not apply to requests submitted by an attorney of an individual (Utah Code 63G-2-201).
- (f) If the GRAMA Coordinator or designees deny a request, a notice of denial shall be sent to the requester. The notice shall contain a description of the record denied, the legal basis upon which the denial was based, and information related to the appeal process available to the requester (Utah Code 63G-2-205).

806.4.2 APPEALS

The denial of a request for records by the GRAMA Coordinator or designees may be appealed to the Mayor's Records Appeals Board by filing a written notice with the City Recorder within 30 calendar days of the denial. If the Appeals Board affirms the denial, notice shall be sent to the requester informing him/her of the right to appeal the denial to the records committee, district court (or local appeals board, if established), the time limits for filing such appeal, and the contact information of the executive secretary of the records committee (or local appeals board, if established) (Utah Code 63G-2-401).

806.5 RELEASE RESTRICTIONS

Examples of release restrictions include, but are not limited to:

- (a) Personal identifying information, including an individual's photograph; Social Security and driver identification numbers; name, address, and telephone number; and medical or disability information that is contained in any driver's license record, motor vehicle record, or any department record, including traffic accident reports, are restricted except as authorized by the Department, and only when such use or disclosure is permitted or required by law to carry out a legitimate law enforcement purpose (18 USC § 2721; 18 USC § 2722; Utah Code 53-3-109; Utah Code 41-6a-404).
- (b) Victim information may be protected by statutes (Utah Code 77-37-4).
- (c) Personnel records (Utah Code 63G-2-302; Utah Code 63G-2-303).

Salt Lake City Police Department

SLCPD Policy Manual

SLCPD Policy Manual

Records Maintenance and Release

1. Specific personnel information related to undercover officers or investigative personnel is exempt from disclosure if release could reasonably impair the effectiveness of investigations or endanger any individual's safety (Utah Code 63G-2-301).
- (d) Properly classified records that contain medical, psychiatric, or psychological data about a person if released would be detrimental to the person's mental health or safety or would violate normal professional practice and medical ethics (Utah Code 63G-2-304).
- (e) Records were created exclusively in anticipation of potential litigation involving this department (Utah Code 63G-2-305).
- (f) Automated license plate reader (ALPR) data (Utah Code 41-6a-2004).
- (g) Imaging surveillance data (Utah Code 77-23d-105).
- (h) Certain types of reports involve but are not limited to, child abuse and neglect (Utah Code 80-2-1005).
- (i) Certain audio and video recordings created by a body-worn camera that recorded sound or images:
 1. Inside a home or residence (Utah Code 63G-2-302; Utah Code 77-7a-107).
 2. Inside a hospital or health care facility, inside a clinic of a health care provider, or inside a human service program (Utah Code 63G-2-305).
- (j) Certain data was collected by an unmanned aircraft system (Utah Code 72-14-204).
- (k) Any other information that may be appropriately denied by:
 1. Utah Code 63G-2-302 (private records).
 2. Utah Code 63G-2-303 (private information of government employees).
 3. Utah Code 63G-2-304 (controlled records).
 4. Utah Code 63G-2-305 (protected records).

806.6 SUBPOENAS AND DISCOVERY REQUESTS

Any member who receives a subpoena duces tecum or discovery request for records should promptly contact a supervisor and the GRAMA Coordinator for review and processing. While a subpoena duces tecum may ultimately be subject to compliance, it is not an order from the court that will automatically require the release of the requested information.

Generally, discovery requests and subpoenas from criminal defendants and their authorized representatives (including attorneys) should be referred to the District Attorney, City Attorney or the courts.

All questions regarding compliance with any subpoena duces tecum or discovery request should be promptly referred to legal counsel for the Department so that a timely response can be prepared.

Salt Lake City Police Department

SLCPD Policy Manual

SLCPD Policy Manual

Records Maintenance and Release

806.7 RELEASED RECORDS TO BE MARKED

All released records will have documentation regarding who approved the release and what was released.

806.8 EXPUNGEMENT

Expungement orders received by the Department shall be reviewed for appropriate action by the Records Unit. Records personnel shall expunge such records as ordered by the court. Records may include but are not limited to, a record of arrest, investigation, detention, or conviction. Refer to the Records Unit Procedure for the process of expungement.

Upon receiving an order for vacatur, Records personnel shall comply with the provisions of Utah Code 77-40a-402.

806.9 TRAINING

The GRAMA Coordinator shall, on an annual basis, successfully complete an online records management training course provided by the Utah Department of Administrative Services' Division of Archives and Records Service (Utah Code 63G-2-108).

806.10 REVISIONS

Enacted: April 23, 2018

Protected Information

807.1 PURPOSE AND SCOPE

The purpose of this policy is to provide guidelines for the access, transmission, release and security of protected information by members of the Salt Lake City Police Department. This policy addresses the protected information that is used in the day-to-day operation of the Department and not the public records information covered in the Records Maintenance and Release Policy.

807.1.1 DEFINITIONS

Definitions related to this policy include:

Protected information - Any information or data that is collected, stored or accessed by members of the Salt Lake City Police Department and is subject to any access or release restrictions imposed by law, regulation, order or use agreement. This includes all information contained in federal, state or local law enforcement databases that is not accessible to the public.

807.2 POLICY

Members of the Salt Lake City Police Department will adhere to all applicable laws, orders, regulations, use agreements and training related to the access, use, dissemination and release of protected information.

807.3 RESPONSIBILITIES

The Chief of Police shall select a member of the Records Unit as the Department's Terminal Agency Coordinator (TAC).

The responsibilities of the TAC include, but are not limited to:

- (a) Ensuring member compliance with this policy and with requirements applicable to protected information, including requirements for, but not limited to, the Utah Criminal Justice Information System (UCJIS), National Crime Information Center (NCIC) system, National Law Enforcement Telecommunications System (NLETS), Department of Motor Vehicle (DMV) records, etc.
- (b) Developing, disseminating and maintaining procedures that adopt or comply with the U.S. Department of Justice's current Criminal Justice Information Services (CJIS) Security Policy.
- (c) Developing, disseminating and maintaining any other procedures necessary to comply with any other requirements for the access, use, dissemination, release and security of protected information.
- (d) Developing procedures to ensure training and certification requirements are met.
- (e) Resolving specific questions that arise regarding authorized recipients of protected information.
- (f) Ensuring security practices and procedures are in place to comply with requirements applicable to protected information.

Salt Lake City Police Department

SLCPD Policy Manual

SLCPD Policy Manual

Protected Information

807.4 ACCESS TO PROTECTED INFORMATION

Protected information shall not be accessed in violation of any law, order, regulation, user agreement, Salt Lake City Police Department policy or training. Only those members who have completed applicable training and met any applicable requirements, such as fingerprinting and a background check, may access protected information, and only when the member has a legitimate criminal justice purpose for such access.

Unauthorized access, including access for other than a legitimate work-related purpose, is prohibited and may subject a member to administrative action pursuant to the Complaints Against Personnel and Disciplinary Action Policy and/or criminal prosecution.

807.4.1 PENALTIES FOR MISUSE OF RECORDS

Misuse of access to criminal history record information is a class B misdemeanor (Utah Code 53-10-108(12)(a)).

When any member discovers or becomes aware of any unauthorized use of records created or maintained by the Utah Bureau of Criminal Identification (BCI), that member shall notify their immediate supervisor who shall handle the complaint in accordance with the Complaints Against Personnel and Disciplinary Action Policy. The Chief of Police or their designee must inform the Commissioner and the Director of BCI of any unauthorized use of records created or maintained by BCI (Utah Code 53-10-108(12)(b)).

807.4.2 ACCESS TO RECORDS UNIT

The Records Unit is a restricted area. Only authorized department personnel have key card access. The on-duty Records Unit supervisor will monitor all persons entering the restricted area and challenge anyone who is not authorized to be in that location.

807.4.3 UCJIS LEVEL OF ACCESS AND REQUIREMENTS

All UCJIS Users, Non-Users, and Non-Access Users must comply with CJIS security measures. The different levels of UCJIS access and requirements for each access level are listed below. Records staff will provide the appropriate forms.

- I. **USER:** Anyone who has direct access to UCJIS (current login).
 1. Must sign a "UCJIS User Security Agreement".
 2. Be fingerprinted (ID required) – Must be retained in the FBI's Rap Back system.
 3. Initial name-based background check.
 4. Training and testing every 2 years.
- II. **NON-ACCESS USER:** Anyone who obtains UCJIS records from a person who has direct access (this is anyone who looks at hard copies of UCJIS records or discusses items from UCJIS, as well as users of the department's RMS).
 1. Must sign a "UCJIS User Security Agreement" (a NON-ACCESS USER is considered a USER).
 2. Be fingerprinted (ID required) – Must be retained in the FBI's Rap Back system.

Salt Lake City Police Department

SLCPD Policy Manual

SLCPD Policy Manual

Protected Information

3. Initial name-based background check.
 4. Training and testing every 2 years.
- III. NON-USER: A person who does not have a UCJIS login but has indirect access. Indirect access is defined as unescorted access to areas where protected information may be available either on a computer monitor, printed material, or overheard in verbal discussions (this is anyone unescorted in secure areas of a police department facility such as IT personnel, custodians, volunteers, contractors, etc., who are not accessing the department's RMS).
1. Must sign a "UCJIS Non-User Security Agreement".
 2. Be fingerprinted (ID required) – Must be retained in the FBI's Rap Back system.
 3. Initial name-based background check for IT users and other non-users.
 4. Obtain required training for non-users as outlined in current CJIS policy.

807.5 RELEASE OR DISSEMINATION OF PROTECTED INFORMATION

Protected information may be released only to authorized recipients who have both a right to know and a need to know (Utah Code 53-10-108).

A member who is asked to release protected information that should not be released should refer the requesting person to a supervisor or to the Records Director for information regarding a formal request.

Unless otherwise ordered or when an investigation would be jeopardized, protected information maintained by the Department may generally be shared with authorized persons from other law enforcement agencies who are assisting in the investigation or conducting a related investigation.

807.6 SECURITY OF PROTECTED INFORMATION

The TAC will be responsible for overseeing the security of protected information.

Responsibilities include, but are not limited to:

- (a) Developing and maintaining security practices, procedures and training.
- (b) Ensuring federal and state compliance with the CJIS Security Policy and the requirements of any state or local criminal history records systems. These requirements include, but are not limited to:
 - i. Before granting access, the department's information system shall display an approved system use notification message informing potential users of various usage and monitoring rules.
 - ii. UCJIS users who access UCJIS information through a mobile device must have Mobile Device Management (MDM) installed on that device.
- (c) Tracking, documenting and reporting all breach of security incidents to the Chief of Police and appropriate authorities.

Salt Lake City Police Department

SLCPD Policy Manual

SLCPD Policy Manual

Protected Information

807.6.1 MEMBER RESPONSIBILITIES

Members accessing or receiving protected information shall ensure the information is not accessed or received by persons who are not authorized to access or receive it. This includes leaving protected information, such as documents or computer databases, accessible to others when it is reasonably foreseeable that unauthorized access may occur (e.g., on an unattended table or desk; in or on an unattended vehicle; in an unlocked desk drawer or file cabinet; on an unattended computer terminal).

All protected information that is printed shall be immediately destroyed after use by shredding or other effective means.

807.6.2 STORAGE OF INFORMATION

Members are prohibited from storing protected information on portable electronic media devices (USB flash drives, CD-R, memory cards, external drive devices, etc.).

Members are prohibited from storing protected information on personally owned electronic devices and/or personally owned information systems.

Members who access protected information through Citrix or Outlook Web Access shall not save attachments or data in any form to a personally owned computer or other device.

807.6.3 TRANSFER OF INFORMATION

The following will be followed during transfer of protected information in a physical media (printed documents, printed imagery, etc.) and/or a digital media format:

- (a) When removed from a controlled area (i.e., restricted area of the Department), the media is always within possession of an authorized employee.
- (b) The media will only be delivered to, and left with, individuals or agencies who are authorized to be in possession of it.
- (c) If the media is delivered to an authorized agency and is not being left directly with an authorized individual, it will only be left in a controlled area of that agency's location which has been designated for such.

807.7 REVISIONS

Enacted: April 23, 2018

Chapter 9 - Custody

Temporary Custody

900.1 PURPOSE AND SCOPE

This policy provides guidelines to address the health and safety of individuals taken into temporary custody by members of the Salt Lake City Police Department.

Additional regulations regarding specific issues with the temporary custody of juveniles are addressed in the Temporary Custody of Juveniles Policy.

Custodial searches are addressed in the Custodial Searches Policy.

900.2 POLICY

Police Officers may place subjects into custody for various reasons such as arrest, investigations, etc. Officers are responsible for the reasonable safety of those in their custody and will not place them in unreasonable danger or in an unsupervised restricted area. Officers may transport subjects in custody to various places such as a DUI processing area, interview room, witness line-up, jail, etc. Some facilities have rooms or areas to secure the person in custody while the officer completes related tasks. Officers will ensure that subjects placed in those areas are constantly monitored for the safety of:

- The subject
- Other citizens
- Employees

900.3 GENERAL SUPERVISION

Officers will ensure that any subject in their custody will be supervised and no subject will be left restrained or in a restricted area without supervision. Officers shall document important events such as when and where the subject was:

- Placed in custody
- Transported
- Placed under another officer's supervision
- Released or other disposition
- The reason for temporary custody

Officers shall also document the date and time a detainee is taken in and out of a Department facility, as well as any meals provided during the detention.

900.4 UTILIZATION OF INTERVIEW AND DUI EXAM ROOMS

The Salt Lake City Police Department maintains rooms at the Public Safety Building, Airport Operations Center, and Pioneer Precinct designated for conducting interviews, interrogations, polygraph examinations, voice stress analysis and DUI/DRE exams. The following procedures

Salt Lake City Police Department

SLCPD Policy Manual

SLCPD Policy Manual

Temporary Custody

shall apply to any public safety employee who utilizes the interview or exam rooms at all Department facilities:

- (a) Only authorized personnel are allowed into interview/exam rooms.
 - i. If a detainee is in the interview room, only persons involved with the detainee, or approved by the case agent, shall be allowed in the room.
- (b) Only the number of personnel required in the room will be allowed.
- (c) The transporting officer is responsible for the safety and security of persons brought to the interview/exam rooms, unless relieved by another officer or detective, who will formally assume responsibility for the individual.
- (d) All detainees should be thoroughly searched for weapons and/or contraband prior to being placed in an interview/exam room.
- (e) All detainees will be walked through a metal detector prior to being placed in an interview room.
- (f) Officers should use discretion and abide by applicable laws to conduct protective frisks of persons not in custody.
- (g) Officers should thoroughly check the interview/exam room for the presence of weapons and/or contraband as well as prior damage to the room(s) prior to placing someone in an interview/exam room and again immediately after their removal from the room.
- (h) If utilizing an interview or exam room equipped with audio/video recording, officers shall turn on the audio/video recording for the selected room.
- (i) Officers or outside law enforcement guests may wear firearms in an interview room if the firearm is secured in an approved holster. If an officer elects to wear a firearm during an interview/interrogation with a detainee, there must be two officers present during the interview.
 - i. If an officer leaves the interview room, the second officer should also exit and wait in the hall until both officers re-enter the interview room together.
 - ii. Two officers are not required in a DUI/DRE exam room, or an interview room with a witness/victim, if an officer chooses to wear a firearm, which is left to their discretion.
- (j) If an officer elects to not wear a firearm while in the interview room, the firearm must be secured in a safe location or in the lockers provided outside of the interview room area. Officers will not store firearms in their desks.
- (k) Handcuffs may be removed at the discretion of the officer(s) conducting the interview. If there is any doubt as to an officer's safety, the individual will remain handcuffed during the interview.
- (l) If a person in custody is left alone in an interview room or exam room, visual contact will be maintained via video or sight.
- (m) A person in custody for investigation of DUI may be handcuffed to the fixed bench in the DUI/DRE exam room so long as there is constant visual monitoring of the subject.

Salt Lake City Police Department

SLCPD Policy Manual

SLCPD Policy Manual

Temporary Custody

- (n) The officer(s) responsible for a detainee shall have face-to-face visual observation of secured detainees at least every 15 minutes.
- (o) Witnesses, victims, or persons not in custody should not be left in interview rooms for extended periods of time. Officers should make visual contact at least once every 15 minutes.
- (p) Officers will ensure that basic needs of persons in the interview and exam rooms are met, including access to restrooms and water.
- (q) Persons in temporary custody will have sight and sound separation from other detainees of the opposite sex unless the persons are under constant monitoring.
- (r) Sight and sound separation shall be maintained between all juvenile detainees and adult detainees while in custody at the Salt Lake City Police Department (42 USC § 5633; Utah Code 62A-7-201(3)). In situations where brief or accidental contact may occur, a member of the Salt Lake City Police Department shall maintain a constant, immediate presence with the juvenile or the adult to minimize any contact. If inadvertent or accidental contact does occur, reasonable efforts shall be taken to end the contact.
- (s) In the event of an emergency in the Public Safety Building interview rooms, officers may utilize the red panic/duress alarm button that is on the wall. This alarm will provide a visual and auditory alarm for other members that are in the building.
- (t) If a fire alarm is activated, or evacuation of the facility is needed for any other reason, the officer(s) monitoring an individual is responsible for evacuating the individual in accordance with the facility's evacuation plan.
- (u) Chairs, a table, and any other equipment that is necessary to perform required duties, and that does not unreasonably compromise safety, may be kept in the interview rooms and DUI/DRE exam rooms. A gurney should be kept in, or next to, the DUI/DRE exam rooms.

900.4.1 INSPECTION AND REVIEW

An inspection and administrative review of all interview/exam rooms, along with procedures regarding such, shall be conducted annually.

900.5 ESCAPE PREVENTION

In the event a person in temporary custody attempts to escape or does escape, the following will be adhered to:

- If the person in custody is able to escape the interview room and is in the building, the officer shall notify dispatch immediately.
 - A detailed description of the person will be provided to dispatch, and dispatch will broadcast an ATL for the subject.
 - An announcement will be made over the buildings public address (PA) system informing the employees inside of the escape and description of the subject.
 - A thorough search of the entire building, in person and with the utilization of cameras, will commence by officers until the person is located.

Salt Lake City Police Department

SLCPD Policy Manual

SLCPD Policy Manual

Temporary Custody

- If the person is able to exit the building, the responsible officer shall immediately notify dispatch.
 - A detailed description of the subject will be given to dispatch and dispatch will broadcast an ATL for the subject.
 - All available officers will be dispatched to the area to perform a search for the person.

900.6 DETAINEES REQUIRING MEDICAL ATTENTION

Detainees requiring medical care should not be transported to the jail or a police facility until the medical condition has been treated.

900.6.1 DETAINEES TREATED AND RELEASED

If the detainee is transported to the hospital for treatment and the detainee is not admitted, the officer will retain custody until the treatment is concluded and the detainee is booked into the jail or transported to a police facility if required. When encountering an excessive wait for treatment or a lengthy treatment process, officers may elect to issue a misdemeanor citation if applicable, or delay the arrest procedure with the concurrence of their supervisor.

900.6.2 DETAINEES ADMITTED TO THE HOSPITAL

For applicable misdemeanor offenses, an arrested person who is transported to the hospital and admitted should be released on a misdemeanor citation. The person may be left at the hospital without guard if the person is non-combative.

For felony offenses where the detainee is admitted to the hospital, the officer shall notify their immediate supervisor. At the discretion of the Watch Commander, the detainee may remain under guard until released from the hospital. When directed, the arresting officer will initiate the guard duty procedure. Refer to the Hospital Guard Duty Procedure for further detail.

900.7 TRAINING

Department members should be trained and familiar with this policy and any supplemental procedures. This shall include initial training on how to properly use rooms designated for temporary custody, and continuing training at least once every four years.

900.8 REVISIONS

Enacted: April 23, 2018

Revised: May 21, 2018

Revised: November 6, 2019

Custodial Searches

901.1 PURPOSE AND SCOPE

This policy provides guidance regarding searches of individuals in custody. While this policy applies to both adults and juveniles in custody, officers shall adhere to the additional juvenile requirements (e.g., parental notification, secure custody, etc.) outlined in the Temporary Custody of Juveniles Policy.

Nothing in this policy is intended to prohibit the otherwise lawful collection of evidence from an individual in custody.

901.1.1 DEFINITIONS

Definitions related to this policy include:

Custody search - An in-custody search of an individual and of his/her property, shoes and clothing, including pockets, cuffs and folds on the clothing, to remove all weapons, dangerous items and contraband.

Physical body cavity search - A search that includes a visual inspection and may include a physical intrusion into a body cavity. Body cavity means the stomach, rectal cavity, or vagina.

Strip search - A search that requires an individual to remove some or all of his/her clothing to permit a visual inspection of the breasts, buttocks, anus or outer genitalia. This includes monitoring an individual who is changing clothes, where his/her buttocks, genitalia or female breasts are visible.

901.2 POLICY

All searches shall be conducted with concern for safety, dignity, courtesy, respect for privacy, and in compliance with policy and law to protect the rights of those who are subject to any search.

Searches shall not be used for intimidation, harassment, punishment, or retaliation.

901.3 FIELD AND TRANSPORTATION SEARCHES

An officer shall conduct a custody search of an individual immediately after his/her arrest, when receiving an individual from the custody of another, and before transporting a person who is in custody in any department vehicle.

Whenever practicable, a custody search should be conducted by an officer of the same sex as the person being searched. If an officer of the same sex is not reasonably available, a witnessing officer should be present during the search.

901.3.1 CUSTODY SEARCHES OF TRANSGENDER INDIVIDUALS

All searches of transgender individuals will conform to departmental procedures regarding the use of an officer of the same gender, if available. This will be determined by the gender listed on a government-issued identification or database. In the event that the individual does not have identification nor can be identified using a government database such as DMV or BCI, asking

Salt Lake City Police Department

SLCPD Policy Manual

SLCPD Policy Manual

Custodial Searches

an individual if they have or don't have male genitalia is appropriate, and the searching officer requested will be based on the response.

If requested by the person in custody, a department member of the individual's gender identity/ expression should be present, when practical, to observe the search. When practical, this observer should be a supervisor.

901.4 SEARCHES AT POLICE FACILITIES

Custody searches shall be conducted on all individuals in custody prior to or immediately upon entry to the Salt Lake City Police Department facilities. The search should be conducted by a member of the same sex as the individual being searched. If a member of the same sex is not available, a witnessing member must be present during the search.

Custody searches should also be conducted any time an individual in custody enters or re-enters a secure area, or any time it is reasonably believed that a search is necessary to maintain the safety and security of the facility.

901.4.1 PROPERTY

Members shall take reasonable care in handling the property of an individual in custody to avoid discrepancies or losses. Property retained for safekeeping shall be kept in a secure location until the individual is released or transferred.

Some property may not be accepted by a facility or agency that is taking custody of an individual from this department, such as weapons or large items. These items should be retained for safekeeping in accordance with the Property and Evidence Policy.

901.5 STRIP SEARCHES

No individual in temporary custody at any Salt Lake City Police Department facility shall be subjected to a strip search unless there is reasonable suspicion based upon specific and articulable facts to believe the individual has a health condition requiring immediate medical attention or is concealing a weapon or contraband. Factors to be considered in determining reasonable suspicion include but are not limited to:

- (a) The detection of an object during a custody search that may be a weapon or contraband and cannot be safely retrieved without a strip search.
- (b) Circumstances of a current arrest that specifically indicate the individual may be concealing a weapon or contraband.
 - 1. A felony arrest charge or being under the influence of a controlled substance should not suffice as reasonable suspicion absent other facts.
- (c) Custody history (e.g., past possession of contraband while in custody, assaults on department members, escape attempts).
- (d) The individual's actions or demeanor.
- (e) Criminal history (i.e., level of experience in a custody setting).

Salt Lake City Police Department

SLCPD Policy Manual

SLCPD Policy Manual

Custodial Searches

No transgender or intersex individual shall be searched or examined for the sole purpose of determining their individual genital status. If it is necessary to determine their individual genital status, it may be determined during conversations with the person or by reviewing official records.

Nothing in this section prohibits the lawful execution of a valid search warrant that meets the definition of a strip search.

901.5.1 STRIP SEARCH PROCEDURES

Strip searches at Salt Lake City Police Department facilities shall be conducted as follows:

- (a) Authorization from the Watch Commander or Investigations Unit Lieutenant shall be obtained prior to the strip search.
- (b) All members involved with the strip search shall be of the same sex as the individual being searched, unless the search is conducted by a medical practitioner.
- (c) All strip searches shall be conducted in a professional manner under sanitary conditions and in a secure area of privacy so that it cannot be observed by those not participating in the search.
- (d) A second member of the same sex shall also be present during the search, for security and as a witness to the finding of evidence.
- (e) Members conducting a strip search shall not touch the breasts, buttocks or genitalia of the individual being searched.
- (f) The primary member conducting the search shall prepare a written report to include:
 1. The facts that led to the decision to perform a strip search.
 2. The reasons less intrusive methods of searching were not used or were insufficient.
 3. The authorization for the search, obtained from the Watch Commander or Investigations Unit Lieutenant.
 4. The name of the individual who was searched.
 5. The name and sex of the members who conducted the search.
 6. The name, sex and role of any person present during the search.
 7. The time and date of the search.
 8. The place at which the search was conducted.
 9. A list of the items, if any, that were recovered.
 10. The facts upon which the member based his/her belief that the individual was concealing a weapon or contraband.

901.5.2 SPECIAL CIRCUMSTANCE FIELD STRIP SEARCHES

A strip search may be conducted in the field with Watch Commander or Investigations Unit Lieutenant authorization and only in necessary circumstances, such as when:

Salt Lake City Police Department

SLCPD Policy Manual

SLCPD Policy Manual

Custodial Searches

- (a) There is probable cause to believe that the individual is concealing a weapon or other dangerous item that cannot be recovered by a more limited search.
- (b) There is probable cause to believe that the individual is concealing controlled substances or evidence that cannot be recovered by a more limited search, and there is no reasonable alternative to ensure the individual cannot destroy or ingest the substance during transportation.

These special-circumstance field strip searches shall only be authorized and conducted under the same restrictions as the strip search procedures in this policy.

901.6 PHYSICAL BODY CAVITY SEARCH

Physical body cavity searches shall be subject to the following:

- (a) No individual shall be subjected to a physical body cavity search without approval of the Watch Commander or an Investigations Unit Lieutenant and only upon a search warrant. A copy of any search warrant and the results of the physical body cavity search shall be included with the related reports and made available, upon request, to the individual or authorized representative (except for those portions of the warrant ordered sealed by a court).
- (b) Only licensed medical personnel may conduct a physical body cavity search.
- (c) Except for the medical personnel conducting the search, persons present must be of the same sex as the individual being searched. Only the necessary department members needed to maintain the safety and security of the medical personnel shall be present.
- (d) Privacy requirements, including restricted touching of body parts and sanitary condition requirements, are the same as required for a strip search.
- (e) All such searches shall be documented, including:
 - 1. The facts that led to the decision to perform a physical body cavity search of the individual.
 - 2. The reasons less intrusive methods of searching were not used or were insufficient.
 - 3. The Watch Commander or Investigations Unit Lieutenant's approval.
 - 4. A copy of the search warrant.
 - 5. The time, date and location of the search.
 - 6. The medical personnel present.
 - 7. The names, sex and roles of any department members present.
 - 8. Any contraband or weapons discovered by the search.

901.7 REVISIONS

Enacted: April 23, 2018

Revised: October 22, 2019

Chapter 10 - Personnel

Recruitment and Selection

1000.1 PURPOSE AND SCOPE

This policy provides a framework for employee recruiting efforts and identifying job-related standards for the selection process. This policy supplements the rules that govern employment practices for the Salt Lake City Police Department and that are promulgated and maintained by the Department of Human Resources.

Employees wanting to participate in the Police Department Employee Recruitment Program, which compensates Department employees who assist in the recruitment and hiring of police officer candidates, should refer to the Department Employee Recruitment Program Procedure in the Procedure Manual.

1000.2 POLICY

In accordance with applicable federal, state, and local law, the Salt Lake City Police Department provides equal opportunities for applicants and employees regardless of actual or perceived race, ethnicity, national origin, religion, sex, sexual orientation, gender identity or expression, age, disability, pregnancy, genetic information, veteran status, marital status, and any other classification or status protected by law. The Department does not show partiality or grant any special status to any applicant, employee, or group of employees unless otherwise required by law.

The Department will recruit and hire only those individuals who demonstrate a commitment to service and who possess the traits and characteristics that reflect personal integrity and high ethical standards.

1000.3 SELECTION PROCESS

The Department shall actively strive to identify a diverse group of candidates that have in some manner distinguished themselves as being outstanding prospects. Minimally, the Department will employ a comprehensive screening, background investigation, and selection process that assesses cognitive and physical abilities and includes review and verification of the following:

- (a) A comprehensive application for employment to include:
 1. Education verification
 2. Employment history
 3. Verification of qualifying credentials
 4. Review of relevant national or state decertification resources if available
- (b) Driving record
- (c) Reference checks, personal and professional
- (d) Citizenship eligibility, including U.S. Citizenship and Immigration Services (USCIS) Employment Eligibility Verification Form I-9 and acceptable identity and employment authorization documents. This required documentation should not be requested until

Salt Lake City Police Department

SLCPD Policy Manual

SLCPD Policy Manual

Recruitment and Selection

a candidate is hired. This does not prohibit obtaining documents required for other purposes.

- (e) Information obtained from public internet sites
- (f) Financial history consistent with the Fair Credit Reporting Act (FCRA) (15 USC § 1681 et seq.)
- (g) Local, state and federal criminal history record checks
- (h) A truth verification exam
- (i) Medical and psychological examination (may only be given after a conditional offer of employment)

1000.4 BACKGROUND INVESTIGATION

Every candidate shall undergo a thorough background investigation to verify his/her personal integrity and high ethical standards, and to identify any past behavior that may be indicative of the candidate's unsuitability to perform duties relevant to the operation of the Salt Lake City Police Department (Utah Code 53-6-203; Utah Code 53-6-302).

1000.4.1 REVIEW OF SOCIAL MEDIA SITES

Due to the potential for accessing unsubstantiated, private or protected information, the Administration Division Commander shall not require candidates to provide passwords, account information or access to password-protected social media accounts (Utah Code 34-48-201). However, investigators may review public information posted on social media by the applicants.

1000.4.2 DOCUMENTING AND REPORTING

The background investigator shall summarize the results of the background investigation in a report that includes sufficient information to allow the reviewing authority to decide whether to extend a conditional offer of employment. The report shall not include any information that is prohibited from use in making employment decisions. The report and all supporting documentation shall be included in the candidate's background investigation file.

1000.4.3 RECORDS RETENTION

The background report and all supporting documentation shall be maintained in accordance with the established records retention schedule.

1000.5 EMPLOYMENT STANDARDS

All candidates shall meet the minimum standards required by state law (Utah Code 53-6-203; Utah Code 53-6-302). Candidates will be evaluated based on merit, ability, competence and experience, in accordance with the high standards of integrity and ethics valued by the Department and the community.

Validated, job-related, and nondiscriminatory employment standards shall be established for each job classification and shall minimally identify the training, abilities, knowledge, and skills required to perform the position's essential duties in a satisfactory manner. Each standard should include performance indicators for candidate evaluation.

Salt Lake City Police Department

SLCPD Policy Manual

SLCPD Policy Manual

Recruitment and Selection

1000.5.1 STANDARDS FOR OFFICERS

Candidates shall meet the minimum standards established by the Utah Peace Officer Standards and Training (POST) Council (Utah Code 53-6-203). In addition to the standards established by POST, the department may establish additional standards concerning peace officer candidates (Utah Code 53-6-207):

- (a) Citizen of the United States. Applicants who apply for employment with the Salt Lake City Police Department must be citizens of the United States on the date of the first examination. Applicants also must demonstrate the ability to read, write, understand, and speak the English language.
- (b) At least 21 years of age. Applicants applying for the position of Police Officer must be at least twenty-one (21) years of age, by the time of certification as a law enforcement officer.
- (c) High school graduate or possess an equivalent achievement. All Salt Lake City Police Department positions require at least a high school diploma or general education diploma (G.E.D.). Some positions may require additional education and/or experience as required within the minimum qualifications section of the job description.
- (d) Not have been convicted of a crime for which the candidate could be punished by imprisonment.
- (e) Demonstrate good moral character as determined through a background investigation.
- (f) Be free of any physical, emotional, or mental condition that might adversely affect the performance of the candidate's duties as a peace officer. Police Officer applicants must also take a psychological examination and evaluation. Police Officer applicants must successfully pass a City provided medical examination. Specific questions as to the suitability of a candidate's physical condition will be determined during the medical examination. Applicants must be able to meet the physical qualifications of specific job categories.
- (g) A criminal background check of local, state, and national criminal history files. Police Officer applicants are not eligible for employment if they have been convicted of any domestic violence-related offense. Other domestic incidents or reports will be looked at on a case-by-case basis. Applicants who have been convicted of a DUI of alcohol or drugs, or who have pled guilty to a lesser charge, shall not be allowed to make an application prior to two (2) years from the date of conviction. Applicants who have been convicted of more than two DUIs, or who have pled guilty to a lesser charge, shall not be allowed to continue in the process. Age may be taken into consideration if at the time of the offense the applicant was a juvenile. Applicants may not have any open and pending criminal or traffic offenses that have not been resolved.
- (h) Not prohibited from possessing a firearm under state or federal law.
- (i) Tattoos and personal appearance must be in compliance with the Personal Appearance Standards Policy upon hire. The applicant must be able to comply with all grooming standards as indicated therein.
- (j) Any use of the applicant's activity involving the abuse of alcohol will be considered in determining the suitability of the applicant.

Salt Lake City Police Department

SLCPD Policy Manual

SLCPD Policy Manual

Recruitment and Selection

- (k) Applicants for police officers are required to have a valid driver's license.
- (l) Applicants must demonstrate financial responsibility.
- (m) An applicant's work history will be considered including completeness of job history information provided.
- (n) Applicants must successfully pass all examinations as required by the City.
- (o) Applicant's associations with known felons, criminal enterprise, street gang members, and/or groups advocating violence and/or subversive goals will be individually reviewed. These associations include family members.

1000.5.2 DISQUALIFICATION GUIDELINES

Disqualification of applicants will be determined by the background team which may include the background investigator(s), a Sergeant, a Lieutenant, and/or a member of the Human Resources Department. At a minimum, the background team will be comprised of the applicant's background investigator, a neutral background investigator, and a Salt Lake City Police Department Lieutenant, Captain, or Chief.

Candidates may be disqualified at any point during the background investigation if disqualifying acts or behavior are found. The background investigator will, however, gather sufficient information about the applicant that a fair and impartial decision can be made by the background team. A summary outlining the reason(s) for disqualification will be reviewed by the background team and attached to the applicant's background report.

Applicants will not be disqualified based upon race, color, religion, gender, age, national origin, disability, or sexual orientation.

Other than as previously stated above, a candidate may be permanently disqualified for consideration for employment if they have committed disqualifying acts such as:

- Falsification of any records or false statements during application for employment. Applicants will be disqualified from the process if false information is discovered. Incomplete applications or omissions on other requested documents will delay the hiring process and may disqualify the application from the selection process or employment.
- Previous felony convictions. Applicants may not have been convicted of a crime for which the applicant could have been punished by imprisonment in a federal penitentiary or by imprisonment in the penitentiary of this state or another state. Felony convictions as a minor (under 18 years of age) may not be an automatic disqualifier and will be individually reviewed. Involvement in a felony crime, whether arrested and/or convicted, may also be the reason for disqualification.
- Previous illegal manufacturing, cultivating or distributing of narcotics.
- Applicants may not have used any illegal drug while employed in any law enforcement or prosecutorial position, or while employed in a position that carries a high level of public trust.

Salt Lake City Police Department

SLCPD Policy Manual

SLCPD Policy Manual

Recruitment and Selection

- Demonstrating a pattern of dishonesty, low moral character, drug abuse, or criminal involvement.
- Applicant's driving records are reviewed and excessive moving citations and the driver's age at the time of the offenses will be considered and may disqualify the applicant.
- An applicant may be disqualified for any military discharge less than honorable. Discharges for anything less than honorable will be considered on a case-by-case basis. An applicant will be disqualified for any dishonorable discharge.

Temporary disqualifications may also be used to give the applicant time to demonstrate that disqualifying behaviors have ceased and they have established a pattern of integrity, personal responsibility, and lawful conduct. The length of a temporary disqualification will be determined by the background team and, as appropriate, with the applicant's prior behavior.

- Applicants may not have used any Schedule I or II rated drug (with the exception of marijuana) within two (2) to four (4) years prior to the application closing date. Schedule I and II drugs include, but are not limited to:
 - Stimulants - amphetamine, methamphetamine, cocaine, crack, or MDMA (ecstasy)
 - Hallucinogens - psilocybin mushrooms, mescaline, peyote, ketamine, DMT, gamma hydroxybutyrate (GHB) or foxy/AMT (tryptamine)
 - Opiates - opium, morphine, heroin, methadone, qualude pills, or thai sticks
- Applicants may not have used any Schedule III or IV drug, marijuana, or other restricted drugs within one (1) year prior to the application closing date. Other drugs (including their chemical derivatives and synthetic equivalents) include marijuana, anabolic steroids, hashish, DXM (dextromethorphan), amyl nitrates, cannabis, and inhalants. Exceptions to this include provisions under the Utah Medical Cannabis Act (UC 26-61A-701). Abuse of prescription drugs, whether prescribed or non-prescribed, or a demonstrative pattern of drug use, will be individually considered and may be grounds for disqualification. Failure to fully disclose any and all illegal drug use will automatically disqualify the applicant from the process.
- Criminal Conviction waiting periods use the following breakdown:
 - Involvement in a felony crime for which you were not convicted of a felony requires a four (4) year waiting period from the date of involvement.
 - Conviction of or involvement in misdemeanor crimes concerning drugs/controlled substances require a two (2) to four (4) year waiting period from the date of conviction or involvement depending on the type of drug/controlled substances involved.
 - Conviction of or involvement in class A misdemeanor crimes involving physical violence requires a four (4) year waiting period from the date of conviction or involvement.

Salt Lake City Police Department

SLCPD Policy Manual

SLCPD Policy Manual

Recruitment and Selection

- Conviction of or involvement in class A misdemeanor crimes that do not involve an act of violence require a three (3) year waiting period from the date of conviction or involvement.
- Conviction of or involvement in class B misdemeanor crimes involving an act of violence, possession or use of a controlled substance, or providing false information to obtain certification requires a two (2) year waiting period from the date of conviction or involvement.
- Conviction of or involvement in class B misdemeanor crimes involving sexual acts, harassment, theft, crimes of dishonesty, the use of alcohol, or the use of prescription drugs requires a one (1) year waiting period from the date of conviction or involvement.
- Conviction of or involvement in class B misdemeanor crimes not including any of the above mentioned things requires a six (6) month waiting period from the date of conviction or involvement.
- Conviction of or involvement in class C misdemeanor crimes or infractions requires a three (3) month waiting period from the date of conviction or involvement.
- The loss of driving privileges will make the applicant ineligible, if within the last two (2) years from the date of testing.

1000.6 RE-HIRE OF PREVIOUS EMPLOYEES

Applicants who have previously worked for the Police Department, and separated their employment in good standing may be considered for an accelerated hiring process under the following conditions:

- All re-hires will be evaluated on a case-by-case basis, taking into account the needs of the department at that time.
- If the employee was separated from employment for less than one year and has not activated their pension through the Utah State Retirement System, if approved, may return at the same rate of pay and seniority. There is no guarantee that the applicant will be returned to the same position or rank.
- If the employee was previously a sworn police officer, they must have maintained their certification as a police officer, or must be able to have it reinstated. If a returning police officer returns from separation after one year, it will be at the discretion of the Chief of Police as to the level of retraining that will need to take place. This may include attending the entire police academy if deemed appropriate.
- All re-hire employees will be subject to a thorough background investigation as if they were any other police officer candidate.

1000.7 PROBATION

Upon appointment to an entry-level position in the Department, an employee is placed on probation, and sworn employees are issued a temporary Department training identification number. A permanent identification number indicating Department seniority will be issued based

Salt Lake City Police Department

SLCPD Policy Manual

SLCPD Policy Manual

Recruitment and Selection

upon overall placement in initial Department training. The duration of the probationary period, as set by the Civil Service Rules and Regulations, is 6 months for most civilian employees and 12 months for dispatchers and sworn employees.

The probationary period is the final phase of the selection process for newly hired employees. During probation the employee is trained, closely observed, and evaluated. The employee is expected to meet all established training standards.

If it becomes evident during the probationary period an employee is unable or unwilling to perform in the position in a satisfactory manner, the appointing power may terminate the employee's employment.

1000.8 SENIORITY AND IDENTIFICATION NUMBERS

Department ID numbers for sworn personnel are assigned according to the following criteria:

- Hire Date: Date of hire is the first determining factor for seniority. Employees with earlier hire dates will have greater department seniority.
- In-house Academy Finish: Recruits are ranked according to their success during the department's in-house academy. This ranking is the second factor in determining seniority. Employees finishing higher at the conclusion of the in-house academy will have greater department seniority.

Department ID numbers for non-sworn personnel will be assigned based on applicable MOU or compensation plans.

1000.9 RECRUITMENT

The Public Relations Director should employ a comprehensive recruitment strategy to recruit employees from a qualified and diverse pool of candidates.

1000.10 REVISIONS

Enacted: May 14, 2018

Revised June 13, 2023

Evaluation of Employees

1001.1 PURPOSE AND SCOPE

The Department's employee performance evaluation system is designed to record work performance for both the Department and the employee, providing recognition for good work and developing a guide for improvement.

1001.2 POLICY

The Department establishes acceptable standards of performance for all positions within the Department. Supervisors are required to evaluate the work of their subordinates annually, focusing on each employee's strengths and weaknesses, in order to improve performance and recognize good work. Performance evaluations become a permanent part of employees' personnel records.

Every employee shall receive an annual employee evaluation from their supervisor within the month of August. Supervisors will place completed and signed evaluations in the designated storage location by August 31st of each year.

Additionally, when an employee is transferred to another Division, the employee's immediate supervisor must complete a performance evaluation of that employee.

Employee performance evaluations will be conducted for both sworn and civilian employees. This includes full-time, part-time, and seasonal employees.

1001.3 EVALUATION PROCESS

Evaluations will be completed by the employee's immediate supervisor. If the employee had other supervisors during the time period being evaluated, the evaluating supervisor should discuss the employee's performance with those supervisors to assist in the evaluation process. Once completed, the evaluating supervisor will provide the evaluation to their supervisor for review and signature before discussing the evaluation with the employee being evaluated. The purpose of this review is to check the evaluation for fairness, impartiality, uniformity and consistency.

After the evaluating supervisor has completed the evaluation and their supervisor has reviewed and signed it, arrangements shall be made for a private discussion of the evaluation with the employee being evaluated. The supervisor will discuss the results of the evaluation and clarify any questions the employee may have. Areas needing improvement and goals for reaching the expected level of performance will be identified and discussed. The supervisor should also provide relevant counseling regarding advancement, specialty positions, and training opportunities. The supervisor and employee will sign and date the evaluation.

1001.3.1 RATINGS

When completing an employee performance evaluation, the rater will place a check mark in the column that best describes the employee's performance. The definition of each rating category is as follows:

Outstanding - Is actual performance well beyond that required for the position.

Salt Lake City Police Department

SLCPD Policy Manual

SLCPD Policy Manual

Evaluation of Employees

Meets Standards - Is the performance of a fully competent employee. It means satisfactory performance that meets the standards required for the position.

Needs Improvement - Is a level of performance less than that expected of a fully competent employee and less than standards required for the position. A "Needs Improvement" rating must be thoroughly discussed with the employee.

Unacceptable - Performance is inferior to the standards required for the position. It is very inadequate or undesirable performance that cannot be tolerated.

Space for written comments is provided at the end of the evaluation. This section allows the rater to document the employee's strengths, weaknesses, and to make suggestions for improvement. Any rating under any job dimension marked unacceptable, needs improvement, or outstanding shall be substantiated with written comments.

1001.3.2 PROCEDURE

The employee evaluation form is located on the P Drive in the Employee Performance Evaluation Form folder. The form should be saved to the evaluator's desktop or other intranet storage drive. Once the form is completed, a hard copy shall be printed for review with, and signature of, the employee being evaluated. Once reviewed and signed, the evaluation shall be saved to the Z Drive in the folder for the year in which the annual evaluation is completed. If a folder for the year in which the annual evaluation takes place is not already created, the supervisor will create a new folder using the following format: 2018. The folder is protected through a permissions process that allows a supervisor in the upward chain of command of the evaluated employee to view the evaluation.

After the printed copy of the evaluation has been approved by the evaluator's supervisor, reviewed with the employee being evaluated, and all necessary signatures have been obtained, the evaluating supervisor will deliver the hard copy to their Division Commander or designee. All hard copies of evaluations will be delivered to the City's Human Resources Department for filing and retention. The evaluated employee may keep a copy of the performance evaluation if they desire to do so.

1001.4 UNSATISFACTORY PERFORMANCE EVALUATIONS

. An employee who fails to meet standards must be reevaluated in four months. The supplementary evaluation form will be added to the original evaluation form to finalize the annual review of the employee's performance.

1001.5 REVISIONS

Enacted: March 5, 2018

Revised: June 29, 2020

Promotion, Transfer, and Reassignment

1002.1 PURPOSE

This policy aims to establish the policy for promotions, transfers, and reassignments within the Salt Lake City Police Department.

1002.1.1 SCOPE

This policy establishes guidelines for transfers, and the posting and filling of vacancies, for all employees at the rank of officer/detective. The intent of allocating personnel to a specific assignment is to establish optimum effectiveness within the Department while considering individual employees' professional and personal growth desires and objectives.

This policy does not apply to transfers or reassignments that result in the movement of an employee from one job or position to a different job or position of different pay or a different pay grade. Moves of this nature are governed by the applicable memorandum of understanding (MOU) and city policy.

1002.1.2 DEFINITIONS

Interdivisional Transfer - A transfer that is open to any eligible and qualified employee within the Department for the purpose of filling a vacancy.

Intradivisional Transfer - A transfer that is open to any eligible and qualified employee within a Division for the purpose of filling a vacancy.

Reassignment - An action initiated by a Division Commander, and approved by the Officer of the Chief, which moves an employee from one job or position to a different job or position with equal pay and an equal pay grade.

Vacancy - An unoccupied full-time or collateral position outside of a patrol officer status, either existing or newly created.

1002.2 PROMOTIONS

The department has established promotional paths that allow upward mobility for all employees. The Salt Lake City Police Department and human resources establish eligibility standards for sworn positions, including promotions. All promotions and promotional testing will comply with the rules stated in the promotional announcement. The Administrative Deputy Chief shall be responsible for coordinating with human resources for the administration of promotional processes.

1002.3 TRANSFERS

The Department will seek to attain the following objectives in personnel distribution:

- (a) openness, fairness, and objectivity in selecting employees for posted vacancies
- (b) increased and impartial transfer opportunities for affected employees
- (c) maximum advance notice to employees approved for transfer

Salt Lake City Police Department

SLCPD Policy Manual

SLCPD Policy Manual

Promotion, Transfer, and Reassignment

- (d) constructive feedback to employees for career development and future selection processes

No employee has a property right to a specific assignment within the Department. Transfers allow for individual growth and increased job knowledge for employees.

1002.3.1 INTERDIVISIONAL TRANSFER VACANCY GUIDELINES

Division Commanders will request from their Deputy Chief to create a vacancy notice when it is determined a vacancy does or will exist and an eligibility list does not exist, has expired, or is being discontinued. If a vacancy announcement is approved, a Chief's Memorandum will be issued and shall include the following:

- (a) title of the position
- (b) a job description or an attachment containing a job description
- (c) regular duty hours or "hours vary," when necessary
- (d) minimum requirements to qualify for the assignment
- (e) desired qualifications for the assignment (e.g., specialized training, skills, credentials, etc.)
- (f) all documents required
 1. all vacancy announcements at a minimum shall require the submission of a resume and the employee's most recent annual employee evaluation.
- (g) outlined selection process
- (h) the name and contact information of the supervisor that should be contacted with questions and requests for feedback

Absent extraordinary circumstances, a vacancy announcement will provide at least 10 calendar days of notice to eligible employees to apply.

Employees will receive an email confirming their required documents were received with an anticipated timeline of events for the selection process. Emails should come from the supervisor overseeing the selection process or an administrative assistant that is responsible for the collection of the documents.

1002.3.2 DISQUALIFICATIONS

An employee shall not be eligible for transfer if they:

- (a) have received negative performance documentation involving a letter of warning, time off, demotion, or reassignment within the past 365 calendar days
- (b) have received a rating of "Unacceptable" on their annual employee evaluation within the past 365 calendar days
- (c) have documented abuse of leave time within the last 365 calendar days. Documentation must be in writing and as part of corrective action enacted by a supervisor.

Salt Lake City Police Department

SLCPD Policy Manual

SLCPD Policy Manual

Promotion, Transfer, and Reassignment

Employees that meet one or more of the above disqualification criteria may apply for transfers when vacancies are announced, but will not be allowed to transfer until the outlined timelines have been met.

Eligible employees on light duty, modified duty, or administrative leave status may apply for a transfer, but their status may be considered when determining if/when a transfer should occur.

1002.3.3 SELECTION PROCESS

The supervisor overseeing the selection process for any assignment within the department will determine the process's metrics and course of action. A selection process may include the use of:

- (a) boards, interviews, and panels
- (b) written testing
- (c) practical exercises
- (d) pre-requisite trainings
- (e) letters of recommendation and/or commendations
- (f) job-specific evaluation criteria.
- (g) other job-relevant metrics

At a minimum, a selection process will include an interview between the employee and the supervisor(s) over the unit where the vacancy exists. Employees that fail to appear or reschedule an interview will forfeit the opportunity for an interview.

If a significant number of employees apply for a vacancy, the supervisor over the selection process may restrict the selection process to those employees who meet the desired qualifications rather than the minimum qualifications.

Factors that should be considered for selection include:

- (a) departmental seniority
- (b) quality and volume of work
- (c) disciplinary history
- (d) personal motives
- (e) specialized training and or education
- (f) prior experience
- (g) ability to work within the affected unit.

The supervisor(s) overseeing the selection process should meet with the Division Commander or designee as soon as practicable after the completion of the selection process to assess the selection recommendations. The Division Commander or designee may request an interview with any of the employees if they have questions or concerns about a supervisory recommendation. The Division Commander will be responsible for the final approval of personnel selection.

Salt Lake City Police Department

SLCPD Policy Manual

SLCPD Policy Manual

Promotion, Transfer, and Reassignment

Employees will be notified by the Division Commander or designee of their selection or non-selection for the vacancy. This will be accomplished by phone, email, or memorandum.

Employees are encouraged to contact the responsible supervisor(s) for feedback on their performance during the selection process. When contacted, applicable supervisors shall provide constructive feedback to the employee to assist in career development.

1002.3.4 TRANSFER EVALUATIONS AND PROBATION

Employees transferring to a new Division must meet with their current supervisor before transferring to their new assignment. The transferring employee's supervisor shall complete an employee evaluation for the employee if they have not already completed an annual evaluation within the same trimester.

Employees transferring to an assignment shall be placed on a 180-day probation to determine their suitability for the assignment. Failure to complete the transfer probation successfully will result in the employee being reassigned to any open assignment or position based on the needs of the Department.

1002.3.5 ELIGIBILITY LISTS

An eligibility list generated from a selection process will remain active for a period not to exceed 365 calendar days. The eligibility list will only apply to vacancies of the exact description of the vacancy for which the eligibility list was established.

If a Division Commander determines that eligibility lists do not contain employees that would be appropriate for an assignment they may repost the vacancy and create a new selection process based on the current needs of the unit. If this occurs, the Division Commander or their designee shall inform any remaining employee from the eligibility list of their decision. Upon request, constructive feedback shall be provided to an employee on an expiring list for career development purposes.

If no applications are received, a vacancy may be reposted. Additionally, the Division Commander may identify and request an involuntary reassignment of an employee within their Division, with the approval of the Chief of Police.

1002.3.6 INTRADIVISIONAL TRANSFER VACANCY GUIDELINES

Flexibility within Divisions is necessary for operational continuity and employee-related circumstances. Division Commanders should balance Divisional operational and employee needs when making intradivisional transfers. While Division Commanders should generally utilize the same selection process and guidelines for intradivisional transfers, they are not required to do so when mitigating factors dictate.

1002.4 REASSIGNMENTS

A reassignment may be proposed to maximize an employee's ability to succeed in the workplace. If approved by the Officer of the Chief, reasonable care will be taken to mitigate the personal effects on the employee.

Salt Lake City Police Department

SLCPD Policy Manual

SLCPD Policy Manual

Promotion, Transfer, and Reassignment

Notice of the reassignment will be given at least fourteen (14) days before the change occurs.

Reassignments will not be used as an initial corrective action strategy. If an employee's performance and/or conduct is in question, the Division Commander should attempt to correct deficiencies through additional training or a performance improvement plan before reassignment. All efforts to train or correct the employee's undesirable behavior should be documented. If, after the corrective measures have been provided, the Division Commander wants to reassign the employee to another workgroup within the same rank and pay grade, they should request approval from the Office of the Chief.

If a reassignment is part of an outcome of a formal disciplinary proceeding, that will be stated explicitly in the disciplinary letter (this does not restrict the types of reassignments described above).

1002.5 JOB DESCRIPTION MAINTENANCE

A documented review of job descriptions for all employee positions will occur at least once every four years. Job descriptions will be available to all personnel.

1002.6 REVISIONS

Enacted: May 14, 2018

Revised: August 16, 2022

Revised: April 4, 2023

Complaints Against Personnel - Internal Investigations

1003.1 PURPOSE AND SCOPE

The purpose of this policy is to provide guidelines for the reporting, investigation, and disposition of complaints regarding the conduct of members of this Department.

This policy does not apply to routine initial inquiries, coaching, instruction, or direction provided to members by their supervisor.

1003.1.1 DEFINITIONS

Complaint - Any allegation of misconduct or improper job performance against any Department member that, if true, would constitute a violation of any Department policy, City policy, federal law, state law, or local law.

Some complaints are initiated by individuals who are unfamiliar with Salt Lake City Police Department policy/procedure, standards of conduct, and general police practice; or have misperceptions and/or unrealistic expectations of police authority. As such, an inquiry about member conduct that, even if true, does not meet the definition of a complaint as listed above shall not be considered a complaint.

IA Pro – The case management system used by the Internal Affairs Unit.

BlueTeam – The software that allows officers and supervisors to enter and manage incidents from the field. BlueTeam facilitates the routing of incidents through the chain of command.

Category 1 (Serious) Allegations – These may include, but are not limited to:

- (a) Improper exercise of police authority.
- (b) Misconduct pertaining to alcohol, drugs, and/or sex.
- (c) Harassment or threats.
- (d) Failure to take appropriate police action.
- (e) Inappropriate use of force.
- (f) Misuse of information systems.
- (g) Failure to report misconduct.
- (h) Assault by an officer or other Department member.
- (i) Improper handling of evidence.
- (j) Unlawful or inappropriate search and/or seizure.
- (k) Unlawful or inappropriate arrest.
- (l) Civil rights violations.
- (m) Criminal conduct by an officer or Department member.

Salt Lake City Police Department

SLCPD Policy Manual

SLCPD Policy Manual

Complaints Against Personnel - Internal Investigations

Category 2 (Minor) Allegations – A complaint that may be investigated within the involved member's Division. Minor allegations may include, but are not limited to:

- (a) Personal contacts.
- (b) Rudeness.
- (c) Profanity.
- (d) Improper use of equipment.
- (e) Improper vehicle impound.
- (f) Police traffic or parking violations.

Facts or circumstances surrounding an incident may cause minor allegations to be investigated as serious allegations.

Miscellaneous Information Files (M-Files) – M-Files are complaints or information received that are not investigated due to the lack of specific information required for investigation or are so minor in nature that they can be handled by an initial inquiry at the Division level.

Initial Inquiry –The initial inquiry is an essential step in the complaint process for determining the initial validity of the complaint and the proper assignment of the investigation. This includes gathering any information relevant to the complaint, conducting an interview with the complainant, preserving evidence, and locating and interviewing other officers or civilian witnesses who may have knowledge of the incident. An initial inquiry may also involve an informal interview with the subject member.

Pre-Determination Hearing – A hearing in which a member is allowed to respond to allegations of misconduct. A member will be provided with a notice of the charges, a statement of the grounds for the charges, and evidence relied upon before the hearing takes place. Members will be given a reasonable amount of time, in compliance with the applicable Memorandum of Understanding (MOU), or City policy for non-represented members, to prepare for the hearing. This hearing takes place before the determination of any discipline takes place.

Written Warning – Written documentation specifically identifying a policy violation or deficiency, and the expected corrective action of the Department member. Written warnings are submitted to the Internal Affairs Unit and attached to the complaint file as well as the member's personnel file.

Suspension Without Pay – A specified time period for which a Department member is suspended from work without receiving pay.

Demotion – Removing one or more positions of rank or advancement from a Department member.

Termination – Ending a Department member's status as an employee with the Department.

1003.2 ACCEPTANCE OF COMPLAINTS

All complaints will be reviewed. No individual will be denied an opportunity to register a complaint regarding a Department member or the services of this Department. A Department member who becomes aware of alleged misconduct shall immediately notify a supervisor.

Salt Lake City Police Department

SLCPD Policy Manual

SLCPD Policy Manual

Complaints Against Personnel - Internal Investigations

Complaints against the Department or Department personnel will be accepted from:

- (a) An individual community member or group.
- (b) A third-party complaint.
- (c) A governmental agency.
- (d) An anonymous person.
- (e) A Department member.
- (f) The Department website.

1003.2.1 COMPLAINTS DISPUTING TRAFFIC CITATIONS OR MISDEMEANOR CHARGES

Complainants disputing a citation for traffic or misdemeanor charges should be directed to the courts for resolution. These complaints do not require documentation unless the alleged conduct of the Department member falls within a violation of Department policy, City policy, federal law, state law, or local law.

1003.2.2 INTERNAL COMPLAINTS

Whenever a member of this Department desires to initiate a formal complaint against another Department member, they are encouraged to direct the complaint through their chain of command. If the complaint is about a supervisor's conduct, the member may go to the next level in the chain of command. The member's Division commander will determine whether the complaint can be resolved within the Division or sent to the Internal Affairs Unit for investigation.

Department members may also make a complaint directly to the Internal Affairs Unit.

Department members shall not lodge complaints that are frivolous or malicious.

1003.3 COMPLAINTS AGAINST PERSONNEL – CHIEF OF POLICE NOTIFICATION

The Chief of Police will be informed of all serious allegations made against the Department or its members. The notification may be made verbally or in writing. Unless stated otherwise in this policy, the responsibility for the notification lies with the assigned staff of the Internal Affairs Unit who have the authority to report directly to the Chief of Police. The Internal Affairs Unit may also notify the Chief of Police of any other complaints it deems necessary.

1003.4 SUPERVISOR RESPONSIBILITY

A supervisor receiving a complaint shall conduct an initial inquiry. During the initial inquiry of a complaint, the supervisor should make every reasonable effort to obtain the names, addresses, and telephone numbers of additional witnesses. Photographs of alleged injuries shall be taken. Likewise, photographs shall be taken showing the absence of injuries, if applicable.

A supervisor shall gather all relevant information and shall document all received complaints (as defined in this policy) in BlueTeam, regardless of whether the officer involved is outside that supervisor's chain of command.

If during the initial inquiry, the supervisor determines:

Salt Lake City Police Department

SLCPD Policy Manual

SLCPD Policy Manual

Complaints Against Personnel - Internal Investigations

- (a) The complaint is a minor allegation; **and**
- (b) The supervisor deems that the complaint is not severe enough to bring discredit, criticism, or liability to the Department; **and**
- (c) During the initial inquiry, the supervisor can resolve the issue to the complainant's satisfaction.

The supervisor shall detail these circumstances in the BlueTeam entry, and the Internal Affairs Unit will categorize the entry as "Closed – Information Only".

If immediate action is necessary, or the alleged misconduct is severe enough to bring discredit, criticism, or liability to the Department, the supervisor must immediately notify the Watch Commander. The Watch Commander will ensure the immediate situation is handled according to proper policy and the appropriate Division commander is notified. The Division commander is responsible for notifying the appropriate Bureau Commander. The Bureau Commander is responsible for notifying the Chief of Police as soon as practicable.

1003.5 INTERNAL AFFAIRS RESPONSIBILITY

Internal Affairs investigations will address the policies and procedures of the department and the city. Unless otherwise directed, the Internal Affairs Unit Director will conduct the administrative review of cases investigated by the Internal Affairs Unit.

The Internal Affairs Unit is responsible for maintaining a comprehensive central index for all complaints received by the department. Such an index shall be secured.

1003.5.1 INTERNAL AFFAIRS RESPONSIBILITY - CATEGORY 1 ALLEGATIONS

Internal Affairs is responsible for investigating Category 1 allegations of misconduct.

1003.5.2 INTERNAL AFFAIRS RESPONSIBILITY - CATEGORY 2 ALLEGATIONS

The Internal Affairs Unit is responsible for investigating Category 2 allegations that have not been resolved by the employee's division, as well as Category 2 allegations that a supervisor has deemed severe enough to bring discredit, criticism, or liability to the department. Additionally, the Internal Affairs Unit may investigate any Category 2 allegation at its discretion, the Chief of Police may also direct the Internal affairs Unit to investigate any Category 2 allegation or to review any other matter.

1003.5.3 COMPLAINTS OF DISCRIMINATION

Notwithstanding any provision of this policy, complaints alleging discrimination, harassment, or retaliation are evaluated in accordance with applicable city policy. Human resources may conduct joint interviews when a complaint alleges both discrimination and violations of SLCPD policy.

Complaints of discrimination include, but are not limited to, race, color, religion, sex, national origin, age, disability, or genetic information.

Salt Lake City Police Department

SLCPD Policy Manual

SLCPD Policy Manual

Complaints Against Personnel - Internal Investigations

1003.5.4 INTERNAL AFFAIRS RESPONSIBILITY - M-FILES

When the Internal Affairs Unit receives an allegation that is determined to be an M-File, the Internal Affairs Investigators may do either of the following:

- (a) Enter the complaint into BlueTeam as "Closed - Information Only".
- (b) Send the complaint to the member's Division Command for an initial inquiry. If the Division Command decides the case has been handled without additional follow-up being necessary, the case will be returned to Internal Affairs as "Closed - Resolved by Division". If further investigation is needed, the M-File will be categorized and will be investigated according to policy.

1003.6 RELIEF FROM DUTY

When a complaint of misconduct is of a serious nature or when circumstances dictate that it would impose an unreasonable risk to the department, the department member, other members, or the public, a department member may be relieved from duty.

1003.7 ASSIGNMENT TO ADMINISTRATIVE LEAVE

At the discretion of the Chief of Police or his/her designee, employees may be placed on or removed from paid administrative leave in accordance with city policy or other applicable department policies.

Paid administrative leave is utilized by the department for various reasons and does not constitute corrective action or a presumption of wrongdoing.

Circumstances that may result in an employee being placed on paid administrative leave include, but are not limited to:

- The employee is charged with a criminal offense classified as a Class B misdemeanor or above.
- The employee has been arrested.
- The employee's presence may cause unnecessary disruption in the workplace.
- The employee is considered an involved officer in an Officer Involved Critical Incident.
- The employee has tested positive for a prohibited substance.

1003.7.1 ADMINISTRATIVE LEAVE PROCEDURE

[Salt Lake City Police Department Procedure Manual: 1009.3 ADMINISTRATIVE LEAVE - PROCEDURE](#)

1003.8 ALLEGATIONS OF CRIMINAL CONDUCT

When a complaint involves allegations of criminal conduct on the part of a Department member, the appropriate investigative agency will be contacted to conduct a criminal investigation. The Internal Affairs investigator(s) shall not generally be present during the interrogation of a member by a criminal investigator.

Salt Lake City Police Department

SLCPD Policy Manual

SLCPD Policy Manual

Complaints Against Personnel - Internal Investigations

The Chief of Police shall be notified as soon as practicable whenever a Department member is formally accused of criminal conduct, meaning the member is the focus of a criminal investigation in which criminal charges may be brought.

A member accused of criminal conduct shall be provided with all rights and privileges afforded to a civilian, and the member may not be administratively ordered to provide any information to a criminal investigator.

No information or evidence administratively coerced from a member may be provided to a criminal investigator.

Any law enforcement agency may release information concerning the arrest or detention of a peace officer, which has not led to a conviction.

1003.9 ADMINISTRATIVE INVESTIGATION OF COMPLAINTS

The investigator shall contact the complainant and inform them the complaint has been received for investigation, who will be conducting the investigation, and provide a general schedule for status notification. The investigator shall notify the complainant when the investigation has been completed and when a disposition has been reached. The following procedures shall be followed with regard to the accused department member(s):

- (a) The investigator will notify the accused member(s) and their immediate supervisor of the complaint, except when notification would compromise a potential criminal or covert investigation or when the investigator is able to determine that the complaint is unfounded or exonerated without the need for an interview.
- (b) The accused member shall be advised, in writing, of the following:
 - i. The nature of the matter being investigated and the specific allegation(s), if any, of misconduct.
 - ii. The date, time, and location of the incident that gave rise to the allegation(s).
 - iii. The right to have representation.
- (c) The investigator shall not be a person with significant personal knowledge of the facts giving rise to the investigation.
- (d) If an investigation discloses misconduct or improper job performance which was not alleged in the original complaint, the investigator shall investigate further.

1003.9.1 INTERVIEW

The following procedures shall be followed regarding interviews:

- (a) Interviews of accused Department members shall be conducted during reasonable hours and, if the member is off-duty, the member shall be compensated.
- (b) Prior to any interview, the member shall be advised of all rights and obligations pertaining to the *Garrity* rule.
 - i. The member will be given the appropriate form indicating they have been advised and understand their rights and obligations under the *Garrity* rule.

Salt Lake City Police Department

SLCPD Policy Manual

SLCPD Policy Manual

Complaints Against Personnel - Internal Investigations

- ii. The member will be directed to sign this form prior to an in-person interview. If the member provides written documentation in lieu of a formal interview, the member will be directed to make an affirmative acknowledgment that they received and understand the form in their written response.
- (c) The interview shall specifically and narrowly focus on the job-related conduct of the Department member.
- (d) The investigator shall not subject the member(s) under investigation to offensive language or threaten disciplinary action.
 - i. Notwithstanding, a member refusing to respond to questions or submit to interviews shall be informed that failure to answer questions that are narrowly and directly related to job-related conduct may result in disciplinary action.
- (e) The investigator shall not make any promise of reward or leniency as an inducement for the member to answer any questions.
- (f) A complete recording of the interview shall be made. The member may record the interview, provided it is with the knowledge of all parties present.
- (g) All Department members shall provide complete and truthful responses to questions posed during interviews.
- (h) Before a Department member is re-interviewed, the member shall be afforded a reasonable opportunity to review a complete recording of their previous interview(s).
- (i) In the event the member is re-interviewed regarding the information provided by the member in a previous interview, the member shall be afforded the opportunity to review a transcript of the relevant portion of the prior interview upon which the member will be re-interviewed. Such partial transcripts shall be provided by the Department. During the re-interview(s), the member shall have the right to have available the transcript described above. The member shall not be limited to the partial transcript provided by the Department and may bring a full transcript of the prior interview(s) to the re-interview, but such full transcript(s) must be created at the member's own expense.

1003.9.2 REPRESENTATION

The Department member shall have the right to have a representative or counsel present during all phases of the investigation. The member will be given a reasonable amount of time to obtain such representation without threat of disciplinary action.

In circumstances where a member is on paid administrative leave pending the outcome of a personnel investigation, interviews will be postponed no more than 5 calendar days from the initially scheduled interview to allow the member to obtain their desired representative. If the desired representative is unavailable within this time period, an alternative representative must be chosen.

The following procedures shall be followed by representatives:

- (a) The representative may not be a subject to, or witness of, the same complaint which gave rise to the investigation.

Salt Lake City Police Department

SLCPD Policy Manual

SLCPD Policy Manual

Complaints Against Personnel - Internal Investigations

- (b) Representatives shall not discuss the investigation(s), nor share or cause to be shared details of the investigation, including contents of interviews and/or evidence, with other representatives or others prior to the completion of interviews. Additionally, representatives will be required to sign a Non-Disclosure Agreement prior to the interview(s).
- (c) The representative is at the proceeding(s) to act as a representative on behalf of the member charged. Their role is to ensure the fairness of the proceedings and that the interview adheres to the guidelines specified in both the Memorandum of Understanding (MOU) and Department policy.
- (d) The representative may not interrupt, answer for, lead, or advise the member being interviewed as to the inquiry or question asked by the investigator.
- (e) The representative may object in an interview when:
 - i. A question, inquiry, or statement is made which is outside the scope of specific allegations or charges against the member.
 - ii. A question, statement, or inquiry is outside the scope of inquiry as to the member's fitness for duty.
 - iii. The representative may object at the time of the alleged improper question, statement, or inquiry. The investigator will note the objection and will have the prerogative to allow the representative to expound upon the grounds for the objection then, or have the representative wait until the end of the interview.
- (f) After the interview is completed, the investigator will ask the representative if he or she has any questions or comments to add to the interview. This will also be the time to offer the grounds for any objections that have not been stated previously.

1003.9.3 INSTRUMENTS FOR THE DETECTION OF DECEPTION

Department members may not be compelled to submit to a polygraph, Computerized Voice Stress Analysis (CVSA), Converus EyeDetect Test, or any other type of examination with an instrument purposed for the detection of deception. Disciplinary action may not be taken against members refusing to submit to these examinations, nor may any comment be entered anywhere in the investigator's notes or elsewhere indicating the member refused to submit to these examinations.

Testimony or evidence is not admissible at any subsequent administrative hearing, trial, or proceeding to the effect that the member refused to submit to these examinations.

1003.9.4 FITNESS FOR DUTY EVALUATIONS

Fitness for duty evaluations may be required as part of the investigative process. Evaluations are used to decide if members are physically, mentally, or emotionally able to perform their assigned duties. Fitness for duty evaluations may be required at the discretion of the Chief of Police.

1003.9.5 DRUG AND ALCOHOL TESTS

A member of this department may be administratively ordered to submit to a breath or urine test for alcohol and/or drugs as part of an administrative investigation. The requirements and procedures for these tests are outlined in the Drug- and Alcohol-Free Workplace Policy and Procedure.

Salt Lake City Police Department

SLCPD Policy Manual

SLCPD Policy Manual

Complaints Against Personnel - Internal Investigations

1003.9.6 FINANCIAL DOCUMENTS

Any member may be compelled to disclose personal financial information pursuant to proper legal process, if such information tends to indicate a conflict of interest with official duties.

1003.9.7 LINE-UPS

An investigator may use photographs of members and may require a member to submit to being photographed, for purposes of identification in an administrative investigation photo line-up.

Department members will not be required to participate in a physical line-up.

1003.9.8 ADMINISTRATIVE SEARCHES

City property that may be used by employees including assigned lockers, storage spaces, and other areas, including desks, offices, and vehicles, may be searched as part of an administrative investigation upon reasonable suspicion of misconduct.

Such areas may also be searched at any time by a supervisor for non-investigative purposes, such as obtaining a needed report, radio, or other document or equipment.

Department members shall have no expectation of privacy when using telephones, computers, radios, or communications provided by the Department.

1003.9.9 ADMINISTRATIVE INVESTIGATION GENERAL FORMAT

Administrative Investigations shall be fair, thorough, and defensible. The established burden of proof in administrative investigations is a preponderance of the evidence.

1003.10 CONCLUSION OF ADMINISTRATIVE INVESTIGATION

At the conclusion of an investigation, the investigator will prepare a case file.

The case will be forwarded, with the necessary documentation, to the Internal Affairs Director or designee for review. The Internal Affairs Unit will involve only those with a legitimate need-to-know status in the review of the investigation.

Complaint dispositions will be classified as:

- (a) **Exonerated** - The alleged incident did occur, but the actions of the member were justified, legal, and proper.
- (b) **Sustained** - The investigation disclosed a preponderance of the evidence to prove the allegation against the member, and the member's action(s) are in violation of a policy and/or procedure of the Department and/or the City.
- (c) **Not Sustained** - The investigation failed to disclose a preponderance of the evidence to clearly prove or disprove the allegation.
- (d) **Unfounded** - The alleged incident did not occur.

Division Commander shall be notified of the final case disposition unless it is unreasonable due to the number of complainants. A copy of the complainant notification letter will be included in the case file.

Salt Lake City Police Department

SLCPD Policy Manual

SLCPD Policy Manual

Complaints Against Personnel - Internal Investigations

Note: From approximately 2009 through 2018, the only two disposition classifications utilized by the Department were "Sustained" and "Not Sustained". As such, during that time period dispositions of "Not Sustained" encompassed the above dispositions of "Exonerated", "Unfounded", and "Not Sustained".

Any investigation resulting in one or more sustained violations shall be referred to the member's Division Commander (Captain) for consideration of appropriate discipline in accordance with city policy.

1003.11 TIME LIMITS FOR INVESTIGATION OF PERSONNEL COMPLAINTS

Administrative investigations (including dispositions of each allegation and notice of the disciplinary action to be administered, if any exist) shall be completed in accordance with the time limits set forth in the applicable MOU, or City policy for non-represented Department members.

1003.12 COUNSELING AND TRAINING

The role of the first-line supervisor is crucial. A Department member's immediate supervisor has the best opportunity to observe the conduct and appearance of members and to detect when corrective action is warranted.

When appropriate, and in accordance with policy, coaching, and counseling should be considered by supervisors. When a deficiency is noted by the member's supervisor or chain of command, a coaching and counseling session may be a viable option to correct the deficiency. When counseling is used, it should include a personal meeting between the supervisor and member for a discussion of the issue(s) and provide the member with the supervisor's expectation(s) for improvement. At the supervisor's discretion, the counseling may be documented in the department's web-based training system as training.

If at the completion of an investigation, it is determined that additional training is needed, then department members will be responsible for completing the training as assigned.. The supervisor or member of the Training Unit conducting the training is responsible for documenting the training in the department's web-based training system.

Counseling and referrals for training (when not being used in conjunction with disciplinary action) are not considered discipline, and the training entries will not be entered into a department member's Internal Affairs File. Moreover, documented training will not be considered a part of the member's disciplinary history, but may be considered in a progressive discipline process when a member repeatedly fails to meet department expectations.

1003.13 DISCIPLINARY ACTION

The Chief of Police will have the prerogative to make the final determination as to the level of discipline on all investigations resulting in department member discipline.

1003.13.1 CORRECTIVE ACTION AND DISCIPLINARY OPTIONS

The Department utilizes a 3-tiered system of corrective action and discipline. The following options for corrective action and discipline in each tier include, but are not limited to:

Salt Lake City Police Department

SLCPD Policy Manual

SLCPD Policy Manual

Complaints Against Personnel - Internal Investigations

- (a) Tier 1
 - 1. Counseling and/or training.
 - 2. Written warning.
- (b) Tier 2
 - 1. Unpaid suspension of 2 shifts or less.
- (c) Tier 3
 - 1. Unpaid suspension of greater than 3 shifts.
 - 2. Demotion
 - 3. Termination

Unless otherwise governed by an applicable MOU, Tier 1 corrective actions may be used as the basis for progressive discipline.

1003.13.2 FACTORS OF CONSIDERATION IN DISCIPLINE

The following factors shall be considered when a disciplinary decision is being made (*Burgess v. Department of Corrections*, 2017 UT App 186; *Harmon v. Ogden City Civil Service Comm'n*, et al., 2007 UT App 336; *West Valley City v. Coyle*, 2016 UT App 149):

- (a) Whether the employee has an exemplary service record.
- (b) Whether the evidence of misconduct is tenuous.
- (c) Whether the employee has been dishonest.
- (d) Whether there are numerous violations.
- (e) Whether there has been ineffective progressive discipline.
- (f) Whether the violation is directly related to the employee's official duties and significantly impedes his or her ability to carry out those duties.
- (g) Whether the offense was of a type that adversely affects the public confidence in the department.
- (h) Whether the offense undermines the morale and effectiveness of the department.
- (i) Whether the offense was committed willfully or knowingly, rather than negligently or inadvertently.
- (j) Whether the misconduct is likely to reoccur.

1003.13.3 SUSPENSIONS

Suspended Department members will relinquish issued weapons, badges, ID cards, and police vehicle as directed by their Division Commander, or his or her designee. The member will be provided a receipt of these items. The supervisor confiscating the items will be responsible for securing them.

Suspended members will not display any identification indicating they are Department members.

Salt Lake City Police Department

SLCPD Policy Manual

SLCPD Policy Manual

Complaints Against Personnel - Internal Investigations

Suspended police officers will not carry department firearms, display any identification indicating they are police officers, operate any police vehicle, represent themselves as police officers in any situation, or perform any official law enforcement capacity except by court order.

Suspended members are prohibited from working any secondary employment that requires the wearing of a police uniform or the need for police authority.

1003.13.4 INFORMATION FURNISHED UPON TERMINATION

When Department member misconduct results in termination, the following information will be furnished to the terminated member:

- (a) Reason for termination.
- (b) Effective date of termination.
- (c) Status of fringe and retirement benefits after the termination.

A specific reason for termination is not required for entry-level probationary members who are terminated for failing to meet the department's probationary standers.

1003.13.5 APPEAL OF DISCIPLINARY ACTION

Disciplinary action may be appealed as outlined in the applicable MOU, or City policy for non-represented Department members.

1003.13.6 DOCUMENTATION OF DISCIPLINARY ACTION

Disciplinary action will be documented in a department member's personnel file, as well as their Internal Affairs file.

1003.14 WAIVER OF CONTRACTUAL RIGHTS

In cases where a complaint against a department member has been categorized as a Category 2 allegation or an M-File, the member may elect to waive their contractual and/or procedural rights as specified in the applicable MOU, or as outlined in policy, and request an outline of the potential discipline for the alleged misconduct. This may be done whether the investigation is being conducted by the Internal affairs Unit or the member's division.

If the member chooses to waive their contractual and/or procedural rights, the member must document in writing that they accept the discipline without the possibility of appeal. Members opting to waive their contractual and/or procedural rights will still be afforded all rights pertaining to the Garrity rule and may have a representative present during the waiver procedure.

If a Department member elects to waive his or her contractual and/or procedural rights, the Department reserves the right to reopen the matter in the event significant new, or different, information is received.

The option of waiving contractual rights is not available for Category I allegations.

Salt Lake City Police Department

SLCPD Policy Manual

SLCPD Policy Manual

Complaints Against Personnel - Internal Investigations

1003.15 INTERNAL AFFAIRS FILES

In the event that an accused department member (or the representative of such member) knowingly makes false representations regarding any internal investigation, and such false representations are communicated to any media source, the department may disclose sufficient information from the investigation to refute such false representations.

All Internal Affairs files will be retained consistent with City policy, Utah State Law, and Federal Law.

Internal Affairs files shall be maintained under the exclusive control of the Internal Affairs Unit in conjunction with the office of the Chief of Police. Access to these files may only be approved by the Chief of Police or the Internal Affairs Unit Director.

Internal Affairs files shall contain the complete investigation of all complaints of member misconduct, regardless of disposition.

Investigations of complaints categorized as M-Files, complaints resolved in the field by a supervisor, and complaints that result in a "Not Sustained" finding shall not be placed in the member's personnel file, but will be maintained in the Internal Affairs file.

Members may sign a waiver documenting their agreement to allow a representative to view their Internal Affairs file. Such waiver will be put on record in their Internal Affairs file.

1003.16 FALSE COMPLAINTS OF CRIMINAL MISCONDUCT

It is the policy of this Department to recommend criminal charges to the appropriate prosecutorial agency if it can be shown that an individual knowingly made a false complaint of criminal wrongdoing against a member of the Department (Utah Code 76-8-506). This action should be utilized for complaints that do not have a basis in fact, not cases in which there are differing perspectives about the appropriateness of actions taken by an officer.

The Internal Affairs Director is responsible for making the initial determination of whether a false complaint of criminal wrongdoing has been made. In making this determination, the Internal Affairs Director will consider the following:

- (a) Whether any evidence was generated during the investigation that either controverted or supported the complaint.
- (b) Whether there were other witnesses whose statements either controverted or supported the complaint.
- (c) Whether the complainant knew or should have known the complaint was false.
- (d) The complainant's complaint history with the Department.

If the Internal Affairs Director makes the determination that the complaint was false, and meets the requirements of this policy, they shall brief the

Chief of Police and provide the investigative report. If the Chief of Police determines that the complaint was false, and meets the requirements of this policy, the Internal Affairs Unit will refer the case to the appropriate prosecutorial agency for criminal charges.

Salt Lake City Police Department

SLCPD Policy Manual

SLCPD Policy Manual

Complaints Against Personnel - Internal Investigations

1003.17 REVISIONS

Enacted: May 14, 2018

Revised: May 21, 2018

Revised: November 8, 2018

Revised: February 28, 2023

Revised: April 4, 2023

Grievances

1004.1 PURPOSE AND SCOPE

It is the policy of the Department that all grievances be handled quickly and fairly without discrimination against employees who file a grievance. The Department's philosophy is to promote open lines of communication between employees and supervisors.

1004.1.1 GRIEVANCE DEFINED

A grievance is defined in the respective Memorandums of Understanding. Grievances may be brought by an individually affected employee or by a group representative.

1004.2 GRIEVANCE PROCEDURE

All grievances will be processed and handled in accordance with the applicable Memorandum of Understanding and City policy.

1004.3 REVISIONS

Enacted: May 14, 2018

Reporting of Employee Convictions, Charges, Investigations, and Citations

1005.1 PURPOSE AND SCOPE

Convictions of certain offenses may restrict or prohibit an employee's ability to properly perform official duties. The same is true for an employee who is under criminal investigation, arrested, charged, or receives certain types of citations. Therefore, all employees shall be required to promptly notify the Department of any past and/or current criminal convictions, criminal investigations, arrests, criminal charges, and certain citations.

1005.2 DOMESTIC VIOLENCE CONVICTIONS AND RESTRAINING ORDERS

Federal law prohibits individuals convicted of certain offenses and individuals subject to certain court orders from lawfully possessing a firearm. Such convictions and court orders often involve allegations of the use or attempted use of force or threatened use of a weapon on any individual in a domestic relationship (e.g., spouse, cohabitant, parent, child) (18 USC § 922; Utah Code 76-10-503).

All members are responsible for ensuring that they have not been disqualified from possessing a firearm by any such conviction or court order and shall promptly report any such conviction or court order to a supervisor, as provided in this policy.

Any person applying for or holding a concealed firearm permit and who is convicted of any offense involving domestic violence may have the permit refused, revoked or suspended (Utah Code 53-5-704(2)(a)(vi)).

1005.3 FELONY CRIMINAL CONVICTIONS

Utah Code 53-6-203(1)(d) prohibits any person convicted of a felony from being a peace officer in the State of Utah. This prohibition applies regardless of whether the guilt was established by way of a verdict, guilty or nolo contendere plea.

1005.4 OTHER CRIMINAL CONVICTIONS, INVESTIGATIONS, ARRESTS, CHARGES, AND CITATIONS

While legal restrictions may or may not be imposed by statute or by the courts, criminal conduct by members of the Department may be inherently in conflict with law enforcement duties and the public trust. As such, any employee who is/was under criminal investigation, arrested, charged or cited for, or is convicted of any criminal offense (regardless of whether the guilt was established by way of a verdict, guilty or nolo contendere plea) shall promptly report any such actions, as provided in this policy.

1005.4.1 TRAFFIC

Any employee who operates a City vehicle and has their driver license suspended or revoked must notify the Department as soon as practicable.

Salt Lake City Police Department

SLCPD Policy Manual

SLCPD Policy Manual

Reporting of Employee Convictions, Charges, Investigations, and Citations

This policy does not apply to traffic citations except for charges of driving under the influence, reckless driving, and hit and run.

1005.5 REPORTING PROCEDURE

All members of this department and all retired officers with an identification card issued by the Department shall promptly notify their immediate supervisor (or the Office of the Chief of Police in the case of retired officers) verbally and in writing of any past criminal conviction, investigation, arrest, charging, or applicable citation, regardless of whether the matter is currently on appeal and regardless of the penalty or sentence, if any.

All members and all retired officers with an identification card issued by the Department shall further promptly notify their immediate supervisor (or the Office of the Chief of Police in the case of retired officers) verbally and in writing if the member or retiree becomes the subject of a domestic violence restraining order or similar court order.

All members of this department and all retired officers with an identification card issued by the Department shall promptly notify the on-duty Watch Commander verbally and in writing of any arrest, notification of criminal investigation or charging, or applicable citation.

A supervisor notified of any of the above listed situations shall forward the notification up the notifying employee's chain of command and will make any required Blue Team entries pursuant to the Complaints against Personnel and Disciplinary Action Policy.

Any member whose criminal conviction, investigation, arrest, charging, or citation unduly restricts or prohibits that member from fully and properly performing his/her duties may be disciplined including, but not limited to, being placed on administrative leave, reassignment and/or termination.

Any member failing to provide prompt written notice pursuant to this policy shall be subject to discipline.

1005.6 REVISIONS

Enacted: May 14, 2018

Drug- and Alcohol-Free Workplace

1006.1 PURPOSE AND SCOPE

The purpose of this policy is to establish clear and uniform guidelines regarding drugs and alcohol in the workplace, as well as random drug testing.

1006.1.1 DEFINITIONS

Controlled Substance – Any drug listed in 21 U.S.C. 812 and other federal regulations, and Utah State Code 58-37-4.

Drug – Any substance, including alcohol, which is restricted or prohibited by this policy.

Drug Test – A requirement by an employee to submit a sample of urine or breath in accordance with Department procedures to detect prohibited controlled substance or alcohol use.

Designated Employee Representative (DER) – The designated City Human Resources representative that coordinates random drug testing for the City.

Dilute Specimen – A urine specimen in which the creatinine concentration is equal to or greater than 2 mg/dL, but less than or equal to 5mg/dL.

Medical Review Officer (MRO) – A licensed physician responsible for receiving laboratory results generated by the Department's drug testing program.

Metabolite – A compound produced from chemical changes of a drug in the body.

Negative Test Result – The results of a confirmatory test conducted and reported (in writing) by a laboratory indicating that drugs or their metabolites are not present in a concentration above the established cut-off level.

Positive Test Result – The results of a confirmatory test conducted and reported (in writing) by a laboratory indicating that drugs or their metabolites are present in a concentration above the established cut-off level.

Random Selection – A method of selection in which every employee has an equal chance to be selected each and every time a selection is conducted.

Reasonable Suspicion – Specific and articulable facts known to a supervisor which, taken together with rational inferences, warrant a conclusion by the supervisor that the employee may be in violation of the requirements of this policy. Reasonable suspicion is less than probable cause, but can never be based on inarticulate hunches or feelings.

1006.2 POLICY

It is the policy of this Department to provide a drug-free workplace for all members. The unauthorized or unlawful manufacture, distribution, dispensation, possession, or use of a controlled substance or alcohol by any employee at any workplace or in any vehicle used for official purposes is strictly prohibited. This prohibition expressly applies during the conducting of official business in City owned or leased facilities, while in uniform on- or off-duty, when operating

Salt Lake City Police Department

SLCPD Policy Manual

SLCPD Policy Manual

Drug- and Alcohol-Free Workplace

City owned or leased vehicles, or when using personally owned vehicles when on Department business.

Employees shall not report for duty under the influence of any measurable amount of alcohol. The use of controlled substances is prohibited, on- and off-duty. The use of prescribed drugs and over-the-counter remedies is permitted provided it does not impair an employee's ability to perform the essential functions of the job effectively and in a safe manner, and does not endanger other individuals.

Any employee of the Department that engages in the unauthorized use of controlled substances undermines the integrity of the Department and compromises public safety. Therefore, it is the policy of this Department to maintain a drug-free workplace, in part, through the use of random employee drug testing.

Violation of this policy may be grounds for discipline up to and including termination.

1006.3 EMPLOYEE RESPONSIBILITIES

Employees shall notify their supervisor immediately if they observe behavior or other evidence that they believe demonstrates that a fellow employee poses a risk to the health and safety of the employee or others due to drug use.

Employees shall not knowingly associate with persons who unlawfully possess or distribute drugs, except as it relates to the officer's duties.

Employees aware of the abuse, unlawful use, sale, or distribution of drugs are obligated to bring the facts relating to such activities to the attention of the Department, or local jurisdiction if off-duty or outside the corporate limits of the City at the time.

Any employee arrested for violating any criminal controlled substance or alcohol statute or ordinance will notify the on-duty Watch Commander as soon as possible.

Any employee who unintentionally ingests, or is made to ingest, a controlled substance shall immediately report the incident to their supervisor so that the appropriate medical steps may be taken to ensure the employee's health and safety.

Employees shall notify their supervisor when required to use prescription medicine which they have been informed has a potential to impair job performance.

- (a) The employee shall advise the supervisor of the known side-effects of such medication and the prescribed period of use.

Employees are encouraged to seek voluntary treatment for drug abuse problems. Treatment programs will be at the employee's expense and may be covered by the employee's health insurance. The City also provides an Employee Assistance Program that may be able to assist in these matters (see the Peer Support and other Employee Programs Policy).

Salt Lake City Police Department

SLCPD Policy Manual

SLCPD Policy Manual

Drug- and Alcohol-Free Workplace

1006.3.1 EXCEPTIONS BY ASSIGNMENT

Employees who are authorized to consume alcohol as part of a special assignment shall not do so to the extent of impairing on-duty performance. A supervisor will determine any exception. The supervisor will be responsible for the employee's safety and transportation under such circumstances.

Employees may possess and transport drugs if such material holds evidentiary value, or needs to be disposed of, and it is the employee's responsibility to do so.

Employees, while in the performance of their duties, and while acting under proper and specific orders from a supervisor, may possess or dispense certain authorized controlled substances in connection with and in furtherance of an investigation (i.e., narcotic detectives).

1006.4 APPLICANT DRUG TESTING

All candidates for employment with the Department shall be required to take a drug test as a condition of continued employment consideration. They will be notified of such in writing.

The test will be administered on the basis of a conditional offer of employment.

Applicants shall be disqualified from further consideration for employment should they refuse to submit to a required drug test or fail a drug test.

1006.5 EMPLOYEE RANDOM DRUG TESTING

All employees of the Department are subject to random drug testing for controlled substances. Because the selection is random, some employees may be selected more than once during a year's time.

The Department will conduct random drug testing at a minimum annual rate of 15% of its employees.

Refer to the Drug and Alcohol Testing Procedure for details on testing methods and obtaining test results.

1006.6 REASONABLE SUSPICION TESTING

The Department may require controlled substance and/or alcohol testing of an employee if reasonable suspicion exists that the employee is impaired by drugs. A determination of reasonable suspicion must be based on specific observations concerning the appearance, performance, behavior, speech, or body odors of the employee.

Refer to the Drug and Alcohol Testing Procedure for details on testing methods and obtaining test results.

1006.7 CONFIDENTIALITY

All information, interviews, reports, statements, memoranda, or test results received by the City and Department through drug testing are confidential communications and will be processed on a need-to-know basis. They will only be used in a proceeding related to an action taken by the Department or the City, or in defense of any action brought against the Department or the City.

Salt Lake City Police Department

SLCPD Policy Manual

SLCPD Policy Manual

Drug- and Alcohol-Free Workplace

1006.8 REVISIONS

Enacted: May 14, 2018

Smoking and Tobacco Use

1007.1 PURPOSE AND SCOPE

This policy establishes limitations on smoking and the use of tobacco products by members and others while on-duty or while in Salt Lake City Police Department facilities or vehicles.

For the purposes of this policy, smoking and tobacco use includes, but is not limited to, any tobacco product, such as cigarettes, cigars, pipe tobacco, snuff, tobacco pouches and chewing tobacco, as well as any device intended to simulate smoking, such as an electronic cigarette or personal vaporizer.

1007.2 POLICY

The Salt Lake City Police Department recognizes that tobacco use is a health risk and can be offensive to others. Smoking and tobacco use also presents an unprofessional image for the Department and its members. Therefore smoking and tobacco use is prohibited by members and visitors in all department facilities, building and vehicles, and as is further outlined in this policy (Utah Code 26-38-3).

1007.3 SMOKING AND TOBACCO USE

Smoking and tobacco use by members is prohibited anytime members are in public view representing the Salt Lake City Police Department.

It shall be the responsibility of each member to ensure that no person under his/her supervision smokes or uses any tobacco product inside City facilities, buildings and vehicles.

1007.4 ADDITIONAL PROHIBITIONS

No person shall smoke tobacco products within 25 feet of any entrance way, exit or operable window of any public building (including any department facility), all enclosed indoor places of public access, or in any buildings where restrictions on use of tobacco products are posted or provided by other means, whether the person is present for training, enforcement or any other purpose (UAC R392-510-9).

1007.5 REVISIONS

Enacted: May 14, 2018

Leave Time

1008.1 PURPOSE AND SCOPE

This policy provides general guidance regarding the use and processing of vacation leave, holiday leave, personal leave, and sick leave.

This policy is not intended to cover all types of sick or other leaves. For example, employees may be entitled to additional paid or unpaid leave for certain family and medical reasons as provided for in the Family and Medical Leave Act (FMLA) (29 USC § 2601 et seq.), as outlined in City policy.

1008.2 POLICY

It is the policy of the Salt Lake City Police Department to provide eligible employees with vacation leave, holiday leave, personal leave, and/or sick leave. All leave accrual and terms of use will be in accordance with City policy, the applicable Memorandum of Understanding, and compensation plan.

1008.2.1 UNSCHEDULED LEAVE

Generally, requests for unscheduled leave made by a friend or relative will not result in authorized leave, unless the employee is unable to make the request due to circumstances beyond his or her control.

Telephone answering machine or email messages, or messages transmitted to secretaries, dispatchers, co-workers, or others, are generally not acceptable for approval. Employees must speak directly with their immediate supervisor or other designated supervisor.

1008.3 EXTENDED VACATION (SABBATICAL) REQUESTS

Extended leave use is determined to be any consecutive days off in excess of 120 working hours. The time will not be allowed until processed and approved by the division commander. The office technician inputting the leave request will notify the division commander of the affected employee's extended leave request before adding it to the timekeeping system.

Requests outside of the annual leave request time frame must be submitted in writing to the employee's immediate supervisor to be forwarded to the division commander for review. All requests will be considered on a case-by-case basis, balancing the needs of the Department with the employee's requests and requests of coworkers. The division commander will notify the employee and timekeeper as soon as possible after the request has been approved or denied.

1008.4 LEAVE ABUSE

Employees are responsible to know and plan their use of leave time. Uncompensated time off must have prior approval from the Chief of Police or designee. No additional approval is necessary in instances where the start of a new trimester schedule occurs and an employee changes shifts and subsequently creates an excess or shortage of hours in the first working week.

Leave abuse characteristically involves one or more of the following:

Salt Lake City Police Department

SLCPD Policy Manual

SLCPD Policy Manual

Leave Time

- (a) Repeatedly failing to meet the expectation of being at work, on time, when scheduled to work.
- (b) Frequently calling in sick on the first or last day of the work week, creating a “Monday-Friday” absence pattern.
- (c) Exhausting leave balances and requesting unpaid absence not covered by the Family and Medical Leave Act or the Americans with Disabilities Act.
- (d) Without permission, arriving late to work or leaving work early.
- (e) Failing to properly notify the supervisor prior to an absence.

Leave abuse will be addressed with appropriate progressive non-disciplinary and disciplinary intervention, in accordance with the Complaints Against Personnel and Disciplinary Action Policy.

1008.5 REVISIONS

Enacted: May 14, 2018

Revised: March 6, 2020

Revised: June 30, 2022

Seat Belts

1009.1 PURPOSE AND SCOPE

This policy establishes guidelines for the use of seat belts and child restraints. This policy will apply to all members operating or riding in department vehicles.

1009.1.1 DEFINITIONS

Definitions related to this policy include:

Child restraint system - An infant or child passenger restraint system that meets Federal Motor Vehicle Safety Standards (FMVSS) and Regulations set forth in 49 CFR 571.213 (Utah Code 41-6a-1601).

1009.2 POLICY

It is the policy of the Salt Lake City Police Department that members use safety and child restraint systems to reduce the possibility of death or injury in a motor vehicle collision.

1009.3 WEARING OF SAFETY RESTRAINTS

All members shall wear properly adjusted safety restraints when operating or riding in a seat equipped with restraints, in any vehicle owned, leased or rented by this department, while on- or off-duty, or in any privately owned vehicle while on-duty. The member driving such a vehicle shall ensure that all other occupants, including non-members of the Department, are properly restrained (Utah Code 41-6a-1803).

Exceptions to the requirement to wear safety restraints may be made only in exceptional situations where, due to unusual circumstances, wearing a seat belt would endanger the department member or the public. Members must be prepared to justify any deviation from this requirement.

1009.4 TRANSPORTING CHILDREN

A child younger than 8 years of age shall be secured using a child restraint system in the manner prescribed by the manufacturer of the system unless an exemption exists due to the child's height (57 inches tall or taller) (Utah Code 41-6a-1803).

Rear seat passengers in a cage-equipped vehicle may have reduced clearance, which requires careful seating and positioning of seat belts. Due to this reduced clearance, and if permitted by law, children and any child restraint system may be secured in the front seat of such vehicles provided this positioning meets federal safety standards and the vehicle and child restraint system manufacturer's design and use recommendations. In the event that a child is transported in the front seat of a vehicle, the seat should be pushed back as far as possible and the passenger-side airbag should be deactivated. If this is not possible, members should arrange alternate transportation when feasible.

1009.5 TRANSPORTING SUSPECTS, PRISONERS OR ARRESTEES

Suspects, prisoners, and arrestees should be in a seated position and secured in the rear seat of any department vehicle with a cage.

Salt Lake City Police Department

SLCPD Policy Manual

SLCPD Policy Manual

Seat Belts

If a suspect, prisoner, or arrestee is being transported in a vehicle without a cage, the individual will be seated in the front passenger seat. Whenever possible, a second officer should assist with the transport and be seated in the rear passenger seat.

All suspects, prisoners, and arrestees will be secured by seat belts provided by the vehicle manufacturer. Seat belts are not intended to be a substitute for handcuffs or other appendage restraints.

Prisoners in leg restraints shall be transported in accordance with the Handcuffing and Restraints Policy.

1009.6 INOPERABLE SEAT BELTS

Department vehicles shall not be operated when the seat belt in the driver's position is inoperable. Persons shall not be transported in a seat in which the seat belt is inoperable.

Department vehicle seat belts shall not be modified, removed, deactivated or altered in any way, except by the vehicle maintenance and repair staff, who shall do so only with the express authorization of the Chief of Police.

Members who discover an inoperable restraint system shall report the defect to the appropriate supervisor. Prompt action will be taken to replace or repair the system.

1009.7 VEHICLES MANUFACTURED WITHOUT SEAT BELTS

Vehicles manufactured and certified for use without seat belts or other restraint systems are subject to the manufacturer's operator requirements for safe use.

1009.8 VEHICLE AIRBAGS

In all vehicles equipped with airbag restraint systems, the system will not be tampered with or deactivated, except when transporting children as written elsewhere in this policy. All equipment installed in vehicles equipped with airbags will be installed as per the vehicle manufacturer specifications to avoid the danger of interfering with the effective deployment of the airbag device.

1009.9 REVISIONS

Enacted: May 14, 2018

Body Armor

1010.1 PURPOSE AND SCOPE

The purpose of this policy is to provide law enforcement officers with guidelines for the proper use of body armor.

1010.2 POLICY

It is the policy of the Salt Lake City Police Department to maximize officer safety through the use of body armor in combination with prescribed safety procedures. While body armor provides a significant level of protection, it is not a substitute for the observance of officer safety procedures.

1010.3 ISSUANCE OF BODY ARMOR

The Quartermaster supervisor shall ensure that body armor is issued to all officers when the officer begins service at the Salt Lake City Police Department and that, when issued, the body armor meets or exceeds the standards of the National Institute of Justice. Issued vests will be fitted to each officer by the vendor. Officers may, at their own expense, purchase and wear other armor meeting or exceeding Department standards with approval of the Training Unit.

The Quartermaster supervisor shall establish a body armor replacement schedule and ensure that replacement body armor is issued pursuant to the schedule or whenever the body armor becomes worn or damaged to the point that its effectiveness or functionality has been compromised. Manufacturer expiration dates will be observed and replacement issued prior to any such expiration.

1010.3.1 USE OF SOFT BODY ARMOR

Generally, the use of body armor is required subject to the following:

- (a) Officers shall only wear agency-approved body armor.
- (b) Officers shall wear body armor anytime they are in a situation where they could reasonably be expected to take enforcement action.
- (c) Officers may be excused from wearing body armor when they are functioning primarily in an administrative or support capacity and could not reasonably be expected to take enforcement action.
- (d) Officers not required to wear body armor during their tour of duty will have it readily available.
- (e) An officer may be excused from wearing body armor when he/she is involved in undercover or plainclothes work that his/her supervisor determines could be compromised by wearing body armor, or when a supervisor determines that other circumstances make it inappropriate to mandate wearing body armor.
- (f) All officers working uniformed secondary employment or special event posts must wear protective vests, unless otherwise authorized by the Secondary Employment Lieutenant.

Salt Lake City Police Department

SLCPD Policy Manual

SLCPD Policy Manual

Body Armor

1010.3.2 INSPECTIONS OF BODY ARMOR

Supervisors should ensure that body armor is worn and maintained in accordance with this policy through routine observation and periodic inspections.

1010.3.3 CARE AND MAINTENANCE OF SOFT BODY ARMOR

Soft body armor should be cared for and cleaned pursuant to the manufacturer's care instructions provided with the soft body armor. The instructions can be found on labels located on the external surface of each ballistic panel. The carrier should also have a label that contains care instructions. Failure to follow these instructions may damage the ballistic performance capabilities of the armor. If care instructions for the soft body armor cannot be located, contact the manufacturer to request care instructions.

Soft body armor should not be exposed to any cleaning agents or methods not specifically recommended by the manufacturer, as noted on the armor panel label.

1010.4 TRAINING UNIT RESPONSIBILITIES

The Training Unit should:

- (a) Monitor technological advances in the body armor industry for any appropriate changes to Department approved body armor.
- (b) Assess weapons and ammunition currently in use and the suitability of approved body armor to protect against those threats.
- (c) Provide training that educates officers about the safety benefits of wearing body armor.

1010.5 REVISIONS

Enacted: May 14, 2018

Personnel Records

1011.1 PURPOSE AND SCOPE

This policy governs maintenance and access to personnel records.

1011.2 POLICY

It is the policy of this department to maintain personnel records and preserve the confidentiality of personnel records pursuant to the Constitution and the laws of Utah (Utah Code 63G-2-302 et seq.).

The official copy of all personnel files for Department employees are maintained in a secure, centralized location under the control and maintenance of the Division of Human Resources.

1011.3 PERSONNEL FILE

The official personnel file maintained in Human Resources may be hard copy or electronic and may include offer letters, appointment letters, formal disciplinary action, changes in pay, change in position, performance evaluations, commendations and awards, etc.

1011.3.1 BENEFITS FILE

The benefits records file is a separate personnel file and contains an employee's benefits enrollment records.

1011.3.2 MEDICAL FILE

The medical records file is a separate personnel file, maintained separately from all other personnel records, and contains an employee's FMLA paperwork, notes from medical providers, documentation related to Workers' Compensation injuries, documentation regarding business adjustments, modified duty accommodations under the ADA, etc.

1011.3.3 ENTRIES INTO PERSONNEL FILE

A document adverse to an employee's employment may not be entered in their personnel file (excluding Internal Affairs file) without the employee having first read and signed the document.

The entry may be made, if after reading the document, the employee refuses to sign it. The employee's refusal to sign shall be noted in the document. An employee has fourteen (14) calendar days within which to file a written response to any adverse document entered in their personnel file. The written response shall be attached to and accompany the adverse document.

1011.4 TRAINING FILE

An individual training file shall be maintained by the Training Unit for each officer. Unit Directors and/or supervisors over non-sworn members are responsible for maintaining necessary training files for the members under their command.

Training files will contain records of all training, original or photocopies of available certificates, transcripts, diplomas, and other documentation. Training records may also be created and stored remotely, either manually or automatically.

Salt Lake City Police Department

SLCPD Policy Manual

SLCPD Policy Manual

Personnel Records

- (a) The involved member is responsible for providing the Training Unit or Director/supervisor (whichever is applicable) with evidence of completed training/education in a timely manner.
- (b) The Training Unit or Director/supervisor shall ensure that copies of such training records are placed in the member's training file.

1011.5 INTERNAL AFFAIRS FILE

Internal Affairs files shall be maintained under the exclusive control of the Internal Affairs Unit in conjunction with the office of the Chief of Police. Access to these files may only be approved by the Chief of Police or the Internal Affairs Unit supervisor.

These files shall contain the complete investigation of all formal complaints of member misconduct, regardless of disposition. Investigations of complaints that result in "Not Sustained" findings shall not be placed in the member's personnel file but will be maintained in the internal affairs file.

1011.5.1 ACCESS TO INTERNAL AFFAIRS FILE

Members shall, upon reasonable notice, be provided access to their individual Internal Affairs files for review.

Additionally, members may sign a waiver documenting their agreement to allow another party to view their Internal Affairs file. Such waiver will be put on record in their Internal Affairs file.

1011.6 SECURITY

Personnel records should be maintained in a secured location and locked either in a cabinet or access-controlled room. Personnel records maintained in an electronic format should have adequate password protection.

Personnel records are subject to disclosure only as provided in this policy, the Records Maintenance and Release Policy or according to applicable discovery procedures.

Access to the official personnel file maintained by human resources will be limited to the following:

- (a) Human resources staff.
- (b) The employee, active or terminated, who is the subject of the file.
- (c) A person acting under the employee's power of attorney or with a signed release from the employee.
- (d) A union representative when human resources has written consent from the employee.
- (e) Government entities requiring information as part of an investigation, audit, or similar need.
- (f) Supervisory personnel overseeing an employee's hiring or current job tasks.
- (g) The City Attorney's Office.
- (h) To comply with any legal requirements.

Salt Lake City Police Department

SLCPD Policy Manual

SLCPD Policy Manual

Personnel Records

1011.6.1 RELEASE OF PERSONNEL INFORMATION

Information such as the member's medical information, or the home address, telephone number and Social Security number of the member or of the member's family, that is contained in a personnel record is confidential and may not be released (Utah Code 63G-2-302; Utah Code 63G-2-303; Utah Code 63G-2-304).

Additionally, the Chief of Police or the authorized designee shall provide officers with a form to request that an officer's, or the officer's immediate family members', private information be removed or concealed from state or local government agencies' publicly accessible websites and databases (Utah Code 53-18-102; Utah Code 53-18-103).

The Department may release any factual information concerning a disciplinary investigation if the member who is the subject of the investigation (or the member's representative) publicly makes a statement that is published in the media and that the member (or representative) knows to be false. The disclosure of such information, if any, shall be limited to facts that refute any such false statement.

1011.7 RETENTION AND PURGING

Unless provided otherwise in this policy, personnel records shall be maintained in accordance with the established records retention schedule.

1011.8 REVISIONS

Enacted: May 14, 2018

Revised: December 17, 2018

Commendations and Awards

1012.1 PURPOSE AND SCOPE

This policy provides general guidelines for recognizing commendable or meritorious acts of members of the Salt Lake City Police Department and individuals from the community.

1012.2 POLICY

It is the policy of the Salt Lake City Police Department to recognize and acknowledge exceptional individual or group achievements, performance, proficiency, heroism and service of its members and individuals from the community through commendations and awards.

1012.3 COMMENDATIONS

Commendations for members of the Department or for individuals from the community may be initiated by any department member or by any person from the community.

Minor meritorious acts, such as an employee's superior handling of a difficult situation, will be acknowledged by a letter of commendation. Major meritorious acts involving commendatory bravery shall be acknowledged by a Departmental medal or unit citation.

1012.4 CRITERIA

A meritorious or commendable act may include, but is not limited to:

- Superior handling of a difficult situation.
- Conspicuous bravery or outstanding performance.
- Any action or performance that is above and beyond typical duties.

1012.5 AWARDS

Awards may be bestowed upon members of the Department and individuals from the community. These awards include:

- **Medal of Valor** - May be awarded to employees who distinguish themselves by performing courageous acts above-and-beyond the call of duty, and involving risk or imminent danger to their lives. Such acts must have been performed for the purpose of saving or protecting human life. Employees must perform acts so outstanding that it clearly distinguishes their courage from other forms of recognized bravery. There must be no margin of doubt or possibility of error in awarding this honor.
- **Ultimate Service Award** - May be given in cases where an employee dies while on duty or while rendering direct service to the citizens of Salt Lake City under conditions that do not meet the guidelines set forth in the Medal of Valor Award.
- **Lifesaving Award** - May be given in cases where an employee's actions directly result in a life being saved.
- **Purple Heart** - May be awarded to any sworn member who in the necessary performance of law enforcement functions, on- or off-duty, receives serious bodily injury; or posthumously to the next of kin in the name of those who are killed or die

Salt Lake City Police Department

SLCPD Policy Manual

SLCPD Policy Manual

Commendations and Awards

of wounds received in the line of duty. This award does not include injury in motor vehicle accidents unless special circumstances are determined to exist by the awards committee. The injury must not be the result of the employee's own negligence.

- **Police Medal** - May be awarded to the employees who in the line of police duty, distinguish themselves by performing courageous acts involving risk of imminent serious personal injury for the purpose of saving or protecting human life; or, in the course of an extended investigation, demanding continuous exposure to grave personal hazard, and willingly accept such risk in the service of the Department; or, for extraordinarily credible and unusual police accomplishments.
- **Police Star** - May be awarded to employees who, in the line of police duty, distinguish themselves by performing courageous acts involving personal hazard in protecting or saving human life; or similar acts necessary to effect an arrest to prevent the escape of a person who committed an act which seriously exposed any person to death or serious personal injury. Furthermore, the Police Star may be awarded to employees of the Department for performing highly credible and unusual police accomplishments.
- **Police Distinguished Service Medal** - This medal is the Department's highest award for service and may be awarded to employees who distinguish themselves by performing exceptional service in a duty of great responsibility or of critical importance to law enforcement.
- **Police Meritorious Service Medal** - May be awarded to employees who perform meritorious service similar to, but to a lesser degree than, that required for the Police Distinguished Service Medal.
- **Gold Star** - Awarded to a Sergeant or above when they have received a multiple of the same award - may be worn on the original medal.
- **Nickel Star** - Awarded to an Officer when they have received a multiple of the same award - may be worn on the original medal.
- **Police Distinguished Unit Citation** - This citation is the Department's highest unit award and may be awarded to an organizational unit of the Department for bravery or outstanding service by its employees functioning as a team.
- **Police Meritorious Unit Citation** - May be awarded to an organizational unit of the Department for bravery or outstanding service, but to a lesser degree than, that required for the Police Department Unit Citation.
- **Public Service Medal of Valor** - May be awarded to citizens who give their lives in service to the community or distinguish themselves by performing courageous acts beyond the call of civic duty and involving risk or imminent danger to their lives. Furthermore, such acts must have been performed for the purpose of saving or protecting human life. Citizens must perform acts so outstanding that it clearly distinguished their courage from other forms of recognized bravery. There must be no margin of doubt or possibility of error in awarding this honor.
- **Public Service Star** - May be awarded to citizens who distinguish themselves by performing courageous acts involving personal hazard in protecting or saving human life, or similar acts necessary to effect the arrest or prevent the escape of a person who committed an act which seriously exposed any person to death or serious injury.

Salt Lake City Police Department

SLCPD Policy Manual

SLCPD Policy Manual

Commendations and Awards

- **Partner in Public Safety** - May be awarded to a member of the community who aided Police Department members or rendered meritorious service to community law enforcement efforts.
- **Police Outstanding Tactics Award** - May be awarded to employees who, in the line of police duty, utilize exceptional tactical skills, communication, and/or other techniques to successfully resolve a situation that could have resulted in the use of deadly force. This award will be presented monthly to employees that meet the above criteria and will be recognized at the annual Awards Gala.
- **Civilian Humanitarian Service Award** - This medal is awarded for direct "hands-on" participation in an act or operation of a humanitarian nature directed toward an individual or group of individuals while at work or outside of work.
- **Civilian Service Award** - This medal is the Department's highest award for service and may be awarded to employees who distinguish themselves by performing exceptional service in a duty of great responsibility or of critical importance to law enforcement.
- **Civilian Unit Award** - This citation is the Department's highest civilian unit award and may be awarded to a civilian organizational unit of the Department for bravery or outstanding service by its employees functioning as a team.
- **Chief Awards** - The Chief awards the Civilian of the Year, Officer of the Year, and Unit of the Year awards annually.

Criteria for each award and the selection, presentation, and display of any award are determined by the Chief of Police.

1012.6 PROCESSING DOCUMENTATION

[Salt Lake City Police Department Procedure Manual: 1003.2 LETTER OF COMMENDATION - PROCEDURE](#)

[Salt Lake City Police Department Procedure Manual: 1003.3 DEPARTMENTAL MEDAL/UNIT CITATION - PROCEDURE](#)

1012.7 REVISIONS

Enacted: May 14, 2018

Revised: May 21, 2018

Meal Periods and Breaks

1014.1 PURPOSE AND SCOPE

All meal periods and breaks will be governed in accordance with the applicable Memorandum of Understanding, compensation plan, and City policy.

1014.2 REVISIONS

Enacted: May 14, 2018

Lactation Breaks

1015.1 PURPOSE AND SCOPE

The purpose of this policy is to provide reasonable accommodations to employees desiring to express breast milk for the employee's infant child.

1015.2 POLICY

It is the policy of this department to provide, in compliance with the Fair Labor Standards Act, reasonable break time and appropriate facilities to accommodate any employee desiring to express breast milk for her infant nursing child for up to one year after the child's birth (29 USC § 207).

1015.3 LACTATION BREAK TIME

A rest period should be permitted each time the employee has the need to express breast milk (29 USC § 207).

Lactation breaks, if feasible, should be taken at the same time as the employee's regularly scheduled rest or meal periods.

While a reasonable effort will be made to provide additional time beyond authorized breaks, any such time exceeding the regularly scheduled break time may be unpaid.

Employees desiring to take a lactation break should notify Dispatch or a supervisor prior to taking such a break. The employee need not indicate to Dispatch that their busy status is for a lactation break. Such breaks may be reasonably delayed if it would seriously disrupt Department operations.

Lactation breaks should not be interrupted except for emergency or exigent circumstances.

1015.3.1 PRESENCE OF CHILDREN

The Department is not required to allow the child of the employee to be present at the Department for purposes of accommodating breastfeeding (Utah Code 34A-5-106).

1015.4 PRIVATE LOCATION

The Department will make reasonable efforts to accommodate employees with the use of an appropriate room or other location to express milk in private. Such room or place should be in close proximity to the employee's work area and shall be other than a bathroom or toilet stall. The location must be shielded from view and free from intrusion from co-workers and the public (29 USC § 207). The room that may be utilized at the Public Safety Building is Room 3641, which is located on the third floor. The door to the room is clearly marked as a Mother's Room. The Mother's Room at Pioneer Precinct is located across the hall from the line-up room. The door is clearly marked as a Mother's room. Both rooms are to remain locked and can only be accessed with a key obtained through the quartermaster after filling out the [Mothers Room Key Form](#). The form can also be found on the P: drive in the 'Mother's Room' folder. An employee needing to utilize the Mother's Room must complete the Mother's Room Key Form and submit it to the quartermaster.

Salt Lake City Police Department

SLCPD Policy Manual

SLCPD Policy Manual

Lactation Breaks

Upon receipt of the form, the employee will be issued a key that will be assigned to their inventory until it is returned.

Employees occupying the Mother's Room will make it clear to others that the area is occupied by utilizing the slider on the outside of the room. All other employees should avoid interrupting an employee during a lactation break, except to announce an emergency or other urgent circumstance.

Lactation breaks for employees assigned to the field may be taken at the nearest appropriate private area.

1015.5 STORAGE OF EXPRESSED MILK

Any employee storing expressed milk in any authorized refrigerated area within the Department shall clearly label it as such and shall remove it when the employee ends her shift.

1015.6 REVISIONS

Enacted: May 14, 2018

Revised: April 12, 2022

Overtime Compensation Requests

1017.1 PURPOSE AND SCOPE

It is the policy of the Department to compensate non-exempt salaried employees who work authorized overtime either by payment of wages, or by the allowance of accrual of compensatory time off, as agreed and in effect through the applicable Memorandum of Understanding, compensation plan, and City policy. In order to qualify for either, the employee must complete an overtime request entry on Telestaff on the day the overtime is worked.

1017.2 OVERTIME APPROVAL

An employee must have prior approval from a supervisor to perform work in excess of 40 hours per week.

An officer who responds to dispatched calls or on-views an incident while off-duty must receive prior approval from the on-duty Watch Commander or designee, when practicable, to perform work in excess of 15 minutes duration.

1017.3 OVERTIME DISTRIBUTION

When overtime work is available for special events, or to meet Department needs, a Division Commander or their designee may post a schedule for projected overtime assignments and hours.

1017.3.1 PRESCHEDULED OVERTIME ASSIGNMENTS

Officers below the rank of Sergeant have the first opportunity to fill the available pre-scheduled assignments (parade routes, hospital guard duty, etc.). Any assignments not filled 72 hours prior to the sign-up deadline may be offered to officers of the rank of Sergeant. Officers above the rank of Sergeant are not eligible for such assignments.

1017.3.2 CALL OUT AND STANDBY PAY

Call out and standby pay will be compensated as agreed and in effect through the applicable Memorandum of Understanding, compensation plan, and City policy.

1017.3.3 SPECIALIZED ASSIGNMENTS

Specialized overtime assignments for sworn personnel shall be open only to specified employees. For example, only motor officers are eligible to work Motor Squad assignments.

1017.3.4 CIVILIAN PERSONNEL

Overtime assignments for Civilian personnel shall be filled in the manner described in the applicable Memorandum of Understanding, compensation plan, and City policy.

1017.4 OVERTIME PAYMENT PROCESSING

An employee eligible for overtime compensation must create an overtime request entry on TeleStaff by labeling the entry as overtime in the work code field. The employee must also include the actual time worked (beginning and ending), the applicable project code, and an explanation for the type of work completed in the section marked "note." When the entry is complete the employee

Salt Lake City Police Department

SLCPD Policy Manual

SLCPD Policy Manual

Overtime Compensation Requests

will submit the overtime request entry to their supervisor for approval. Supervisors will review and either approve or deny overtime requests based on the circumstances surrounding the request and the requirements present in the applicable Memorandum of Understanding.

1017.5 REVISIONS

Enacted: May 14, 2018

Revised: March 6 2020

Communicable Diseases

1018.1 PURPOSE AND SCOPE

This policy provides general guidelines to assist in minimizing the risk of department members contracting and/or spreading communicable diseases.

1018.1.1 DEFINITIONS

Definitions related to this policy include:

Communicable disease - A human disease caused by microorganisms that are present in and transmissible through human blood, bodily fluid, tissue, or by breathing or coughing. These diseases commonly include, but are not limited to, hepatitis B virus (HBV), HIV and tuberculosis.

Exposure - When an eye, mouth, mucous membrane or non-intact skin comes into contact with blood or other potentially infectious materials, or when these substances are injected or infused under the skin; when an individual is exposed to a person who has a disease that can be passed through the air by talking, sneezing or coughing (e.g., tuberculosis), or the individual is in an area that was occupied by such a person. Exposure only includes those instances that occur due to a member's position at the Salt Lake City Police Department.

1018.2 POLICY

The Salt Lake City Police Department is committed to providing a safe work environment for its members. Members should be aware that they are ultimately responsible for their own health and safety.

1018.3 EXPOSURE CONTROL OFFICER

The Chief of Police will assign a person as the Exposure Control Officer (ECO). The ECO shall develop an exposure control plan that includes:

- (a) Exposure-prevention and decontamination procedures.
- (b) Procedures for when and how to obtain medical attention in the event of an exposure or suspected exposure.
- (c) The provision that department members will have no-cost access to the appropriate personal protective equipment (PPE) for each member's position and risk of exposure.
- (d) Evaluation of persons in custody for any exposure risk and measures to separate them.
- (e) Compliance with all relevant laws or regulations related to communicable diseases, including:
 1. The mandates of the Utah Occupational Safety and Health Act (Utah Code 34A-6-102 et seq.; UAC R614-1 et seq.).
 2. Reporting known or suspected cases of communicable diseases to the local health department (Utah Code 26-6-6; UAC R386-702-4).

Salt Lake City Police Department

SLCPD Policy Manual

SLCPD Policy Manual

Communicable Diseases

3. Responding to requests and notifications regarding exposures covered under the Ryan White law (42 USC § 300ff-133; 42 USC § 300ff-136).
4. Exposure control mandates in 29 CFR 1910.1030 (UAC R614-1-4).

The ECO should also act as the liaison with the Utah Division of Occupational Safety and Health (Utah OSHA). The ECO should annually review and update the exposure control plan and review implementation of the plan.

1018.4 EXPOSURE PREVENTION AND MITIGATION

1018.4.1 GENERAL PRECAUTIONS

All members are expected to use good judgment and follow training and procedures related to mitigating the risks associated with communicable disease. This includes, but is not limited to (29 CFR 1910.1030; UAC R614-1-4):

- (a) Stocking disposable gloves, antiseptic hand cleanser, or other specialized equipment in the work area or department vehicles, as applicable.
- (b) Wearing department-approved disposable gloves when contact with blood, other potentially infectious materials, mucous membranes and non-intact skin can be reasonably anticipated.
- (c) Washing hands immediately or as soon as feasible after removal of gloves or other PPE.
- (d) Treating all human blood and bodily fluids/tissue as if it is known to be infectious for a communicable disease.
- (e) Using a face mask or shield if it is reasonable to anticipate an exposure to an airborne transmissible disease.
- (f) Decontaminating non-disposable equipment (e.g., flashlight, control devices, clothing and portable radio) as soon as possible if the equipment is a potential source of exposure.
 1. Clothing that has been contaminated by blood or other potentially infectious materials shall be removed immediately or as soon as feasible and stored/decontaminated appropriately.
- (g) Handling all sharps and items that cut or puncture (e.g., needles, broken glass, razors, knives) cautiously and using puncture-resistant containers for their storage and/or transportation.
- (h) Avoiding eating, drinking, smoking, applying cosmetics or lip balm, or handling contact lenses where there is a reasonable likelihood of exposure.
- (i) Disposing of biohazardous waste appropriately or labeling biohazardous material properly when it is stored.

1018.4.2 IMMUNIZATIONS

Members who could be exposed to HBV due to their positions may receive the HBV vaccine and any routine booster at no cost (29 CFR 1910.1030; UAC R614-1-4).

Salt Lake City Police Department

SLCPD Policy Manual

SLCPD Policy Manual

Communicable Diseases

Members shall also be screened for tuberculosis pursuant to the guidelines established by Utah OSHA (UAC R388-804).

1018.5 POST EXPOSURE

1018.5.1 INITIAL POST-EXPOSURE STEPS

Members who experience an exposure or suspected exposure shall:

- (a) Begin decontamination procedures immediately (e.g., wash hands and any other skin with soap and water, flush mucous membranes with water).
- (b) Seek medical attention at the University of Utah Medical Center Emergency Department (UMED).
- (c) Notify a supervisor as soon as practicable.
- (d) Notify CorVel as outlined in the Occupational Disease and Work-Related Injury Reporting Policy and Procedure.

1018.5.2 SOURCE TESTING

Testing a person for communicable diseases when that person was the source of an exposure should be done when it is desired by the exposed member or when it is otherwise appropriate. Source testing is the responsibility of the supervisor on scene.

Source testing may be achieved by:

- (a) Obtaining consent from the individual.
 1. Attempt to gain written consent for testing, using the Emergency Medical Service Provider Exposure Report Form (Form 350). Written consent must be documented in the Source Patient Information section of Form 350. [See attachment: Form 350.pdf](#)
- (b) If consent is refused, seek a warrant pursuant to Utah Code 78B-8-402.
 1. If a warrant is denied, document contact information for follow-up by the City Attorney's Office.
- (c) If the source patient does not need to be transported to a hospital for medical attention, coordinate the call-out of a department phlebotomist to complete the blood draw. If the phlebotomist is unable to obtain a sample, facilitate transport to UMED for completion of the blood draw.
 1. If the blood draw is performed anywhere other than at UMED, the source individual's blood draw must be transported to UMED by the drawing phlebotomist, along with the applicable paperwork (i.e., Form 350, search warrant, etc.), to ensure that testing is completed on the exposed officer's blood and the source individual's blood.
- (d) Facilitate transport of a source patient to a hospital if the individual has injuries requiring such.
 1. If practicable, the source individual should be transported to UMED.

Salt Lake City Police Department

SLCPD Policy Manual

SLCPD Policy Manual

Communicable Diseases

2. If the source individual is transported to a hospital other than UMED, the source individual's blood draw must be transported to UMED by the drawing phlebotomist, along with the applicable paperwork (i.e., Form 350, search warrant, etc.), to ensure that testing is completed on the exposed officer's blood and the source individual's blood.

The exposed employee shall complete the applicable portion of Form 350, and should keep a copy for their own documentation.

The supervisor on scene shall forward copies of all applicable documents to the ECO.

1018.5.3 REPORTING REQUIREMENTS

The supervisor on-duty shall investigate every exposure or suspected exposure that occurs as soon as possible following the incident. The supervisor shall ensure the following information is documented (29 CFR 1910.1030; UAC R614-1-4):

- (a) Name of the member exposed
- (b) Date and time of the incident
- (c) Location of the incident
- (d) Potentially infectious materials involved and the source of exposure (e.g., identification of the person who may have been the source)
- (e) Work being done during exposure
- (f) How the incident occurred or was caused
- (g) PPE in use at the time of the incident
- (h) Actions taken post-event (e.g., clean-up, notifications)

1018.5.4 MEDICAL CONSULTATION, EVALUATION AND TREATMENT

Department members shall have the opportunity to have a confidential medical evaluation immediately after an exposure and follow-up evaluations as necessary (29 CFR 1910.1030; UAC R614-1-4).

The ECO should request a written opinion/evaluation from the treating medical professional that contains only the following information:

- (a) Whether the member has been informed of the results of the evaluation.
- (b) Whether the member has been notified of any medical conditions resulting from exposure to blood or other potentially infectious materials which require further evaluation or treatment.

No other information should be requested or accepted by the ECO.

1018.6 CONFIDENTIALITY OF REPORTS

Medical information shall remain in confidential files and shall not be disclosed to anyone without the member's written consent (except as required by law) (29 CFR 1910.1030; UAC R614-1-4;

Salt Lake City Police Department

SLCPD Policy Manual

SLCPD Policy Manual

Communicable Diseases

Utah Code 26-6-27). Test results from persons who may have been the source of an exposure are to be kept confidential as well.

1018.7 TRAINING

All members shall participate in training regarding communicable diseases commensurate with the requirements of their position. The training (29 CFR 1910.1030; UAC R614-1-4):

- (a) Shall be provided at the time of initial assignment to tasks where an occupational exposure may take place and at least annually after the initial training.
- (b) Shall be provided whenever the member is assigned new tasks or procedures affecting his/her potential exposure to communicable disease.
- (c) Should provide guidance on what constitutes an exposure, what steps can be taken to avoid an exposure and what steps should be taken if a suspected exposure occurs.

1018.8 REVISIONS

Enacted: May 14, 2018

Occupational Disease and Work-Related Injury Reporting

1019.1 PURPOSE AND SCOPE

The purpose of this policy is to provide guidance regarding the timely reporting of occupational diseases and work-related injuries.

1019.1.1 DEFINITIONS

Definitions related to this policy include:

Work-related injury or occupational disease - An accidental injury or occupational disease that arises out of and in the course of employment with the Salt Lake City Police Department. The disease must be medically caused or aggravated by that employment. An occupational disease may include a physical, mental or emotional disease related to mental stress that arises out of and in the course of employment (Utah Code 34A-3-103; Utah Code 34A-3-106; UAC R612-100-2).

1019.2 POLICY

The Salt Lake City Police Department will address occupational diseases and work-related injuries appropriately, and will comply with applicable state workers' compensation requirements (Utah Code 34A-2-407; UAC R612-200-1).

Members who fail to follow proper procedure in reporting injuries may lose their rights to compensation.

1019.3 RESPONSIBILITIES

1019.3.1 MEMBER RESPONSIBILITIES

Any member sustaining any occupational disease or work-related injury shall report such event as soon as practicable, but within 24 hours, to a supervisor, and shall seek medical care when appropriate.

If the injury is life threatening, or the member needs urgent medical attention while the approved Direct Care Facilities are not open, they should report to the nearest medical emergency facility.

If the injury is not life threatening, the employee must report to a Direct Care Facility for Salt Lake City:

- Salt Lake WorkMed
1685 West 2200 South
Monday-Friday 0700-1900
(801) 972-8850
- Salt Lake InstaCare (Urgent Care)
389 South 900 East

Salt Lake City Police Department

SLCPD Policy Manual

SLCPD Policy Manual

Occupational Disease and Work-Related Injury Reporting

Monday-Friday 0900-2100

Saturday and Sunday 0900-1700

(385) 282-2400

- Memorial InstaCare (Urgent Care)

2000 South 900 East

Everyday 0900-2100

(801) 464-7777

Employees shall also follow proper procedure for reporting the injury to their supervisor and the City's third party risk management firm. [Salt Lake City Police Department Procedure Manual: 1004.2 EMPLOYEE INJURY REPORTING REQUIREMENTS](#)

1019.3.2 SUPERVISOR RESPONSIBILITIES

A supervisor learning of any occupational disease or work-related injury should ensure the member receives medical care as appropriate. If the injuries are visible and the circumstances permit, the supervisor should ensure that Crime Lab photographs and documents the injuries.

Supervisors shall follow proper notification and reporting procedures. [Salt Lake City Police Department Procedure Manual: 1004.3 WORK-RELATED INJURY PROCEDURES FOR SUPERVISORS](#)

1019.4 REVISIONS

Enacted: May 14, 2018

Revised: June 29, 2020

Personal Appearance Standards

1020.1 PURPOSE AND SCOPE

In order to project uniformity and neutrality toward the public and other members of the Department, it is the policy of the Department that employees shall maintain their personal hygiene and appearance to project a professional image appropriate for this department and for their assignment.

1020.2 GROOMING STANDARDS

Unless otherwise stated and because deviations from these standards could present officer safety issues, the following appearance standards shall apply to all employees, except those whose current assignment would deem them not appropriate, and where the Chief of Police or designee has granted exception.

1020.2.1 HAIR

Hairstyles of all members shall be neat in appearance. If hair is highlighted or dyed, it must be done with natural hair colors. Any extreme fluorescent or colored dyes or highlights are not authorized. Hairstyles must present a professional, businesslike image.

For all male members, hair must not extend below the top edge of a uniform collar while assuming a normal stance. Hair shall not fall more than 1/2" over the top of the ears and shall not touch the eyebrows. Pony-tails and man-buns are not authorized.

For female sworn members, hair must be no longer than the horizontal level of the bottom of the uniform patch when the employee is standing erect, and bangs shall not touch the eyebrows. Long hair must be pulled back away from the face, except for bangs; it can be worn up or in a tightly wrapped braid or ponytail. Pigtails and loose styles are not authorized. When wearing the "Class A" uniform hair must fit under the hat or cap, and must also look professional and not present an unkempt appearance if the hat or cap is removed while still in uniform.

Civilian female personnel may wear their hair in loose styles, so long as those styles are professional and are not extreme.

1020.2.2 FACIAL HAIR

Members may be permitted to wear a mustache, full goatee, or full beard so long as the facial hair is maintained in a manner that presents a groomed and professional appearance. Sworn members may wear facial hair while in uniform or in plain clothes, when the member is in compliance with this section. Facial hair must not interfere with the wearing of any necessary protective equipment, or expose the wearer to undue risk or hazard. No variations or exceptions will be allowed without approval from the Chief.

Facial hair shall not exceed one half inch (1/2") in length when laying naturally and measured out from the face. The mustache portion of any goatee or beard may not extend laterally more than one half inch (1/2") from the corner of the mouth and will be trimmed so that both lips are visible. Goatees and beards must be trimmed in a clean line along the contour of the jawline

Salt Lake City Police Department

SLCPD Policy Manual

SLCPD Policy Manual

Personal Appearance Standards

and cheekbones, and the neck area must be clean shaven. Beards and goatees may not be worn without a mustache. Beards must attach to the sideburns and must follow the contour of the cheekbone and be no higher than the bottom portion of the nose.

To keep members from constantly being in the state of initial facial hair growth (i.e. shaving and starting a new beard within a few days or weeks), no member shall be allowed to start a beard more than two (2) times within any 12 month period unless special circumstances exist and permission is granted from the Chief. Additionally, members must begin any facial hair growth on their off days and must have a minimum of two days growth to wear facial hair while in a uniform or on-duty.

No extreme styles of facial hair will be permitted. All segments of facial hair which are worn must be contiguously connected. Mutton chops, pencil beards, chin straps, chin curtains, etc. will not be permitted. The Chief shall have the final approval in determining what is considered extreme.

It is recognized that some members will not be capable of growing facial hair that has a neat appearance (scraggly, patchy, sparse, etc.) Members will not be allowed to wear facial hair that does not have an even, neat, clean, and well-trimmed appearance. If a supervisor feels that any facial hair does not meet the criteria outlined in this policy, or if they feel a member is unable to maintain a professional appearance, they may require the member to shave. A member who has been directed to shave due to a violation of this policy on more than two occasions may be subject to progressive discipline and could be permanently prohibited from wearing facial hair while in uniform or on-duty.

Members should recognize that facial hair may distract from a professional appearance while wearing a Dress or Class A uniform and may not be appropriate for some events or special details.

At the discretion of the Chief, members serving in some special assignments may be prohibited from wearing facial hair.

At the discretion of the Chief, members serving in some special assignments (e.g. undercover) may be exempt from the requirements of the facial hair policy.

Supervisors at all levels of the organization shall be responsible for the members they supervise and should ensure compliance with this policy. Compliance should be maintained through daily observation and through regular uniform and grooming inspections.

The Chief shall maintain final approval over the facial hair section of this policy.

1020.2.3 MUSTACHES

A short and neatly trimmed mustache may be worn. Mustaches shall not extend below the corners of the mouth or beyond the natural hairline of the upper lip. Handlebar type mustaches are not authorized.

1020.2.4 SIDEBURNS

Members may not wear sideburns that extend below the lowest portion of the ear unless they are connected to a full beard. Sideburns will not flare or bush out and shall have a trimmed and neat

Salt Lake City Police Department

SLCPD Policy Manual

SLCPD Policy Manual

Personal Appearance Standards

appearance. The base will be clean shaven, perpendicular to the vertical tapered line, and shall be a maximum of 1 1/2" in width.

1020.2.5 JEWELRY AND ACCESSORIES

Jewelry, if worn around the neck, shall not be visible above the shirt collar for sworn members.

Female officers may wear no more than one earring per ear. The earrings must be small stud style earrings.

Non-sworn female members may wear no more than two earrings per ear. The style may not detract from the professional image of the Department.

Male members shall not wear earrings while on-duty.

Non-sworn members are allowed to wear other jewelry and accessories so long as it is not in excess and will not detract from the professional image of the department.

1020.3 TATTOOS

Employees are permitted to display tattoos and body art on their arms and legs when they do not distract or interfere with the employee's on-duty actions and responsibilities. Tattoos that are found to be offensive, obscene, vulgar, depict graphic nudity, or are prejudicial to any segment of the population are strictly prohibited. Any tattoos that may potentially bring discredit upon the Salt Lake City Police Department are also prohibited.

At the direction of the Chief of Police, a committee of 5 employees will review expressed concerns and will make a recommendation to the Chief whether or not an individual tattoo(s) or body art is acceptable for public viewing while an employee is on-duty and representing the Department. This committee will consist of one command staff member and four employees from various divisions in the Department. The committee should, as equally as possible, represent both male and female employees, supervisors and non-supervisors, sworn and non-sworn, employees with and without visible tattoos, and have at least one member from the Salt Lake Police Association. The committee will meet as needed to address concerns regarding tattoos and body art on an individual employee basis. The committee will notify the employee by email of their determinations and send a recommendation to the Chief of Police for final approval. Whether a tattoo's content is deemed appropriate or inappropriate is ultimately at the discretion of the Chief of Police.

Employees are not permitted to display tattoos that are located on the neck above the collarbone, the face, head or hands. Exceptions to this include cosmetic micro-blading tattoos and a single tattoo on the left ring finger may be allowed. The tattoo, if allowed, will only be in the area of the finger where a normal wedding style ring would be placed.

Tattoos and body art will be covered at all times when an employee is required to appear at all court and administrative hearings, and any official departmental ceremonies and public safety funerals. Tattoos that are deemed inappropriate or prohibited by this policy will be covered by the employee's uniform, or a black or navy blue colored tattoo cover.

Salt Lake City Police Department

SLCPD Policy Manual

SLCPD Policy Manual

Personal Appearance Standards

1020.4 BODY PIERCING OR ALTERATION

Body piercing (other than earrings) or alteration to any area of the body visible in any authorized uniform or attire that is a deviation from normal anatomical features and which is not medically required is prohibited. Such body alteration includes, but is not limited to:

- (a) Tongue splitting or piercing.
- (b) Ear gauging.
- (c) The complete or transdermal implantation of any material other than hair replacement.
- (d) Abnormal shaping of the ears, eyes, nose or teeth.
- (e) Branding or scarification.

1020.5 REVISIONS

Enacted: May 14, 2018

Revised: July 26, 2019

Revised: October 2, 2020

Uniform Regulations

1021.1 PURPOSE AND SCOPE

The uniform policy of the Salt Lake City Police Department is established to ensure that uniformed personnel will be readily identifiable to the public through the proper use and wearing of Department uniforms. Employees should also refer to the following associated policies:

- Department-Owned and Personal Property
- Body Armor
- Grooming Standards

The Salt Lake City Police Department will provide uniforms for all employees required to wear them in the manner, quantity, and frequency agreed upon in the respective employee group's collective bargaining agreement or compensation plan.

All specifications for approved uniforms and equipment (including brands and models) will be maintained by the Quartermaster.

For information on uniform purchasing and replacement procedures, employees should refer to the Uniform and Equipment Issuance/Purchasing Procedure.

1021.2 WEARING AND CONDITION OF UNIFORM AND EQUIPMENT

Sworn police employees wear the uniform to be identified as the law enforcement authority in society. The uniform also serves an equally important purpose which is to identify a wearer as a source of assistance in an emergency, crisis or other time of need.

- (a) Uniforms and equipment shall be maintained in a serviceable condition and shall be ready at all times for immediate use. Uniforms shall be neat, clean, and appear professionally pressed.
- (b) All peace officers of the Department shall possess and maintain at all times a serviceable uniform and the necessary equipment to perform uniformed field duty.
- (c) Personnel shall wear only the uniform specified for their rank and assignment.
- (d) All supervisors will perform periodic inspections of their personnel to ensure conformance to these regulations.
- (e) Civilian attire shall not be worn in combination with any distinguishable part of the uniform.
- (f) Employees are not to purchase or drink alcoholic beverages while wearing any part of the Department uniform.
- (g) Mirrored sunglasses will not be worn with any Department uniform.

Salt Lake City Police Department

SLCPD Policy Manual

SLCPD Policy Manual

Uniform Regulations

1021.2.1 OFF-DUTY/SECONDARY EMPLOYMENT

The uniform may be worn off-duty if the wearer does not engage in any activity that reflects in a negative or discreditable way upon the uniform, nor will the wearer be present in such places where the atmosphere may bring discredit upon the police service that the uniform symbolizes.

The uniform shall be worn while engaged in approved secondary employment (see the Secondary Employment and Outside Employment Policy for exceptions). Uniforms are not authorized for employment at locations that are not within the corporate boundaries of Salt Lake City.

When worn, the uniform shall be complete and in compliance with the standards listed in this policy.

1021.2.2 UNIFORM CLEANING

Employees in a uniformed assignment may have their uniforms cleaned at Department-authorized vendors. If officers choose to take their uniforms to other vendors, the Department will not pay for the service. The names and locations of Department-authorized vendors will be published periodically in a Chief's Memorandum.

Police officers in a plain-clothes assignment, as determined by their Division Commander, shall receive a cleaning allowance as specified in the applicable memorandum of understanding or compensation plan.

1021.2.3 DEPARTMENT-ISSUED IDENTIFICATION

The Department issues each employee an official Department identification card bearing the employee's name, identifying information and photo likeness. All employees shall be in possession of their Department-issued identification card at all times while on-duty or when carrying a concealed weapon.

- (a) Whenever on-duty or acting in an official capacity representing the Department, employees shall display their Department-issued identification in a courteous manner to any person upon request and as soon as practical.
- (b) Officers working specialized assignments may be excused from the possession and display requirements when directed by their Division Commander.

1021.3 UNIFORM CLASSES

1021.3.1 CLASS A UNIFORM

The Class A uniform is to be worn on special occasions, such as funerals, graduations, ceremonies, or as directed. All sworn personnel shall keep and maintain a Class A uniform.

- The Class A uniform without coat (the coat is optional for officer rank employees) will consist of:
 - Equipment belt (leather or synthetic leather), in basket weave pattern with silver buckle. Only a holster, magazine case, handcuff case, and keepers will be worn on the belt.
 - Dress Cap.

Salt Lake City Police Department

SLCPD Policy Manual

SLCPD Policy Manual

Uniform Regulations

- Black shoes/boots with plain, polished toe or high gloss shoes (boots with pointed toes are not permitted).
- Socks must be black in color. If white socks must be worn due to a medical problem, black socks will be worn over the white socks.
- Class A straight leg uniform pants (no cargo pockets allowed).
- Long-sleeve uniform shirt with tie and silver polished tie bar.
- All Sergeants, Lieutenants, Captains, and Chief's will maintain a Class A uniform with coat; this is the designated Class A uniform for these ranks. Officer rank employees are authorized to wear the Class A uniform with a coat as an option.
 - The Class A uniform with coat for officer rank will consist of:
 - Long sleeve, blue uniform shirt with tie and silver polished tie bar.
 - Flying Cross single-breasted dress coat in 55/45 poly/wool, with pleated chest pockets in navy blue. The coat will have shoulder patches and silver "P" buttons.
 - Straight leg, duty uniform trousers without cargo pockets.
 - Black dress belt with silver buckle.
 - Black shoes/boots with plain, polished toe or high gloss shoes (boots with pointed toes are not permitted).
 - Socks must be black in color. If white socks must be worn due to a medical problem, black socks will be worn over the white socks.
 - Dress cap.
 - Nameplates (to be worn on coat and shirt).
 - Awards may be worn above the nameplate on the coat.
 - The Class A uniform with coat for Sergeants, Lieutenants, Captains, and Chiefs will consist of:
 - Flying Cross or Elbeco long sleeve dress shirt in white with shoulder patches, nameplate, and badge tab. The dress shirt will not to be altered to a short sleeve option.
 - Straight leg, uniform trousers without cargo pockets.
 - Flying Cross single-breasted dress coat in 55/45 poly/wool, with pleated chest pockets in navy blue. The coat will have shoulder patches and gold "P" buttons.
 - Black dress belt with gold buckle.
 - Black shoes/boots with plain, polished toe or high gloss shoes (boots with pointed toes are not permitted).
 - Socks must be black in color. If white socks must be worn due to a medical problem, black socks will be worn over the white socks.

Salt Lake City Police Department

SLCPD Policy Manual

SLCPD Policy Manual

Uniform Regulations

- Dress cap.
- Tie with gold polished tie bar.
- Nameplates (to be worn on coat and shirt).
- Awards may be worn above the nametag on the coat.
- Metal rank insignia will be worn on shirt and coat.
- Sleeve rank braids will be worn as follows:
 - 1 braid for Lieutenants
 - 2 braids for Captains
 - 3 braids for Deputy Chiefs
 - 4 braids for Assistant Chiefs
 - 5 braids for Chief of Police

1021.3.2 CLASS B UNIFORM

All officers will possess and maintain a serviceable Class B uniform at all times.

The Class B uniform will consist of:

- (a) A long- or short-sleeve blue uniform shirt. Sergeants, Lieutenants, Captains, and Chiefs may wear a long- or short-sleeve white uniform shirt. A tie with a tie bar is optional, but it may only be worn with a long-sleeve shirt.
- (b) Approved optional vest carriers may be worn instead of regular duty shirts.
- (c) A white or black crew-neck tee-shirt may be worn under a blue uniform shirt. A white crew-neck tee-shirt may be worn under a white uniform shirt.
- (d) A black turtleneck shirt may be worn under the long-sleeved uniform shirt. No embroidery is allowed on the turtleneck.
- (e) All shirt buttons must remain buttoned except for the last button at the neck.
- (f) Class A straight leg or cargo pants.
 - i. Shorts may be worn year-round.
 - ii. Shorts worn with the Class B uniform must be of the same blend, weave, and color as the short-sleeve duty shirt.
 - iii. Shorts may only be worn with a short-sleeve blue uniform shirt.
- (g) Footwear must be a boot or shoe, black in color, professional looking, with no visible logos or contrasting designs. Boots with pointed toes are not permitted.
- (h) Socks must be black in color. If white socks must be worn due to a medical problem, black socks will be worn over the white socks.
 - 1. Socks worn with shorts may be white or black in color. They shall not have any logos, stripes, or other colors, and may be no higher than mid-calf.

Salt Lake City Police Department

SLCPD Policy Manual

SLCPD Policy Manual

Uniform Regulations

- (i) Pants belt and duty belt will be the same material; either black nylon, leather, or synthetic leather. Keepers will match the belt material.
- (j) All equipment and accessories worn on the duty belt will match the belt material. Only Department-approved equipment and accessories shall be worn. Gear to be worn on the duty belt:
 - i. Handcuff case with handcuffs
 - ii. Flashlight
 - iii. Holster and handgun
 - iv. Magazine pouches with at least two magazines
 - v. Baton and/or OC spray
 - vi. Radio holder and radio
 - vii. CED with holster

1021.3.3 DETECTIVE UNIFORM

The detective uniform shall consist of a blue polo shirt, grey colored pants, and matching black belt and boots. Socks will be black or of the same color as the boots. Officers will have at least one spare magazine on their belt and handcuffs on their person.

The blue polo shirt will have a badge insignia embroidered on the left breast. The word "POLICE" shall be embroidered on both sleeves and the back of the collar in white. The officer's first initial and last name shall be embroidered on the right breast in white. The shirt shall be worn with only the top button open.

Sergeants and above authorized to wear the detective uniform shall wear miniature metal gold collar rank insignias. No variations to the coloring of the insignias is allowed. The rank insignias shall be affixed from the leading edge of the collar, parallel to the front edge of the collar, and centered between the top and bottom edge.

1021.3.4 SPECIALIZED UNIT UNIFORMS

The Chief of Police or designee may authorize special uniforms to be worn by officers in specialized units, such as Canine Team, SWAT, Bicycle Patrol, Motor Officers and other specialized assignments.

1021.3.5 FOUL WEATHER GEAR

All officers will be issued a winter coat and a lightweight or fleece jacket.

Officers may purchase any black or navy blue beanie from the department's primary vendor, designated by the quartermaster. The beanie must be form-fitting and be able to be used under a ballistic helmet. All beanies are required to have "SLCPD" embroidered on the front. All additional logos will need to be subdued, so as to not take away from the overall professional appearance.

Snowmobile boots may be worn during cold, snowy weather, so long as they are to be all black in color.

Salt Lake City Police Department

SLCPD Policy Manual

SLCPD Policy Manual

Uniform Regulations

1021.3.6 LOAD-BEARING VESTS (LBV)

Approved optional load-bearing vests (LBV) may be worn with the Class B uniform, detective uniform, and specialty squad uniforms.

The following shall apply to LBVs:

- (a) Dark navy blue Safariland LBVs with MOLLE front zip (Model: Oregon City) is approved.
- (b) Authorized pouches are High-Speed Gear TACO MOLLE in black.
 - i. Pouches must be securely affixed to the LBV.
 - ii. Pouches must retain their shape and finish under load.
 - iii. The LBV shall present a professional, streamlined appearance and shall not be overloaded with pouches.
 - iv. The maximum number of pouches authorized is five.
 - v. The following types of pouches are approved:
 - (a) Single or double handgun magazine pouch.
 - (b) ASP/baton pouch.
 - (c) Radio pouch.
 - (d) OC spray pouch.
 - (e) Tourniquet pouch.
 - (f) Small utility pouch.
 - (g) CED holster with MOLLE mount.
 - (h) BWC pouch/MOLLE mount.
 - vi. Pouch placement is left to the discretion of the officer, with the exception that a CED shall be worn in a manner consistent with a support hand draw.
 - vii. Rifle magazines shall not be worn visibly on the LBV.
- (c) The standard Department-issued metal badge shall be worn on the left breast.
- (d) A cloth name tape shall be worn on the right breast.
 - i. It shall display the employee's first initial and last name. Service years stars shall not be worn with the LBV flex nameplate.
- (e) A 2" x 6" patch bearing the word "POLICE" shall be worn under the metal badge.
- (f) A 4" x 8" patch bearing the word "POLICE" shall be worn on the back of the LBV. The text shall be non-reflective, gray in color.
- (g) Additional patches and/or memorabilia shall not be worn on the LBV.
- (h) Members shall maintain their LBV in a clean condition and in good repair. LBVs are subject to inspection by supervisors.

Salt Lake City Police Department

SLCPD Policy Manual

SLCPD Policy Manual

Uniform Regulations

- (i) Approved vest carrier undershirts (as specified by the Quartermaster) shall be worn under the LBV.
 - i. The Flying Cross DutyGuard HT pullover (LAPD Navy with SLCPD shoulder patches attached) may be worn under the LBV.

1021.4 BADGES, INSIGNIA, AND ORNAMENTATION

1021.4.1 BADGES AND SHOULDER PATCHES

The Department-issued badge or an authorized sewn-on cloth replica must be worn and visible at all times while in uniform.

- (a) The standard Department-issued metal badge shall be worn on the standard uniform shirt and Class A uniform cap.
 - i. Other badges may be worn during specified times as prescribed by the Chief of Police.
- (b) An embroidered badge insignia will be worn on the baseball hat.
- (c) The standard Department-issued metal badge shall be worn on the outer shell of the winter coat.
 - i. Other badges may be worn during specified times as prescribed by the Chief of Police.
- (d) An embroidered badge insignia shall be worn on the fleece or lightweight jacket.

The authorized shoulder patch supplied by the Department shall be machine stitched to the sleeves of all uniform shirts, jackets, and coats, with the top edge against the shoulder seam of the sleeve, and bisected by the crease in the sleeve.

1021.4.2 INSIGNIA

Sergeant Insignia – Sergeant stripes are to be worn with the stripes in an inverted “V” position, centered on the side of the sleeves with the top of the chevron touching the lower point of the shoulder patch on all uniform shirts and jackets. Metal $\frac{3}{4}$ ” gold chevrons will be worn on the collar of detective and bike shirts as well as the white shirt if wearing the Class A uniform coat. Larger gold insignia will be worn centered on the outer square of the Class A uniform coat epaulettes.

Command Level Rank Insignia – Gold colored metal rank insignia will be worn on all shirts and outerwear of Lieutenants, Captains, and Chiefs. Embroidered or stick-on insignia is not authorized. The insignia of Lieutenants and Captains will be placed at the leading edge of the collar, parallel to the front edge of the collar, and centered between the top and bottom edge. The star insignia of Chiefs will be placed perpendicular to the bottom edge of the collar. Metal rank insignia will be worn centered on the outer square of jacket and Class A uniform coat epaulettes. Rank insignia will be worn as follows:

- (a) Lieutenants will wear single $\frac{3}{4}$ ” gold colored bars on shirt collars and 1” bars on outerwear epaulettes.

Salt Lake City Police Department

SLCPD Policy Manual

SLCPD Policy Manual

Uniform Regulations

- (b) Captains will wear double $\frac{3}{4}$ " gold colored bars on shirt collars and 1" bars on outerwear epaulettes.
- (c) Deputy Chiefs will wear double $\frac{5}{8}$ " stars on shirt collars and outerwear epaulettes.
- (d) The Assistant Chief will wear triple $\frac{5}{8}$ " stars on shirt collars and outerwear epaulettes.
- (e) The Chief of Police will wear quad $\frac{5}{8}$ " stars on shirt collars and outerwear epaulettes.

1021.4.3 ORNAMENTATION

- (a) Service stars (optional) - Service stars will be centered over the nameplate. The single point of the star must be pointed upward. Each star represents five years of service as a police officer.
- (b) The regulation nameplate, or an authorized sewn-on cloth nameplate, shall be worn at all times while in uniform. The nameplate shall display the employee's first initial and last name or just the last name. The nameplate shall be worn and placed above the right pocket located in the middle, bisected by the pressed shirt seam, with equal distance from both sides of the nameplate to the outer edge of the pocket. The nameplate will be polished silver with black letters for officers, and polished gold with black letters for sergeants and above.
- (c) Assignment Insignias - Assignment insignias (e.g., SWAT, FTO, Motors, etc.) may be worn. The pins must be centered above the nameplate or above the service stars or awards with no space in between the nameplate, service stars, or awards. Only one pin may be worn at any time.
- (d) Outside agencies/organizations – Badges and pins awarded by outside agencies and organizations may be worn when approved by the Chief of Police. A pin representing the PMAA or SLPA may be worn on the uniform as long as it is no larger than $\frac{7}{8}$ " square in dimension. These pins shall be worn on the right pocket flap centered directly above the button.
- (e) Crisis Intervention Team (CIT) Pin – A CIT pin may be worn on all uniforms. The CIT pin may be worn in place of an outside agency/organization pin or in place of an assignment insignia. When worn on the utility or bicycle uniform, the CIT pin shall be centered above the embroidered name or service stars.
- (f) The Chief of Police may authorize temporary promotional ribbons or pins to be worn.
- (g) Tie Bar – The tie bar will be approximately $\frac{5}{16}$ " wide by 2" long. It shall be polished silver for officers and polished gold for sergeants and above. The tie bar shall be placed on the tie horizontally and level with the bottom points of the shirt pockets.

1021.4.4 MEDALS

- (a) If only one medal is worn, it shall be worn on the shirt or coat centered above the nameplate, or above the service stars with no space in between the nameplate or service stars.
- (b) If more than one medal is worn, they shall be worn centered above the nameplate or service stars, with no space in between the nameplate or service stars, in descending order of precedence from right to left. The order of precedence is (in descending order):

Salt Lake City Police Department

SLCPD Policy Manual

SLCPD Policy Manual

Uniform Regulations

- i. Medal of Valor
 - ii. Police Medal
 - iii. Police Star
 - iv. Police Distinguished Service Medal
 - v. Police Meritorious Service Medal
- (c) Three medals shall constitute a complete row. Precedence of rows shall be top to bottom. Additional rows shall also extend toward the wearer's left in descending order of precedence. An incomplete row shall be the top row with its medals centered on the complete row(s) beneath.
- (d) When an employee receives the same award more than once, the second and subsequent awards shall be indicated by a silver oak-leaf cluster worn on the original ribbon. A silver star will be worn in lieu of five silver oak-leaf clusters.

1021.4.5 MOURNING BADGE

Uniformed employees may wear a black mourning band across the uniform badge whenever a law enforcement officer is killed in the line of duty. The following mourning periods will be observed:

- (a) An officer of the Department - From the time of death until midnight on the 14th day after the death.
- (b) An officer from this or an adjacent county - From the time of death until midnight on the day of the funeral.
- (c) Funeral attendee - While attending the funeral of an out-of-region fallen officer.
- (d) National Peace Officers Memorial Day (May 15) - From 0001 hours until 2359 hours.
- (e) As directed by the Chief of Police.

1021.5 CIVILIAN ATTIRE

There are assignments within the Department that do not require the wearing of a uniform because recognition and authority are not essential to their function. There are also assignments in which the wearing of civilian attire is necessary.

- (a) All employees shall wear clothing that fits properly, is clean and free of stains, and not damaged or excessively worn.
- (b) All male administrative, investigative, and support personnel who elect to wear civilian clothing to work shall wear button-style shirts with a collar, and slacks or suits that are moderate in style.
- (c) All female administrative, investigative, and support personnel who elect to wear civilian clothes to work shall wear dresses, slacks, shirts, blouses or suits that are moderate in style.
- (d) All sworn personnel who elect to wear civilian clothing to work shall wear the standard Department-issued metal badge.

Salt Lake City Police Department

SLCPD Policy Manual

SLCPD Policy Manual

Uniform Regulations

1. Other badges may be worn during specified times as prescribed by the Chief of Police.
- (e) The following items shall not be worn on-duty:
 1. Tee-shirt alone.
 2. Open-toed sandals or flip-flops.
 3. Swimsuit, tube tops, or halter-tops.
 4. Spandex-type pants or see-through clothing.
 5. Distasteful printed slogans, buttons, or pins.
- (f) Variations from this order are allowed at the discretion of the Chief of Police or designee when the employee's assignment or current task is not conducive to the wearing of such clothing.
- (g) No item of civilian attire may be worn on-duty that would adversely affect the reputation of the Salt Lake City Police Department or the morale of the employees.

1021.6 COURT ATTIRE

All officers may wear Department-approved uniforms when appearing in court for Department-related business. Officers may also dress in business attire for court following the guidelines below:

- (a) Female personnel who elect not to wear an approved uniform to court shall wear dresses, slacks, shirts, blouses or suits that are moderate in style. Dress pumps or low-heel shoes are appropriate footwear.
- (b) Male personnel who elect not to wear an approved uniform to court shall wear dress shirts with a collar and tie, dress-type slacks, or suits. Dress-type shoes, boots, or cowboy boots are appropriate footwear.
- (c) Neither male nor female personnel shall wear athletic-type shoes for court appearances.

1021.7 POLITICAL ACTIVITIES, ENDORSEMENTS, AND ADVERTISEMENTS

Unless specifically authorized by the Chief of Police, Salt Lake City Police Department employees may not wear a Department uniform, be photographed wearing the Department uniform, utilize a Department badge, patch or other official insignia, or cause to be posted, published or displayed, the image of another employee, or identify himself/herself as an employee of the Salt Lake City Police Department to do any of the following:

- (a) Endorse, support, oppose or contradict any political campaign or initiative.
- (b) Endorse, support, oppose or contradict any social issue, cause, or religion.
- (c) Endorse, support or oppose any product, service, company or other commercial entity.
- (d) Appear in any commercial or motion picture.

Salt Lake City Police Department

SLCPD Policy Manual

SLCPD Policy Manual

Uniform Regulations

1021.8 UNAUTHORIZED UNIFORMS, EQUIPMENT AND ACCESSORIES

Salt Lake City Police Department employees may not wear any uniform item, accessory, or attachment unless authorized by the Department.

1021.8.1 GLOVES

The following types of gloves are authorized:

- (a) Leather and synthetic fabric gloves.
- (b) Gloves lined with soft padding (e.g., leather, synthetic fabrics, foam, etc.).
- (c) Full-fingered Kevlar fabric gloves that are specifically designed to protect the hands from cuts and/or punctures.

Sap gloves and weighted gloves are prohibited. Gloves with a hard element along the knuckles (e.g., carbon fiber, hardened plastic, etc.) are prohibited except for officers acting in specific assignments as noted below:

- (a) Motor Squad
- (b) SWAT Unit
- (c) Public Order Unit

Officers in the above-listed assignments may wear gloves with a hard element along the knuckles for protective purposes if approved by their Division Commander and upon receiving Department-approved training regarding such gloves.

1021.9 REVISIONS

Enacted: May 14, 2018

Revised: May 21, 2018

Revised: January 29, 2019

Revised: September 14, 2022

Revised: February 22, 2023

Police Explorers

1022.1 PURPOSE AND SCOPE

Explorers are young adults aged 14 through 20 who are interested in careers in law enforcement. Explorers work under direct supervision to perform a variety of routine and progressively more advanced tasks in a program intended to build character and prepare them for a career in law enforcement. Explorers are involved in community service through community outreach and service with law enforcement officers.

1022.2 EDUCATION REQUIREMENTS

Explorers are required to maintain a minimum grade point average of 2.0 ("C" grade) for all courses taken while in high school. Explorers are encouraged to continue their education through college courses or vocational training.

1022.3 LEAD EXPLORER ADVISOR

The Lead Explorer Advisor will serve as the Program Coordinator under the direction of the Public Relations Unit Sergeant. The Lead Explorer Advisor will be responsible for tracking the educational performance of explorers as well as making their individual assignments throughout the Explorer Post. The Lead Explorer Advisor will also monitor the training provided for all explorers and review all decisions affecting assignments, school attendance, and explorer evaluations.

1022.3.1 COLLATERAL ADVISORS

The Lead Explorer Advisor, under the direction of the Public Relations Unit Sergeant, may select individual officers to serve as collateral advisors for the Explorer Program. These officers will serve as mentors for the explorers in the Explorer Post. Explorers may bring special requests, concerns, and suggestions to their lead advisor or the collateral advisors for advice or direction. For matters related to Explorer Post business, the Explorer Post chain of command should be followed. The Lead Explorer Advisor will assign collateral advisors areas of responsibility related to Explorer Post business. Any issues that may be a concern to an individual explorer's chain of command should be referred back to the Lead Explorer Advisor. Explorer Advisors will follow the "2 deep" leadership model at all times when dealing with explorers. This means that whenever an advisor deals with an explorer one-on-one, there will be at least one other advisor present during that interaction.

1022.4 ORIENTATION AND TRAINING

New explorers will receive an orientation of the organization and facilities during the recruitment process. New explorers will be required to complete fingerprinting and a background check before being given access to police facilities. New explorers will be required to attend the day academy for new explorers before being accepted into the Explorer Post.

Explorer training should be coordinated at the direction of the Lead Explorer Advisor, involving officers who have knowledge in the subject matter being taught. Training sessions will cover as many assignments in the police department as possible. In addition to job-specific training,

Salt Lake City Police Department

SLCPD Policy Manual

SLCPD Policy Manual

Police Explorers

information will be offered to prepare explorers to compete successfully in police-related fields, or in any other career field they choose. Training will take place during weekly explorer meetings.

1022.5 EXPLORER UNIFORMS

Each explorer will be provided a "Class A" and a "Class B" uniform while they serve in the Explorer Post. Explorers are required to purchase a "Class C" and "PT" uniform. Upon completion of the program, the explorer will return the "Class A" and "Class B" uniforms.

1022.6 EXPLORER CHAIN OF COMMAND

Explorers in the Explorer Post will report to an explorer chain of command. The explorer chain of command will include Corporals who report to Sergeants, Sergeants who report to Lieutenants and Lieutenants, who report to a Captain, who all report to the Lead Explorer Advisor. Individual explorers should be given assignments by their Sergeants on a regular basis to enhance explorers' development.

In general, senior explorers will be assigned to positions requiring more technical skill or responsibility, as well as serving to train explorers for new assignments or those new to the Explorer Post.

1022.7 RIDE-ALONG PROCEDURES

Explorers are permitted to participate in the Ride-A-Long program as set forth by the department. The Ride-A-Long program provides explorers with the opportunity to observe officers as they work in the field and gain firsthand knowledge of the patrol function. The Ride-A-Long program supplements classroom training in basic police procedure through observation and conversation with police officers. Explorers must complete Ride-A-Long training, complete all Ride-A-Long paperwork and waivers, and have approval of the Lead Explorer Advisor before requesting the Ride-A-Long from approved officers. Officers approved to take Explorers on Ride-A-Longs will be those serving as collateral advisors.

1022.8 EXPLORER EVALUATIONS

Explorers will adhere to policies and procedures as outlined in the Explorer Policy Manual. Upon successful completion of probation, explorers and senior explorers will be evaluated based on their adherence to explorer policy, educational requirements, and attendance to meetings and events. Explorers will be counseled by their chain of command and/or the Lead Explorer Advisor on any issues.

1022.9 REVISIONS

Enacted: May 14, 2018

Nepotism and Conflicting Relationships

1023.1 PURPOSE AND SCOPE

The purpose of this policy is to ensure equal opportunity and effective employment practices by avoiding actual or perceived favoritism, discrimination or other actual or potential conflicts of interest by or between members of the Department. These employment practices include: recruiting, testing, hiring, compensation, assignment, use of facilities, access to training opportunities, supervision, performance appraisal, discipline and workplace safety and security.

1023.1.1 DEFINITIONS

Definitions related to this policy include:

Appointee - An employee whose salary, wages, pay, or compensation is paid from public funds (Utah Code 52-3-1).

Business relationship - Serving as an employee, independent contractor, compensated consultant, owner, board member, shareholder or investor in an outside business, company, partnership, corporation, venture or other transaction where the Department employee's annual interest, compensation, investment or obligation is greater than \$250.

Conflict of interest - Any actual, perceived or potential conflict of interest in which it reasonably appears that a Department employee's action, inaction or decisions are or may be influenced by the employee's personal or business relationship.

Household member - A person who resides in the same residence as the public officer (Utah Code 52-3-1).

Nepotism - The practice of showing favoritism to relatives in appointment, employment, promotion or advancement by any public official in a position to influence these personnel decisions.

Personal relationship - Includes marriage, cohabitation, dating or any other intimate relationship beyond mere friendship.

Public official - A supervisor, officer or employee who is vested with authority by law, rule or regulation, or to whom authority has been delegated.

Relative - An employee's parent, stepparent, spouse, domestic partner, significant other, child (natural, adopted or step), sibling, grandchild or grandparent. The term also includes an employee's uncle, aunt, nephew, niece, first cousin, mother-in-law, father-in-law, brother-in-law, sister-in-law, son-in-law, or daughter-in-law (Utah Code 52-3-1).

Subordinate - An employee who is subject to the temporary or ongoing direct authority of a supervisor.

Supervisor - An employee who has temporary or ongoing direct authority over the actions, decisions, evaluation and/or performance of a subordinate employee.

Salt Lake City Police Department

SLCPD Policy Manual

SLCPD Policy Manual

Nepotism and Conflicting Relationships

1023.2 RESTRICTED DUTIES AND ASSIGNMENTS

The Department will not prohibit all personal or business relationships between employees. However, in order to avoid nepotism or other inappropriate conflicts, the following reasonable restrictions shall apply.

- (a) A public officer may not employ, appoint, vote for, or recommend the appointment of an appointee when the appointee will be directly supervised by a relative or a household member, unless the appointment occurs in compliance with the requirements of Utah Code 52-3-1.
- (b) Employees are prohibited from directly supervising or being directly supervised by any other employee who is a relative, household member, or with whom they are involved in a personal or business relationship.
 - 1. If circumstances require that such a supervisor/subordinate relationship exists temporarily, the supervisor shall make every reasonable effort to defer matters pertaining to the involved employee to an uninvolved supervisor.
 - 2. When personnel and circumstances permit, the Department will attempt to make every reasonable effort to avoid placing employees in such supervisor/subordinate situations. The Department, however, reserves the right to reassign any employee to another position within the same classification in order to avoid conflicts with any provision of this policy.
- (c) Employees are prohibited from participating in, contributing to or recommending promotions, assignments, performance evaluations, transfers or other personnel decisions affecting an employee who is a relative, household member, or with whom they are involved in a personal or business relationship.
- (d) Whenever possible, FTOs and other trainers will not be assigned to train relatives or household members. FTOs and other trainers are prohibited from entering into or maintaining personal or business relationships with any employee they are assigned to train until such time as the training has been successfully completed and the employee is off probation.
- (e) To avoid actual or perceived conflicts of interest, members of the Department shall refrain from developing or maintaining personal or financial relationships with victims, witnesses, or other individuals during the course of, or as a direct result of, any official contact.
- (f) Except as required in the performance of official duties or in the case of immediate relatives, employees shall not develop or maintain personal or financial relationships with any individuals they know or reasonably should know are under criminal investigation, are convicted felons, parolees, fugitives or registered sex offenders, or anyone who engages in serious violations of state or federal laws.

1023.2.1 EMPLOYEE RESPONSIBILITY

Prior to entering into any personal or business relationship or other circumstance which the employee knows or reasonably should know could create a conflict of interest or other violation of this policy, the employee shall promptly notify his/her uninvolved, next highest level of supervisor.

Salt Lake City Police Department

SLCPD Policy Manual

SLCPD Policy Manual

Nepotism and Conflicting Relationships

Whenever any employee is placed in circumstances that would require the employee to take enforcement action or provide official information or services to any relative or individual with whom the employee is involved in a personal or business relationship, the employee shall promptly notify his/her uninformed, immediate supervisor.

In the event that no uninformed supervisor is immediately available, the employee shall promptly notify dispatch to have another uninformed employee either relieve the involved employee or minimally remain present to witness the action.

1023.2.2 SUPERVISOR'S RESPONSIBILITY

Upon being notified of, or otherwise becoming aware of any circumstance that could result in or constitute an actual or potential violation of this policy, a supervisor shall take all reasonable steps to promptly mitigate or avoid such violations whenever possible. Supervisors shall also promptly notify their Division Commander or designee of such actual or potential violations, through the chain of command.

1023.3 REVISIONS

Enacted: May 14, 2018

Revised: December 17, 2018

Department Badges

1024.1 PURPOSE AND SCOPE

All Department issued badges are the sole property of the Salt Lake City Police Department. This includes, but is not limited to, breast shields, flat badges, coat badges, and hat badges that identify the bearer as police personnel or a police officer.

1024.2 CUSTODY OF BADGES

The Department will issue badges necessary to an employee's assignment and position. Upon termination of employment, all badges must be immediately surrendered. When rank advancement or other circumstances require the issuance of new or different badges, the badges being replaced must be surrendered to the department Quartermaster or purchased by the employee.

Employees are responsible for the care and security of all badges issued to them.

1024.3 LOSS OR THEFT OF BADGES

The loss or theft of a badge must be reported immediately to the employee's supervisor. A detailed initial report with case number describing the circumstances of the loss or theft will be submitted for follow-up investigation. The lost or stolen badge will be listed on NCIC whenever possible. After this process is completed, the employee will report to the Quartermaster with the case number for a replacement badge.

1024.4 TRANSFER OR CONVEYANCE OF BADGES

The Department and its employees will not convey, donate, sell, or otherwise transfer custody of a badge to anyone except under the following conditions:

- (a) At the express direction of the Chief of Police.
- (b) When an employee is promoted, the employee will be awarded one breast shield to commemorate years of service at the previous rank. Within five (5) working days following the promotion the employee shall report to the Quartermaster with the option to purchase the second breast shield, the flat badge, and/or hat badge. Any badges not purchased or gifted will be returned to the Quartermaster.
- (c) Upon recommendation and by approval of the Chief of Police an employee who retires in good standing with the department will be awarded one breast shield representing their rank at the time of retirement and will also receive a Retired Officer flat badge with wallet representing their rank at the time of retirement. The employee may request that the breast shield be placed on a commemorative service plaque. Prior to the employee's retirement date they will report to the Quartermaster with the option to purchase the second breast shield, the flat badge, and/or hat badge. Any badges not purchased or gifted will be returned to the Quartermaster.
- (d) The Department will charge \$40 for each badge purchased by employees. The employee will be provided with a receipt to document the transaction.

Salt Lake City Police Department

SLCPD Policy Manual

SLCPD Policy Manual

Department Badges

The Chief of Police reserves the right to change or alter the above conditions and/or processes at any time.

1024.5 REVISIONS

Enacted: May 14, 2018

Temporary Modified- and Transitional-Duty Assignments and Leaves of Absence

1025.1 PURPOSE AND SCOPE

This policy establishes procedures for providing temporary modified- and transitional-duty assignments, as well as leaves of absence. This policy is not intended to affect the rights or benefits afforded to employees under City policy, current collective bargaining agreements, or applicable law.

1025.1.1 DEFINITIONS

Definitions related to this policy include:

Light Duty Assignment Coordinator (LDAC) - Each Division's administrative Lieutenant is the LDAC for that respective Division. The LDAC is the centralized position responsible for assigning and tracking all modified- and transitional-duty assignments within a Division. LDACs will monitor all Department employees within their Division who are on modified- and transitional-duty to ensure that those employees are fulfilling their responsibilities regarding notifications and time-limits. While the LDAC is responsible for tracking all modified- and transitional-duty assignments, the supervisor to whom an employee is assigned while on modified- or transitional-duty will be responsible for the direct supervision of that employee.

Leave of Absence (LOA) – Eligible employees may be granted a leave of absence at the approval of the Chief of Police. A leave of absence provides job security for employees.

Transitional-Duty Assignment (Light Duty) – Eligible employees who incur an on-the-job injury, illness, or medical condition and are temporarily restricted from performing the job requirements of their current position may be granted a transitional-duty assignment at the approval of the Chief of Police. Such assignments will be on-site and productive in nature to the department.

Modified-Duty Assignment (Light Duty) – Eligible employees who incur an off-the-job injury, illness, or medical condition and are temporarily restricted from performing the job requirements of their current position may be granted a modified-duty assignment at the approval of the Chief of Police. Such assignments will be on-site and productive in nature to the department.

1025.2 POLICY

Subject to operational needs, the Chief of Police, or the Chief's designee from within the Police Department, may authorize leaves of absence, transitional-duty assignments, or modified-duty assignments for employees who incur an injury, illness, or medical condition (whether sustained on- or off-duty) resulting in temporary work limitations or restrictions. Such temporary leaves of absence or duty assignment requests are approved or denied at the discretion of the Chief of Police, or Chief's designee, on a case by case basis and are not an employee right unless eligible worker's compensation claims are involved. Employees who have filed a worker's compensation claim shall be given priority for transitional or modified assignments.

Salt Lake City Police Department

SLCPD Policy Manual

SLCPD Policy Manual

Temporary Modified- and Transitional-Duty Assignments and Leaves of Absence

1025.3 GENERAL CONSIDERATIONS

No position in the Salt Lake City Police Department shall be created or maintained as a temporary transitional- or modified-duty assignment.

Temporary modified- and transitional-duty assignments are subject to continuous reassessment, with consideration given to operational needs and the employee's ability to perform in a modified- or transitional-duty assignment. The Department does not have telecommuting modified- or transitional-duty assignments.

The Chief of Police or the authorized designee may restrict employees working in temporary modified- or transitional-duty assignments from wearing a uniform, displaying a badge, carrying a police firearm, operating an emergency vehicle, engaging in outside employment, or being otherwise limited in employing their peace officer powers.

1025.4 PROCESS

- A. Employees seeking a LOA under an applicable MOU shall submit a written request to the Office of the Chief. The request shall provide details regarding the rationale for such leave.
- B. Employees seeking transitional-duty assignments (on the job injury, illness, or medical condition) should submit a written request to their Division's LDAC and their direct supervisor. The request should include a completed Transitional-Duty Release form. Employees may not return to work until the LDAC or authorized designee approves the assignment and the Transitional-Duty Release form is submitted. The employee and the Police Department will work with the City's risk management team to coordinate the employee's return to work for a transitional-duty assignment. The following time frames are associated with transitional-duty assignments and may not exceed one (1) year in aggregate:
 1. FMLA, up to twelve (12) weeks
 2. Requested leave of absence (LOA), up to six (6) months
 3. Transitional-duty assignment, up to three (3) months
- C. Employees seeking modified-duty assignments (off the job injury, illness, or medical condition) should submit a written request to their Division's LDAC and their direct supervisor. The request should include a completed Modified-Duty Release form. Employees may not return to work until the LDAC or authorized designee approves the assignment and the Modified-Duty Release form is submitted. The following time frames are associated with modified-duty assignments and may not exceed seven-and-a-half (7.5) months in aggregate:
 1. FMLA, up to twelve (12) weeks
 2. Requested leave of absence (LOA), up to three (3) months
 3. Modified-duty assignment, up to one-and-a-half (1.5) months

Employees on approved leaves of absence, modified-duty assignments, or transitional-duty assignments are expected to provide regular updates every 30 days to their Division's LDAC

Salt Lake City Police Department

SLCPD Policy Manual

SLCPD Policy Manual

Temporary Modified- and Transitional-Duty Assignments and Leaves of Absence

stating their expectation to return to full duty. At least 10 days prior to the conclusion of an approved LOA, modified-duty assignment, or transitional-duty assignment, employees shall provide their Division's LDAC medical documentation stating the date they are expected to be released to full duty. Upon release of all restrictions by the medical provider, the employee must complete the Return to Full Duty Release form prior to returning. Employees who do not provide such documentation, or do not provide an expected return to full duty date within the required time frames, may be separated from employment.

Employees seeking to apply for an extension to the time limits outlined above, where there are no other alternatives to either continued compensation or job protection, shall submit a request to their Division's LDAC at least 10 calendar days prior to the conclusion of the pertinent LOA, modified-duty assignment, or transitional-duty assignment. The request shall provide details regarding the rationale for such request and the time needed to return to full duty. The LDAC shall submit the request through the chain of command to the Chief of Police, or the Chief's designee. The employee will have an opportunity to present this request to a board comprised of the Fire Chief, the Police Chief, the Human Resources Director, and the Mayor's Chief of Staff, or their designee(s). This board will make a decision regarding the request for extension. In the event of a tied vote regarding the request for extension, the director of the employee's working department shall have the final deciding authority.

1025.5 PROCEDURE

Proper procedures shall be followed for temporary modified- and transitional-duty assignments.

[Salt Lake City Police Department Procedure Manual: 1008.2 PROCEDURE](#)

[Salt Lake City Police Department Procedure Manual: 1008.2.1 ACCOUNTABILITY](#)

[Salt Lake City Police Department Procedure Manual: 1008.2.2 EMPLOYEE RESPONSIBILITIES](#)

[Salt Lake City Police Department Procedure Manual: 1008.2.3 SUPERVISOR RESPONSIBILITIES](#)

[Salt Lake City Police Department Procedure Manual: 1008.2.4 MEDICAL EXAMINATIONS](#)

[Salt Lake City Police Department Procedure Manual: 1008.2.5 PREGNANCY](#)

[Salt Lake City Police Department Procedure Manual: 1008.2.6 PROBATIONARY EMPLOYEES](#)

[Salt Lake City Police Department Procedure Manual: 1008.2.7 MAINTENANCE OF CERTIFICATION AND TRAINING](#)

1025.6 REVISIONS

Enacted: May 14, 2018

Revised: May 21, 2018

Revised: September 7, 2018

Revised: April 5, 2019

Early Identification and Intervention Program

1026.1 PURPOSE AND SCOPE

The purpose of this policy is to outline a process regarding the management and utilization of the Department's Early Identification and Intervention Program (EIIP).

1026.1.1 DEFINITIONS

Early Identification and Intervention Program (EIIP) - The Department's proactive, non-disciplinary approach to identifying employees who may need assistance and to document actions taken to assist such employees.

Alert - A notification by the EIIP when an employee meets or exceeds a predetermined threshold within an established time frame.

Intervention- Assistance provided to the employee that may include, but is not limited to, training, counseling, a Performance Improvement Plan (see the Performance Improvement Plans Policy), and/or other referral.

1026.2 POLICY

It is the policy of this department to promote excellence by providing resources and tools to supervisors in assisting employees who are experiencing personal or professional problems which may affect performance on the job. The Early Identification and Intervention Program (EIIP) is committed to promoting employee success through non-disciplinary methods.

1026.2.1 GENERAL GUIDELINES

The EIIP identifies behavior which could lead to diminished work performance and/or undue stress to an employee. Early intervention is implemented through the employee's chain of command with support from the EIIP Coordinator, and occurs after an alert is generated. Intervention is based on the particular needs and input of the employee which may include counseling, training, and/or referral. In addition, the EIIP reduces liability and risk exposure to the employee as well as to the Department, and ensures supervisory accountability.

Supervisors are reminded that the EIIP is a supervisory/management tool that alerts when the number of record entries exceeds a predetermined threshold for the system. An alert is simply an indicator for supervisors and management to closely scrutinize the information that triggered the alert for that employee, analyze additional data if needed, and to take appropriate action. EIIP and all documentation is to be treated as confidential in nature. The EIIP shall not be accessed or used for the purpose of discipline, promotion, or when a member requests a transfer of special assignment. However, information that exists outside of and separate from the EIIP system may be used for the purpose of discipline, promotion, or when a member requests a transfer or special assignment, when appropriate and consistent with Department policies and procedures.

Salt Lake City Police Department

SLCPD Policy Manual

SLCPD Policy Manual

Early Identification and Intervention Program

1026.2.2 EARLY IDENTIFICATION COMPONENT

When an employee surpasses a determined threshold, an alert is generated and the EIIP process is initiated. The current indicators and thresholds utilized in the EIIP are as follows:

Indicators	Thresholds
Category 1 Complaints	2 in a rolling 12 month period
Category 2 Complaints	2 in a rolling 12 month period
M-Files	3 in a rolling 12 month period
Use-of-Force	The number of uses-of-force in a rolling 12 month period that is above the 2nd standard deviation for the previous calendar year (calculated by number of use-of-force incidents involving officers in the Operations Bureau)
Vehicle Collisions	2 in a rolling 12 month period
Vehicle Pursuits	2 in a rolling 12 month period
Firearm Discharge (other than an OICI and/or destruction of animals or wildlife)	2 in a rolling 24 month period
Overall	4 of any combination of the above (excluding uses-of-force) in a rolling 12 month period

The EIIP Coordinator will be notified by the Early Intervention software when an alert is generated for an employee. The EIIP Coordinator is responsible for confirming the alert conforms with the above thresholds and forwarding it to the employee's supervisor(s).

1026.2.3 EARLY INTERVENTION COMPONENT

Early intervention by the first-line supervisor is the key component of the EIIP. Supervisors are required to participate in an initial face-to-face discussion with the employee regarding the potential performance issue. If it is determined that there is a performance issue that needs to be corrected, the supervisor, in cooperation with the second-line supervisor, will conduct an intervention.

There are both mandatory and non-mandatory intervention types. If the intervention is due to a performance issue that can be corrected by remedial training, policy review, career counseling, or a Performance Improvement Plan, then the employee will be mandated to follow whatever course of action is directed by their first- and second-line supervisor (Professional Intervention). If the suggested intervention is personal in nature (e.g., peer support referral, EAP referral, police chaplain referral, voluntary leave) the employee is under no obligation to accept the offered intervention (Personal Intervention).

1026.2.4 ANNUAL EVALUATION

The EIIP Coordinator will submit an evaluation of the EIIP to the command staff on an annual basis.

1026.2.5 PROCEDURE

[Salt Lake City Police Department Procedure Manual: 1011.2.1 EIIP COORDINATOR](#)

[Salt Lake City Police Department Procedure Manual: 1011.2.2 FIRST-LINE SUPERVISOR](#)

[Salt Lake City Police Department Procedure Manual: 1011.2.3 SECOND-LINE SUPERVISOR](#)

Salt Lake City Police Department

SLCPD Policy Manual

SLCPD Policy Manual

Early Identification and Intervention Program

[Salt Lake City Police Department Procedure Manual: 1011.2.4 DIVISION COMMANDER](#)

1026.3 REVISIONS

Enacted: February 17, 2019

Employee Speech, Expression and Social Networking

1027.1 PURPOSE AND SCOPE

This policy is intended to address issues associated with employee use of social networking sites and to provide guidelines for the regulation and balancing of employee speech and expression with the needs of the Department.

Nothing in this policy is intended to prohibit or infringe upon any communication, speech or expression that is protected or privileged under law. This includes speech and expression protected under state or federal constitutions as well as labor or other applicable laws. For example, this policy does not limit an employee from speaking as a private citizen, including acting as an authorized member of a recognized bargaining unit or officer associations, about matters of public concern, such as misconduct or corruption.

Employees are encouraged to consult with their supervisor regarding any questions arising from the application or potential application of this policy.

1027.1.1 APPLICABILITY

This policy applies to all forms of communication including but not limited to film, video, print media, public or private speech, use of all Internet services, including the World Wide Web, e-mail, file transfer, remote computer access, news services, social networking, social media, instant messaging, blogs, forums, video and other file-sharing sites.

1027.2 POLICY

Public employees occupy a trusted position in the community, and thus, their statements have the potential to contravene the policies and performance of this department. Due to the nature of the work and influence associated with the law enforcement profession, it is necessary that employees of this department be subject to certain reasonable limitations on their speech and expression. To achieve its mission and efficiently provide service to the public, the Salt Lake City Police Department will carefully balance the individual employee's rights against the Department's needs and interests when exercising a reasonable degree of control over its employees' speech and expression.

1027.3 SAFETY

Employees should consider carefully the implications of their speech or any other form of expression when using the Internet. Speech and expression that may negatively affect the safety of the Salt Lake City Police Department employees, such as posting personal information in a public forum, can result in compromising an employee's home address or family ties. Employees should therefore not disseminate or post any information on any forum or medium that could reasonably be anticipated to compromise the safety of any employee, an employee's family or associates. Examples of the type of information that could reasonably be expected to compromise safety include:

Salt Lake City Police Department

SLCPD Policy Manual

SLCPD Policy Manual

Employee Speech, Expression and Social Networking

- Disclosing a photograph and name or address of an officer who is working undercover.
- Disclosing the address of a fellow officer.
- Otherwise disclosing where another officer can be located off-duty.

1027.4 PROHIBITED SPEECH, EXPRESSION AND CONDUCT

To meet the department's safety, performance and public-trust needs, the following are prohibited unless the speech is otherwise protected:

- (a) Speech or expression made pursuant to an official duty that tends to compromise or damage the mission, function, reputation or professionalism of the Salt Lake City Police Department or its employees.
- (b) Speech or expression that, while not made pursuant to an official duty, is significantly linked to, or related to, the Salt Lake City Police Department and tends to compromise or damage the mission, function, reputation or professionalism of the Salt Lake City Police Department or its employees. Examples may include:
 1. Statements that indicate disregard for the law or the state or U.S. Constitutions.
 2. Expression that demonstrates support for criminal activity.
 3. Participating in sexually explicit photographs or videos for compensation or distribution.
- (c) Speech or expression that could reasonably be foreseen as having a negative impact on the credibility of the employee as a witness. For example, posting statements or expressions to a website that glorify or endorse dishonesty, unlawful discrimination or illegal behavior.
- (d) Speech or expression of any form that could reasonably be foreseen as having a negative impact on the safety of the employees of the Department. For example, a statement on a blog that provides specific details as to how and when prisoner transportations are made could reasonably be foreseen as potentially jeopardizing employees by informing criminals of details that could facilitate an escape or attempted escape.
- (e) Speech or expression that is contrary to the canons of the Law Enforcement Code of Ethics as adopted by the Salt Lake City Police Department.
- (f) Use or disclosure, through whatever means, of any information, photograph, video or other recording obtained or accessible as a result of employment with the Department for financial or personal gain, or any disclosure of such materials without the express authorization of the Chief of Police or the authorized designee (Utah Code 67-16-4).
- (g) Posting, transmitting or disseminating any photographs, video or audio recordings, likenesses or images of department logos, emblems, uniforms, badges, patches, marked vehicles, equipment or other material that specifically identifies the Salt Lake City Police Department on any personal or social networking or other website or web page in a manner that tends to compromise or damage the mission, function, reputation or professionalism of the Salt Lake City Police Department or its employees.

Salt Lake City Police Department

SLCPD Policy Manual

SLCPD Policy Manual

Employee Speech, Expression and Social Networking

Employees must take reasonable and prompt action to remove any content, including content posted by others, that is in violation of this policy from any web page or website maintained by the employee (e.g., social or personal website).

1027.4.1 UNAUTHORIZED ENDORSEMENTS AND ADVERTISEMENTS

While employees are not restricted from engaging in the following activities as private citizens or as authorized members of a recognized bargaining unit or officer associations, employees may not represent the Salt Lake City Police Department or identify themselves in any way that could be reasonably perceived as representing the Salt Lake City Police Department in order to do any of the following, unless specifically authorized by the Chief of Police (Utah Code 20A-11-1206):

- (a) Endorse, support, oppose or contradict any political campaign or initiative.
- (b) Endorse, support, oppose or contradict any social issue, cause or religion.
- (c) Endorse, support or oppose any product, service, company or other commercial entity.
- (d) Appear in any commercial, social or nonprofit publication or any motion picture, film, video, public broadcast or any website.
- (e) Use the email of Salt Lake City Police Department for any political purpose (Utah Code 20A-11-1205).

Additionally, when it can reasonably be construed that an employee, acting in his/her individual capacity or through an outside group or organization (e.g. bargaining group), is affiliated with this department, the employee shall give a specific disclaiming statement that any such speech or expression related to Department and/or City business is not representative of the Salt Lake City Police Department or the City.

Employees retain their right to vote as they choose, to support candidates of their choice and to express their opinions as private citizens, including as authorized members of a recognized bargaining unit or officer associations, on political subjects and candidates at all times while off-duty. However, employees may not use their official authority or influence to interfere with or affect the result of an election or a nomination for office. Employees are also prohibited from directly or indirectly using their official authority to coerce, command or advise another employee to pay, lend or contribute anything of value to a party, committee, organization, agency or person for political purposes (5 USC § 1502).

1027.5 PRIVACY EXPECTATION

Employees forfeit any expectation of privacy with regard to e-mails, texts or anything published or maintained through file-sharing software or any Internet site (e.g., Facebook, Twitter) that is accessed, transmitted, received or reviewed on any department technology system.

The Department reserves the right to access, audit and disclose for whatever reason any message, including attachments, and any information accessed, transmitted, received or reviewed over any technology that is issued or maintained by the Department, including the department e-mail system, computer network or any information placed into storage on any department system or device. This includes records of all key strokes or web-browsing history made at any department

Salt Lake City Police Department

SLCPD Policy Manual

SLCPD Policy Manual

Employee Speech, Expression and Social Networking

computer or over any department network. The fact that access to a database, service or website requires a user name or password will not create an expectation of privacy if it is accessed through department computers or networks.

Except as authorized by the Office of the Chief of Police, all information gathered or obtained by employees through their Department positions is property of the Department and should be treated as private and confidential material. Revealing private or confidential information is inappropriate, reflects negatively on the Department, distracts from the mission of the Department, and may violate state and federal laws, rules or regulations.

1027.6 CONSIDERATIONS

In determining whether to grant authorization of any speech or conduct that is prohibited under this policy, the factors that the Chief of Police or authorized designee should consider include:

- (a) Whether the speech or conduct would negatively affect the efficiency of delivering public services.
- (b) Whether the speech or conduct would be contrary to the good order of the Department or the efficiency or morale of its members.
- (c) Whether the speech or conduct would reflect unfavorably upon the Department.
- (d) Whether the speech or conduct would negatively affect the member's appearance of impartiality in the performance of his/her duties.
- (e) Whether similar speech or conduct has been previously authorized.
- (f) Whether the speech or conduct may be protected and outweighs any interest of the Department.

1027.7 TRAINING

Subject to available resources, the Department should provide training regarding employee speech and the use of social networking to all members of the Department.

1027.8 REVISIONS

Enacted: May 14, 2018

Line-of-Duty Deaths

1028.1 PURPOSE AND SCOPE

The purpose of this policy is to provide guidance to members of the Salt Lake City Police Department in the event of the death of a member occurring in the line of duty and to direct the Department in providing proper support for the member's survivors.

The Chief of Police may also apply some or all of this policy in situations where members are injured in the line of duty and the injuries are life-threatening.

1028.1.1 DEFINITIONS

Definitions related to this policy include:

Line-of-duty death - The death of a sworn member during the course of performing law enforcement-related functions while on- or off-duty, or a non-sworn member during the course of performing their assigned duties.

Survivors - Immediate family members of the deceased member, which can include spouse, children, parents, other next of kin or significant others. The determination of who should be considered a survivor for purposes of this policy should be made on a case-by-case basis given the individual's relationship with the member and whether the individual was previously designated by the deceased member.

1028.2 POLICY

It is the policy of the Salt Lake City Police Department to make appropriate notifications and to provide assistance and support to survivors and coworkers of a member who dies in the line of duty.

It is also the policy of this department to respect the requests of the survivors when they conflict with these guidelines, as appropriate.

1028.3 INITIAL ACTIONS BY COMMAND STAFF

- (a) Upon learning of a line-of-duty death, the deceased member's supervisor should provide all reasonably available information to the Watch Commander and Dispatch.
 1. Communication of information concerning the member and the incident should be restricted to secure networks to avoid interception by the media or others (see the Public Information Officer section of this policy).
- (b) The Watch Commander should ensure that notifications are made in accordance with the Officer-Involved Shootings and Deaths and Major Incident Notification policies as applicable.
- (c) If the member has been transported to the hospital, the Watch Commander or the designee should respond to the hospital to assume temporary responsibilities as the Hospital Liaison.

Salt Lake City Police Department

SLCPD Policy Manual

SLCPD Policy Manual

Line-of-Duty Deaths

- (d) The Chief of Police or the authorized designee should assign members to handle survivor notifications and assign members to the roles of Hospital Liaison (to relieve the temporary Hospital Liaison) and the Department Liaison as soon as practicable (see the Notifying Survivors section and the Department Liaison and Hospital Liaison subsections in this policy).

1028.4 NOTIFYING SURVIVORS

Survivors should be notified as soon as possible in order to avoid the survivors hearing about the incident in other ways.

The Chief of Police or the authorized designee should review the deceased member's emergency contact information and make accommodations to respect the member's wishes and instructions specific to notifying survivors. However, notification should not be excessively delayed because of attempts to assemble a notification team in accordance with the member's wishes.

The Chief of Police, Watch Commander or the authorized designee should select at least two members to conduct notification of survivors, one of which may be the Department Chaplain.

Notifying members should:

- (a) Make notifications in a direct and compassionate manner, communicating as many facts of the incident as possible, including the current location of the member. Information that is not verified should not be provided until an investigation has been completed.
- (b) Determine the method of notifying surviving children by consulting with other survivors and taking into account factors such as the child's age, maturity and current location (e.g., small children at home, children in school).
- (c) Plan for concerns such as known health concerns of survivors or language barriers.
- (d) Offer to transport survivors to the hospital, if appropriate. Survivors should be transported in department vehicles. Notifying members shall inform the Hospital Liaison over a secure network that the survivors are on their way to the hospital and should remain at the hospital while the survivors are present.
- (e) When survivors are not at their residences or known places of employment, actively seek information and follow leads from neighbors, other law enforcement, postal authorities and other sources of information in order to accomplish notification in as timely a fashion as possible. Notifying members shall not disclose the reason for their contact other than a family emergency.
- (f) If making notification at a survivor's workplace, ask a workplace supervisor for the use of a quiet, private room to meet with the survivor. Members shall not inform the workplace supervisor of the purpose of their visit other than to indicate that it is a family emergency.
- (g) Offer to call other survivors, friends or clergy to support the survivors and to avoid leaving survivors alone after notification.
- (h) Assist the survivors with meeting childcare or other immediate needs.

Salt Lake City Police Department

SLCPD Policy Manual

SLCPD Policy Manual

Line-of-Duty Deaths

- (i) Care should be taken not to make promises or commitments to survivors that cannot be met.
- (j) Inform the survivors of the name and phone number of the Survivor Support Liaison (see the Survivor Support Liaison section of this policy), if known, and the Department Liaison.
- (k) Provide their contact information to the survivors before departing.
- (l) Document the survivor's names and contact information, as well as the time and location of notification. This information should be forwarded to the Department Liaison.
- (m) Inform the Chief of Police or the authorized designee once survivor notifications have been made so that other Salt Lake City Police Department members may be apprised that survivor notifications are complete.
- (n) Department Personnel not specifically assigned to make notification will not contact next of kin until the formal notification has been made.

1028.4.1 OUT-OF-AREA NOTIFICATIONS

The Department Liaison should request assistance from law enforcement agencies in appropriate jurisdictions for in-person notification to survivors who are out of the area.

- (a) The Department Liaison should contact the appropriate jurisdiction using a secure network and provide the assisting agency with the name and telephone number of the department member that the survivors can call for more information following the notification by the assisting agency.
- (b) The Department Liaison may assist in making transportation arrangements for the member's survivors, but will not obligate the Department to pay travel expenses without the authorization of the Chief of Police.

1028.5 NOTIFYING DEPARTMENT MEMBERS

Supervisors or members designated by the Chief of Police are responsible for notifying department members of the line-of-duty death as soon as possible after the survivor notification is made. Notifications and related information should be communicated in person or using secure networks and should not be transmitted over the radio.

1028.6 LIAISONS AND COORDINATORS

The Chief of Police or the authorized designee should select members to serve as liaisons and coordinators to handle responsibilities related to a line-of-duty death, including, but not limited to:

- (a) Department Liaison.
- (b) Hospital Liaison.
- (c) Survivor Support Liaison.
- (d) Peer Support Team Leader(s).
- (e) Funeral Liaison.
- (f) Mutual aid coordinator.

Salt Lake City Police Department

SLCPD Policy Manual

SLCPD Policy Manual

Line-of-Duty Deaths

- (g) Benefits Liaison.
- (h) Finance coordinator.

Liaisons and coordinators will be directed by the Department Liaison and should be given sufficient duty time to complete their assignments.

Members may be assigned responsibilities of more than one liaison or coordinator position depending on available department resources. The Department Liaison may assign separate liaisons and coordinators to accommodate multiple family units if needed.

1028.6.1 DEPARTMENT LIAISON

The Department Liaison should be a Division Commander or of sufficient rank to effectively coordinate department resources and should serve as a facilitator between the deceased member's survivors and the Department. The Department Liaison reports directly to the Chief of Police. The Department Liaison's responsibilities include, but are not limited to:

- (a) Directing the other liaisons and coordinators in fulfilling survivors' needs and requests. Consideration should be given to organizing the effort using the National Incident Management System (NIMS).
- (b) Establishing contact with survivors within 24 hours of the incident and providing involved parties with necessary contact information.
- (c) Advising survivors of the other liaison and coordinator positions and their roles and responsibilities.
- (d) Identifying locations that will accommodate a law enforcement funeral and presenting the options to the appropriate survivors, who will select the location.
- (e) Coordinating all official law enforcement notifications and arrangements.
- (f) Making necessary contacts for authorization to display flags at half-mast.
- (g) Ensuring that department members are reminded of appropriate information—sharing restrictions regarding the release of information that could undermine future legal proceedings.
- (h) Coordinating security checks of the member's residence as necessary and reasonable.
- (i) Serving as a liaison with visiting law enforcement agencies during memorial and funeral services.

1028.6.2 HOSPITAL LIAISON

The Hospital Liaison should work with hospital personnel to:

- (a) Arrange for appropriate and separate waiting areas for:
 1. The survivors and others whose presence is requested by the survivors.
 2. Department members and friends of the deceased member.
 3. Media personnel.

Salt Lake City Police Department

SLCPD Policy Manual

SLCPD Policy Manual

Line-of-Duty Deaths

- (b) Ensure, as much as practicable, that any suspects who are in the hospital and their families or friends are not in close proximity to the member's survivors or Salt Lake City Police Department members (except for members who may be guarding the suspect).
- (c) Ensure that survivors receive timely updates regarding the member before information is released to others.
- (d) Arrange for survivors to have private time with the member, if requested.
 - 1. The Hospital Liaison or hospital personnel may need to explain the condition of the member to the survivors to prepare them accordingly.
 - 2. The Hospital Liaison should accompany the survivors into the room, if requested.
- (e) Stay with survivors and ensure that they are provided with other assistance as needed at the hospital.
- (f) If applicable, explain to the survivors why an autopsy may be needed.
- (g) Ensure hospital bills are directed to the Department, that the survivors are not asked to sign as guarantor of payment for any hospital treatment and that the member's residence address, insurance information and next of kin are not included on hospital paperwork.

Other responsibilities of the Hospital Liaison include, but are not limited to:

- Arranging transportation for the survivors back to their residence.
- Working with investigators to gather and preserve the deceased member's equipment and other items that may be of evidentiary value.
- Documenting his/her actions at the conclusion of his/her duties.

1028.6.3 SURVIVOR SUPPORT LIAISON

The Survivor Support Liaison should work with the Department Liaison to fulfill the immediate needs and requests of the survivors of any member who has died in the line of duty, and serve as the long-term department contact for survivors.

The Survivor Support Liaison should be selected by the deceased member's Division Commander.

The following should be considered when selecting the Survivor Support Liaison:

- The liaison should be an individual the survivors know and with whom they are comfortable working.
- If the survivors have no preference, the selection may be made from names recommended by the deceased member's supervisor and/or coworkers. The deceased member's partner or close friends may not be the best selections for this assignment because the emotional connection to the member or survivors may impair their ability to conduct adequate liaison duties.
- The liaison must be willing to assume the assignment with an understanding of the emotional and time demands involved.

The responsibilities of the Survivor Support Liaison include, but are not limited to:

Salt Lake City Police Department

SLCPD Policy Manual

SLCPD Policy Manual

Line-of-Duty Deaths

- (a) Arranging for transportation of survivors to hospitals, places of worship, funeral homes and other locations, as appropriate.
- (b) Communicating with the Department Liaison regarding appropriate security measures for the family residence, as needed.
- (c) If requested by the survivors, providing assistance with instituting methods of screening telephone calls made to their residence after the incident.
- (d) Providing assistance with travel and lodging arrangements for out-of-town survivors.
- (e) Returning the deceased member's personal effects from the Department and the hospital to the survivors. The following should be considered when returning the personal effects:
 - 1. Items should not be delivered to the survivors until they are ready to receive the items.
 - 2. Items not retained as evidence should be delivered in a clean, unmarked box.
 - 3. All clothing not retained as evidence should be cleaned and made presentable (e.g., items should be free of blood or other signs of the incident).
 - 4. The return of some personal effects may be delayed due to ongoing investigations.
- (f) Assisting with the return of department-issued equipment that may be at the deceased member's residence.
 - 1. Unless there are safety concerns, the return of the equipment should take place after the funeral at a time and in a manner considerate of the survivors' wishes.
- (g) Working with the Peer Support Team Leader(s) to ensure that survivors have access to available counseling services.
- (h) Coordinating with the department's Public Information Officer (PIO) to brief the survivors on pending press releases related to the incident and to assist the survivors with media relations in accordance with their wishes (see the Public Information Officer section of this policy).
- (i) Briefing survivors on investigative processes related to the line-of-duty death, such as criminal, internal and administrative investigations.
- (j) Informing survivors of any related criminal proceedings and accompanying them to such proceedings.
- (k) Introducing survivors to prosecutors, victim assistance personnel and other involved personnel as appropriate.
- (l) Maintaining long-term contact with survivors and taking measures to sustain a supportive relationship (e.g., follow-up visits, phone calls, cards on special occasions, special support during holidays).
- (m) Inviting survivors to department activities, memorial services or other functions as appropriate.

Salt Lake City Police Department

SLCPD Policy Manual

SLCPD Policy Manual

Line-of-Duty Deaths

Survivor Support Liaisons providing services after an incident resulting in multiple members being killed should coordinate with and support each other through conference calls or meetings as necessary.

The Department recognizes that the duties of a Survivor Support Liaison will often affect regular assignments over many years, and is committed to supporting members in the assignment.

If needed, the Survivor Support Liaison should be issued a personal communication device (PCD) owned by the Department to facilitate communications necessary to the assignment. The department-issued PCD shall be used in accordance with the Personal Communication Devices Policy.

1028.6.4 PEER SUPPORT TEAM LEADER(S)

The Peer Support Team Leader(s) should work with the Chief of Police or the authorized designee, liaisons, coordinators and other resources to make Peer Support and counseling services available to members and survivors who are impacted by a line-of-duty death. The responsibilities of the Peer Support Team Leader(s) include, but are not limited to:

- (a) Identifying members who are likely to be significantly affected by the incident and may have an increased need for Peer Support and counseling services, including:
 - (a) Members involved in the incident.
 - (b) Members who witnessed the incident.
 - (c) Members who worked closely with the deceased member but were not involved in the incident.
- (b) Ensuring that members who were involved in or witnessed the incident are relieved of department responsibilities until they can receive Peer Support as appropriate and possible.
- (c) Ensuring that Peer Support and counseling resources (e.g., peer support, debriefing, grief counselors) are available to members as soon as reasonably practicable following the line-of-duty death.
- (d) Coordinating with the Survivor Support Liaison to ensure survivors are aware of available Peer Support and counseling services and assisting with arrangements as needed.
- (e) Following up with members and the Survivor Support Liaison in the months following the incident to determine if additional Peer Support or counseling services are needed.

1028.6.5 FUNERAL LIAISON

The Funeral Liaison should work with the Department Liaison, Survivor Support Liaison and survivors to coordinate funeral arrangements to the extent the survivors wish. The Funeral Liaison's responsibilities include, but are not limited to:

- (a) Assisting survivors in working with the funeral director regarding funeral arrangements and briefing them on law enforcement funeral procedures.
- (b) Completing funeral notification to other law enforcement agencies.

Salt Lake City Police Department

SLCPD Policy Manual

SLCPD Policy Manual

Line-of-Duty Deaths

- (c) Coordinating the funeral activities of the Department, including, but not limited to the following:
 - 1. Honor Guard
 - (a) Casket watch
 - (b) Color guard
 - (c) Pallbearers
 - (d) Rifle salute
 - 2. Bagpipers/bugler
 - 3. Uniform for burial
 - 4. Flag presentation
 - 5. Last radio call
- (d) Briefing the Chief of Police and command staff concerning funeral arrangements.
- (e) Assigning an officer to remain at the family home during the viewing and funeral.
- (f) Arranging for transportation of the survivors to and from the funeral home and interment site using department vehicles and drivers.

1028.6.6 MUTUAL AID COORDINATOR

The mutual aid coordinator should work with the Department Liaison and the Funeral Liaison to request and coordinate any assistance from outside law enforcement agencies needed for, but not limited to:

- (a) Traffic control during the deceased member's funeral.
- (b) Area coverage so that as many Salt Lake City Police Department members can attend funeral services as possible.

The mutual aid coordinator should perform his/her duties in accordance with the Outside Agency Assistance Policy.

1028.6.7 BENEFITS LIAISON

The Department's Human Resources Consultant will be the Benefits Liaison. They will work in conjunction with the City's Human Resources Office and the Department's Personnel Payroll Administrator.

The Benefits Liaison should provide survivors with information concerning available benefits and assist them in applying for benefits. Responsibilities of the Benefits Liaison include, but are not limited to:

- (a) Confirming the filing of workers compensation claims and related paperwork (see the Occupational Disease and Work-Related Injury Reporting Policy).
- (b) Researching and assisting survivors with applications for federal government survivor benefits, such as those offered through the:

Salt Lake City Police Department

SLCPD Policy Manual

SLCPD Policy Manual

Line-of-Duty Deaths

- (a) Public Safety Officers' Benefits (PSOB) Programs.
- (b) Public Safety Officers' Educational Assistance (PSOEA) Program.
- (c) Social Security Administration.
- (d) Department of Veterans Affairs.
- (c) Researching and assisting survivors with applications for state and local government survivor benefits.
 - 1. Death benefits available under Title 49, Utah State Retirement and Insurance Benefit Act
 - 2. Health coverage benefits (Utah Code 53-17-201)
 - 3. Death benefit assistance (Utah Code 53-17-501)
 - 4. Educational benefits (Utah Code 53B-8c-103)
- (d) Researching and assisting survivors with applications for other survivor benefits such as:
 - 1. Private foundation survivor benefits programs.
 - 2. Survivor scholarship programs.
- (e) Researching and informing survivors of support programs sponsored by police associations and other organizations.
- (f) Documenting and informing survivors of inquiries and interest regarding public donations to the survivors.
 - 1. If requested, working with the finance coordinator to assist survivors with establishing a process for the receipt of public donations.
- (g) Providing survivors with a summary of the nature and amount of benefits applied for, including the name of a contact person at each benefit office. Printed copies of the summary and benefit application documentation should be provided to affected survivors.
- (h) Maintaining contact with the survivors and assisting with subsequent benefit questions and processes as needed.

1028.6.8 FINANCE COORDINATOR

The finance coordinator should work with the Chief of Police and the Department Liaison to manage financial matters related to the line-of-duty death. The finance coordinator's responsibilities include, but are not limited to:

- (a) Establishing methods for purchasing and monitoring costs related to the incident.
- (b) Providing information on finance-related issues, such as:
 - 1. Paying survivors' travel costs if authorized.
 - 2. Transportation costs for the deceased.
 - 3. Funeral and memorial costs.

Salt Lake City Police Department

SLCPD Policy Manual

SLCPD Policy Manual

Line-of-Duty Deaths

4. Related funding or accounting questions and issues.
- (c) Working with the Benefits Liaison to establish a process for the receipt of public donations to the deceased member's survivors.
- (d) Providing accounting and cost information as needed.

1028.7 PUBLIC INFORMATION OFFICER

In the event of a line-of-duty death, the department's PIO should be the department's contact point for the media. As such, the PIO should coordinate with the Department Liaison to:

- (a) Collect and maintain the most current incident information and determine what information should be released.
- (b) Ensure that department members are instructed to direct any media inquiries to the PIO.
- (c) Prepare necessary press releases.
 1. Ensure coordination with other entities having media roles (e.g., outside agencies involved in the investigation or incident).
 2. Ensure that important public information is disseminated, such as information on how the public can show support for the Department and deceased member's survivors.
- (d) Arrange for community and media briefings by the Chief of Police or the authorized designee as appropriate.
- (e) Respond, or coordinate the response, to media inquiries.
- (f) If requested, assist the member's survivors with media inquiries.
 1. Brief the survivors on handling sensitive issues such as the types of questions that reasonably could jeopardize future legal proceedings.
- (g) Release information regarding memorial services and funeral arrangements to department members, other agencies and the media as appropriate.
- (h) If desired by the survivors, arrange for the recording of memorial and funeral services via photos and/or video.

The identity of deceased members should be withheld until the member's survivors have been notified. If the media has obtained identifying information for the deceased member prior to survivor notification, the PIO should request that the media withhold the information from release until proper notification can be made to survivors. The PIO should ensure that media are notified when survivor notifications have been made.

1028.8 DEPARTMENT CHAPLAIN

The Department chaplain may serve a significant role in line-of-duty deaths. His/her duties may include, but are not limited to:

- Assisting with survivor notifications and assisting the survivors with counseling, emotional support or other matters, as appropriate.

Salt Lake City Police Department

SLCPD Policy Manual

SLCPD Policy Manual

Line-of-Duty Deaths

- Assisting liaisons and coordinators with their assignments, as appropriate.
- Assisting department members with counseling or emotional support, as requested and appropriate.

Further information on the potential roles and responsibilities of the chaplain is in the Chaplains Policy.

1028.9 INVESTIGATION OF THE INCIDENT

The Chief of Police shall ensure that line-of-duty deaths are investigated thoroughly and may choose to use the investigation process outlined in the Officer-Involved Shootings and Deaths Policy.

Investigators from other agencies may be assigned to work on any criminal investigation related to line-of-duty deaths. Partners, close friends or personnel who worked closely with the deceased member should not have any investigative responsibilities because such relationships may impair the objectivity required for an impartial investigation of the incident.

Involved department members should be kept informed of the progress of the investigations and provide investigators with any information that may be pertinent to the investigations.

1028.10 LINE-OF-DUTY DEATH OF A LAW ENFORCEMENT ANIMAL

The Chief of Police may authorize appropriate memorial and funeral services for law enforcement animals killed in the line of duty.

1028.11 NON-LINE-OF-DUTY DEATH

The Chief of Police may authorize certain support services for the death of a member not occurring in the line of duty.

1028.12 REVISIONS

Enacted: May 14, 2018

Revised: December 7, 2018

Employee Wellness and Support Program

1029.1 PURPOSE AND SCOPE

This policy outlines the Department's Employee Wellness and Support Program, Salt Lake City's Employee Assistance Program (EAP), and other wellness benefits available to employees.

1029.2 EMPLOYEE WELLNESS AND SUPPORT PROGRAM

The Employee Wellness and Support Program facilitates access to wellness programs and initiatives, including but not limited to mental health resources.

The Employee Wellness and Support Program is an elective and voluntary program operated by the department for the purpose of providing assistance to department employees, retirees, and their families as further provided herein. Engagement and participation with the Employee Wellness and Support Program is elective and an employee's engagement or participation can be voluntarily terminated by the employee at any time.

Employee Wellness and Support Program Personnel may include:

- An Employee Wellness and Support Program Coordinator, designated by the Chief;
- One or more full-time Wellness Program Facilitator(s), designated by the Employee Wellness and Support Program Coordinator;
- A team of collateral department employees/volunteers available to assist the Wellness Program Facilitator(s), designated by the Employee Wellness and Support Program Coordinator;
- One or more Mental Health Clinicians, designated by the Chief;
- A Chaplain Coordinator is designated by the Chief.

The Employee Wellness and Support Program may be comprised of sworn and/or non-sworn police department employees who have been specifically trained to assist in mental health symptoms, stress, and crises. Unless properly certified or licensed, Employee Wellness and Support Program Personnel are prohibited from and should not perform the duties of or otherwise act as counselors, therapists, or mental health professionals.

1029.2.1 ORGANIZATION CHART

1029.2.2 DEFINITIONS

Chaplains -one or more volunteers designated by the Chaplain Program Coordinator who provide emotional, moral, and spiritual support to department members, retirees, and/or their families.

Chaplain Program Coordinator - an individual, designated by the Chief, who maintains a cadre of Chaplains and works directly with the Employee Wellness and Support Program Coordinator. The Chaplain Program Coordinator is a Chaplain.

Salt Lake City Police Department

SLCPD Policy Manual

SLCPD Policy Manual

Employee Wellness and Support Program

Employee Wellness and Support Program Coordinator - an individual, designated by and who reports directly to the Chief, who helps to oversee the Employee Wellness and Support Program as further provided herein.

Employee Wellness and Support Program Personnel - sworn and/or non-sworn department employees who have been specifically trained to assist in dealing with mental health symptoms, stress, and crisis and who have been appropriately designated as such by the Employee Wellness and Support Program Coordinator. An Employee Wellness and Support Program Coordinator, Wellness Program Facilitator, Peer Support Program Facilitator, Mental Health Clinician, and Chaplains are all considered Employee Wellness and Support Program Personnel.

Good Standing - the department member meets the requirements for a transfer as provided by [Salt Lake City Police Department Policy Manual: 1002.3.2 DISQUALIFICATIONS](#).

Mental Health Clinician - a mental health clinician who is designated by the Chief and meets the minimum qualifications as outlined in the applicable job description.

Peer - any department employee, retiree, and/or family member(s) who engages or participates in any benefit program falling within the scope of the Employee Wellness Program.

Program Activity Log - the document, which should include bi-weekly summaries of contact types and service trends, which a Wellness Program Facilitator uses to track and record overall program usage by employees and referrals to provided benefits. This activity log may include the date the contact is initiated, benefits or programs to which the employee was referred, or the number of employees who attended or participated in covered wellness programs. The Program Activity Log shall not include personal identifying information pertaining to those utilizing the Employee Wellness and Support Program.

Wellness Program Facilitator(s) - an individual who reports to and is designated by the Employee Wellness and Support Program Coordinator. The role of the Wellness Program Facilitator is to plan, guide, and facilitate, with guidance from the Employee Wellness and Support Program Coordinator, all department-sponsored wellness programs and initiatives.

1029.3 ETHICAL ISSUES

1029.3.1 PRIVACY AND CONFIDENTIALITY

The personal integrity of Wellness and Support Program Personnel is paramount. At all times Wellness and Support Program Personnel will demonstrate respect for the dignity, personal welfare, and personally protected information of the individual receiving services or benefits falling within the scope of the Employee Wellness and Support Program. In the course of performing their duties, Wellness and Support Program Personnel may have access to personal, private, and sensitive information and all such information is to be safeguarded and should not be disclosed unless immediately necessary to preserve life, in compliance with applicable law, or with the written consent of the individual receiving services or benefits.

Salt Lake City Police Department

SLCPD Policy Manual

SLCPD Policy Manual

Employee Wellness and Support Program

1029.4 WELLNESS PROGRAM FACILITATOR(S) SELECTION, REMOVAL, AND LEAVE

Wellness Program Facilitator(s) must be in Good Standing with the department. Wellness Program Facilitators will be selected by the Employee Wellness and Support Program Coordinator, after consultation with the Chief, following policy 1002.3.3.

A Wellness Program Facilitator serves in that capacity at the pleasure of the Employee Wellness and Support Program Coordinator and may be removed from that assignment following the guidelines provided in [Salt Lake City Police Department Policy Manual: 1002.4 REASSIGNMENTS](#). However, breaches of confidentiality, failure to attend training, failure to keep current on best practices and programming, and/or loss of Good Standing within the department may result in the removal of a Wellness Program Facilitator from their duties. Removal of an individual from the assignment of Wellness Program Facilitator will be at the discretion of the Employee Wellness and Support Program Coordinator after consultation with the Chief or his/her designee.

1029.5 COORDINATOR AND FACILITATOR RESPONSIBILITIES

1029.5.1 EMPLOYEE WELLNESS AND SUPPORT PROGRAM COORDINATOR RESPONSIBILITIES

The Employee Wellness and Support Program Coordinator will actively endeavor to resolve departmental issues and conflicts related to the Employee Wellness and Support Program. S/he is tasked with training Employee Wellness and Support Program Personnel and monitoring their compliance with this policy. Communication with Peer Support Sergeants and Facilitators will occur at the monthly Chief's update and supervisor meeting. The Employee Wellness and Support Program Coordinator is also tasked with conducting or designating a facilitator to conduct Peer Support Program Personnel wellness checks.

The Employee Wellness and Support Program Coordinator will coordinate with the Wellness Program Facilitators and Mental Health Clinician regularly to identify needs. Needs may include but are not limited to helping with coordinating training, helping with other logistical problems, and helping with the administrative needs of the Wellness & Support team. The Employee Wellness and Support Program Coordinator will assist the Wellness Program Facilitators and Mental Health Clinician with matters including but not limited to time keeping, scheduling mandatory training, monitoring required training hours, and other administrative needs. The Employee Wellness and Support Program Coordinator will also be responsible for notifying the Department's HR business partner in cases where information that becomes known in the course of an individual's receipt of services or benefits falling within the scope of the Employee Wellness Program may impact the employment status of a department member.

1029.5.2 WELLNESS PROGRAM FACILITATOR RESPONSIBILITIES

The Wellness Program Facilitator is a full-time position that facilitates and communicates information about wellness programs and initiatives to Peers. The Wellness Program Facilitator will track, and provide updates on current wellness programs within the department. They will work with the Peer Support Team to identify the needs of Peers within the department and will

Salt Lake City Police Department

SLCPD Policy Manual

SLCPD Policy Manual

Employee Wellness and Support Program

develop training or programs to meet those needs. S/he will provide updates in the monthly Chief's update and supervisor meeting. The Wellness Program Facilitator will be responsible for compiling the Program Activity Log. The Program Activity Log will be used by Peer Support and Wellness Program Facilitators to track contacts and hours logged by personnel.

When available to do so, the Wellness Program Facilitator may assist the Peer Support Program Facilitator when help is requested, or when specifically directed by the Employee Wellness and Support Program Coordinator.

1029.6 DEPARTMENTAL MENTAL HEALTH CLINICIAN

This position, if filled by a department employee, will be held by a qualified applicant who meets the minimum requirements outlined in the job description, and will serve as an available resource within the department for employees and retirees. The Mental Health Clinician will, in accordance with any applicable standards of care, including any state licensing requirements, provide evidence-based mental health assessments, training, individual counseling, group counseling, critical incident stress debriefings, and resources to sworn and non-sworn department employees. Emergency counseling may be requested as needs arise. The Mental Health Clinician will notify the Employee Wellness and Support Program Coordinator when being called out for emergencies.

The Mental Health Clinician is not a Peer Support team member. S/he reports directly to the Employee Wellness and Support Program Coordinator. The Mental Health Clinician is a resource and may offer consultation to the Peer Support Program upon request from a Peer Support Sergeant and with the approval of the Employee Wellness and Support Program Coordinator. The Mental Health Clinician will compile monthly anonymized statistics and report them during the monthly Chief's update and supervisor meeting. Any requests or decisions regarding unscheduled leave that could impact an employee's ability to work their scheduled duty shift and/or modifications to their regular job duties (for example FMLA, modified duty, business adjustment, etc.), shall not be addressed or made by the Mental Health Clinician. Rather, any such request or decision coming to the Mental Health Clinician shall be referred to the Employee Wellness and Support Coordinator.

1029.7 EMPLOYEE WELLNESS BENEFITS

Salt Lake City has changed the way we look at wellness. Please take advantage of the wellness programs created with our city partners. They are provided below. Further questions or inquiries can be made directly to City HR, as well.

1029.7.1 THE EMPLOYEE ASSISTANCE PROGRAM (EAP)

The Employee Assistance Program (EAP) is a professional, confidential counseling service paid for by the City. The EAP allows a certain number of visits per issue, per year for covered participants. EAP services are administered through a third-party service that specializes in coordinating this type of program.

The EAP provides voluntary psychological and counseling services to all regular full and part-time employees, along with their spouses, dependent children, and mutual commitment relationship

Salt Lake City Police Department

SLCPD Policy Manual

SLCPD Policy Manual

Employee Wellness and Support Program

partners (as defined by the City) in dealing with stress and stress-related issues. The EAP also provides access to financial information and resources, legal support, and life guidance. Eligible employees can utilize the EAP by going online to: [Guidanceresources.com](https://www.guidanceresources.com).

1029.7.2 SLC STRONG

SLC STRONG is the city's dedicated Employee Assistance Program for Public Safety employees and their families. It is provided by a confidential third party, ComPsych, but offers unique benefits tailored to first responders and their needs. SLC Strong also has a dedicated Clinical Advisor who provides training to first responder departments in the City for up to 35 hours per month. This provider shares this monthly time between the Police Department, Fire Department, and 911 Communications Bureau.

Eligible employees wanting to utilize this service should refer to the City's Human Resources website located at [SLC-strong](https://www.slcstrong.com).

SLC360 provides opportunities for employees to proactively care for themselves and their families so they can better serve the citizens of Salt Lake City. Enrollment in SLC360 is tied to enrollment in the City's medical insurance program and follows the medical insurance plan year. The program incorporates physical health, mental health, financial wellness, and sustainability. Many different types of voluntary incentive challenges are available such as: participating in annual medical screenings, mental health challenges, exercise and diet-related challenges, and financial challenges as well as the ability to create custom challenges for each department. SLC360 is a points-based program that allows employees and their spouses to cash out up to \$150 of gift cards each annually for their participation in different challenges. Go to the attached link for further details: [SLC 360 Wellright](https://www.slc360wellright.com).

1029.7.3 MIDTOWN EMPLOYEE CLINIC

Midtown Employee Clinic is exclusively for Salt Lake City Corporation and Utah Retirement Systems Employees and their dependents covered by PEHP. This full-service, private clinic provides all the services of a family doctor but at a lower cost. It offers low copays after deductibles and significant discounts on all services. Midtown Clinic also provides access to trauma-certified therapists in the clinic who have significant experience with first responders. Their services follow the EAP model of 15 sessions per year.

Hours of operation: Monday thru Friday 8:30 am – 5:00 pm

Midtown Clinic

500 East 230 South, Suite 510

801-320-5660

<https://onsitecareclinics.com/>

Salt Lake City Police Department

SLCPD Policy Manual

SLCPD Policy Manual

Employee Wellness and Support Program

1029.7.4 RETIREMENT

Retirement information can be found at www.urs.org. There are step-by-step instructions located on the City website (<https://www.slc.gov/hr/benefits-and-wellness/retirement/>) regarding retirement.

1029.7.5 TUITION REIMBURSEMENT PROGRAM

The Tuition Reimbursement Program offers an employee a 100% reimbursement of up to \$4,000 per calendar year for tuition at an accredited institution, fees for approved coursework, and books. Forms requesting this benefit can be completed in Workday. If you have any questions, please reach out to tuitionreimbursement@slcgov.com.

1029.7.6 OTHER BENEFITS

Other benefits are available to SLC employees and can be found by visiting <https://slcity.corestream.com/>. The first time you access this site you will need to enroll with your employee ID, which can be found on your pay stub in Workday. These benefits include vision care, Hyatt legal, accident insurance, critical illness insurance, hospital indemnity insurance, auto and home insurance, discount shopping, financial wellness, identity theft protection, pet insurance, short-term loans, and hearing care. Please note: Some of these benefits can only be enrolled in during annual benefit enrollment.

1029.8 REVISIONS

Enacted: May 14, 2018

Revised: June 21, 2018

Revised: September 7, 2018

Revised: May 30, 2019

Revised: July 5, 2022

Revised: October 25, 2023

Secondary and Outside Employment

1030.1 PURPOSE AND SCOPE

This policy provides guidelines and requirements to Department members engaging in secondary and outside employment.

1030.1.1 DEFINITIONS

Secondary Employment – Off-duty employment requiring the use or potential use of police authority. By definition, only sworn officers can engage in secondary employment as referenced in this policy.

Outside Employment – Off-duty employment by a Department member that does not require the actual or potential use of police authority. This includes self-employment, contracting, sales jobs, etc.

Restricted Secondary Employment Jobs – Secondary employment jobs at which only specific officers are authorized to work.

Non-Restricted Secondary Employment Jobs – Secondary employment jobs at which all eligible sworn officers are authorized to work.

City-Contracted Secondary Employment - Secondary employment jobs at City-owned facilities or involving City overtime where the payment to officers is processed through City payroll.

Police Services Coordinator (PSC) – The member within the Police Financial Unit that is responsible for the scheduling and billing of secondary employment jobs.

Point of Contact Officer (POC) – The officer who facilitates communication between a restricted secondary employer and the PSC. The POC must be employed by the Department as a sworn officer. A POC is required for each restricted secondary employment job. The employer typically designates the POC. POC's do not have the ability to hire and/or fire individual officers for the restricted job they are the POC over.

Secondary Employment Lieutenant – The sworn member, holding the rank of Lieutenant, who manages the secondary employment program. The Secondary Employment Lieutenant maintains full discretionary authority over secondary employment matters on behalf of the Chief of Police. The current Secondary Employment Lieutenant is the Motor/Special Events Lieutenant.

POSE – The software program that officers use to sign up for secondary employment shifts.

Department-Directed Overtime – City paid overtime shifts where officers are directed, or can be directed, to work. Examples of Department-directed overtime include special events, tactical alerts, call-outs, etc. Department-directed overtime does not include voluntary overtime shifts such as non-mandatory patrol coverage.

Salt Lake City Police Department

SLCPD Policy Manual

SLCPD Policy Manual

Secondary and Outside Employment

1030.2 POLICY

It is the policy of the Salt Lake City Police Department to allow sworn personnel to engage in approved secondary employment opportunities within the guidelines/restrictions outlined herein. Working secondary employment is a privilege and not a right.

The Department does not prohibit personnel from outside employment, contracting, or running a personal business, provided it does not negatively impact an employee's Department position.

Officers engaged in secondary employment will conform to all laws, City policies, and Departmental policies when working a secondary employment assignment.

Officers engaged in secondary employment will take appropriate action to enforce the law and preserve public safety.

Officers engaged in secondary employment will not act to enforce the rules and regulations of an employer, which are not otherwise violations of the law.

1030.3 RESPONSIBILITIES OF OFFICERS ENGAGED IN SECONDARY EMPLOYMENT

Officers who wish to engage in secondary employment must recognize their primary responsibilities, obligations, and duties are to the Salt Lake City Police Department.

Officers are subject to call anytime for emergencies, special assignments, or overtime duty (in accordance with the applicable MOU), and no secondary employment will infringe upon this obligation.

Officers engaged in secondary employment will be subject to all rules, policies, directives, and standard operating procedures of the Salt Lake City Police Department.

If police action is necessary during a secondary employment job, Department rank supersedes secondary employment rank/assignment.

Officers will provide the PSC with a completed W9 form, when requested, in a timely manner.

Officers engaged in secondary employment will wear an approved Department uniform. Should a business require different attire (i.e., plain clothes) the reasons for the request must be specifically addressed to the PSC. The Secondary Employment Lieutenant will authorize or deny these requests.

Officers will be required to complete all necessary police reports as situations dictate while engaged in secondary employment. Moreover, officers who engage in secondary employment will be responsible for the initial investigation of all offenses that occur during their shifts at their secondary employment site. The exception to this requirement is when an investigation requires immediate follow-up off-site.

Officers will not sign up other members in POSE for job assignments.

Officers will sign up for only those jobs they intend to work.

Officers who sign up for a secondary employment shift will report for duty at the time and place specified, with all necessary equipment required.

Salt Lake City Police Department

SLCPD Policy Manual

SLCPD Policy Manual

Secondary and Outside Employment

Officers may release a shift they signed up for on POSE before the start of that shift, however, it is still the responsibility of the officer to work that shift if no one else acquires it.

Absences from a secondary employment shift may only be excused for significant personal or family illnesses, family emergencies, or prior arrangements with the secondary employer.

Changes in on-duty schedules, court, training, or other Departmental duty assignments will take precedent over any secondary employment. Officers should release a conflicting secondary employment job as soon as they are notified of the on-duty conflict.

Officers are required to work the scheduled hours assigned in POSE. Any officer unable to complete the designated hours of employment must contact the Watch Commander prior to leaving the employer's work site, and email the PSC and Secondary Employment Lieutenant to document the reason(s) why this was necessary.

1030.4 TIME LIMITATIONS OF OFFICERS ENGAGED IN SECONDARY EMPLOYMENT

Officers may work up to 16 hours daily of combined duty hours, secondary employment hours, City-contracted secondary employment hours (this does not include Department-directed or court overtime), and training time outside of the employee's duty hours. However, no officer will exceed a total of 72 accumulated hours per week in any combination of duty hours, secondary employment hours, City approved overtime (this does not include Department-directed or court overtime), and training time outside of the employee's duty hours. Furthermore:

- (a) During a 24-hour period, officers must have a minimum of 6 consecutive hours in which they are not working on-duty or engaged in secondary employment.
- (b) A week begins at 00:00 on Sunday and ends at 23:59 on Saturday.
- (c) Any exception to the hourly maximum requirements must be granted by the Secondary Employment Lieutenant.
- (d) Unforeseen circumstances may present themselves while an employee is working a secondary employment job that may necessitate an increase in time of the employee's secondary employment shift. In these instances, the affected officer will notify the Watch Commander and email the Secondary Employment Lieutenant and PSC documenting the reason for the increase.
- (e) With supervisor approval, vacation time, holiday time, and/or personal leave may be used to reduce duty work hours.
- (f) Officers, who due to personal illness or injury, do not report to or complete a scheduled duty shift, may not work any secondary employment within 24 hours of the start time of the missed or incomplete shift.

1030.5 SECONDARY EMPLOYMENT - RESTRICTIONS

Officers are strictly prohibited from participating in any secondary employment while they are on-duty.

Salt Lake City Police Department

SLCPD Policy Manual

SLCPD Policy Manual

Secondary and Outside Employment

Employees shall not adjust shifts to work secondary employment jobs unless the shift adjustment is for a specific Department need that is pre-approved by their supervisor. Otherwise, supervisors shall not approve shift adjustments for secondary employment jobs.

Officers whose duties include working undercover are prohibited from working any secondary employment or voluntary overtime in uniform. Officers whose duties include working undercover also cannot act as a POC.

Officers are prohibited from participating in secondary employment until after they have completed the Field Training Program.

Officers will not become involved in labor controversies of any kind connected with secondary employment.

Officers will not engage in secondary employment, whether in or out of uniform, when such employment is outside the city limits of Salt Lake City. Exceptions to this rule may only be granted by the Chief of Police or their designee.

Officers, while engaged in secondary employment, will not be accompanied by family members, friends, acquaintances, or visitors unless specific approval has been given by the secondary employer and the Secondary Employment Lieutenant.

Officers will not work secondary employment jobs if they are on any duty status other than full duty.

- (a) If an employee is utilizing parental leave, they may still engage in secondary employment work as long as it does not take place during the shift hours that the parental leave is compensating them for, with exception to City-paid overtime as referenced below in the Compensation for Secondary Employment section.

Officers are specifically prohibited from engaging in the following secondary employment:

- (a) Employment that presents a real, potential, or apparent conflict of interest between the officer's duties as a Department member and their duties for the secondary employer.
- (b) Employment that may bring the officer or the Department into disrespect, disfavor, disrepute, or ridicule by virtue of the secondary employment.
- (c) When the primary business of the establishment is the sale and consumption on-premises of alcoholic beverages, except with the authorization of the Chief of Police or their designee.
 - i. This restriction does not include employment inside establishments where alcoholic beverages are sold, but not consumed on premises (i.e., liquor stores).
- (d) Employment at establishments which sell merchandise of a sexual or pornographic nature as their primary source of revenue, or that otherwise provides entertainment or services of a sexual nature; employment at topless bars, X-rated video or bookstores, or adult entertainment establishments.
- (e) Employment as a process server, bail bondsman, property re-possessor, bill collector, towing vehicles, or any other employment in which police authority might tend to be used to collect money or merchandise for private or commercial purposes.

Salt Lake City Police Department

SLCPD Policy Manual

SLCPD Policy Manual

Secondary and Outside Employment

- (f) Any employment for private security companies or any business that provides private investigations or background checks.
- (g) Protection of management, employees, or property during a strike or labor dispute.
- (h) Working paid or unpaid as a Reserve Officer for another law enforcement agency.
- (i) Where an officer may be involved in photographs, voice recordings, or advertisements endorsing commercial products while being identified as a Salt Lake City Police Department police officer.
- (j) As a consultant for any person or entity who is either under investigation by any government agency as a suspect in a criminal matter, or who is a litigant, or proposed litigant, against Salt Lake City Corporation, or any of its Departments or employees, or any other government agency.

1030.6 REQUESTS FOR SECONDARY EMPLOYMENT

All secondary employment will be coordinated through the PSC. Department members will not engage in secondary employment arranged through an individual or business other than the PSC.

Any business or person that wishes to retain the services of Salt Lake City Police Department off-duty officers for secondary employment purposes needs to direct their request(s) through the PSC. The PSC will have prospective employers complete a Salt Lake City Police Department Secondary Employer Employment Agreement. This document outlines the employer's requirements, and the requirements of the Department.

If the prospective employer agrees to and completes the Salt Lake City Police Department Secondary Employer Employment Agreement, the PSC will forward the request to the Secondary Employment Lieutenant for final approval. If the Secondary Employment Lieutenant cannot be contacted, the PSC may contact the on-duty Watch Commander for approval.

This process will be followed for each new business or entity that contacts the Department for initial approval to engage in secondary employment.

Secondary employment will not be provided to any organization, association, movement, or group that has adopted a policy of advocating violence or acts of force to deny others their Constitutional rights.

Quarterly, the PSC will forward a list of all new business or entities that have entered into secondary employment agreements to the Chief of Staff for review.

1030.6.1 STAFFING LARGE AND/OR HAZARDOUS SECONDARY EMPLOYMENT JOBS

If a business or individual makes a request to the PSC for a secondary employment job where a threat of violence has been expressed, or is believed imminent by the employer (i.e., workplace violence), a minimum of two officers will be required to staff the job.

During the Secondary Employment Lieutenant's review of new requests for secondary employment officers, he or she may require the secondary employer to hire additional officers as they see fit for safety purposes. This determination may be based upon a variety of factors, to

Salt Lake City Police Department

SLCPD Policy Manual

SLCPD Policy Manual

Secondary and Outside Employment

include, but not limited to: the presence/absence of on-duty supervision, estimated attendance, the sale/or consumption of alcoholic beverages on the premises, previous history, site layout, traffic and/or parking issues, general crime trends in the vicinity, and analysis by the SLIC. If the secondary employer does not agree to the determined number, the request for secondary employment officers will be denied.

Moreover, if the determined number of positions cannot be filled 48 hours prior to the start of the job, the job will be canceled and no officers will be allowed to work the assignment. Notwithstanding, when the Department is contacted for a short-notice job that is deemed large and/or hazardous, attempts may be made to fill the determined number of officer positions, while recognizing that if the officer positions are not filled within a reasonable amount of time before the start of the job (to be determined by the Secondary Employment Lieutenant and/or the PSC) the job will be canceled.

Any secondary employment job calling for 5 to 10 officers working the same job at the same time will require 1 supervisor. For every additional 10 officers, at least 1 additional supervisor will be required. Supervisors working secondary employment jobs maintain their authority and responsibilities of rank, regardless to whether or not they are the POC officer.

- (a) The Secondary Employment Lieutenant may waive the supervisor requirement based upon a variety of factors, to include, but not limited to: the presence/absence of on-duty supervision, estimated attendance, the sale/or consumption of alcoholic beverages on the premises, previous history, site layout, traffic and/or parking issues, and general crime trends in the vicinity.

1030.6.2 MASS GATHERINGS - OVERWATCH

Occasionally, special event petitioners and secondary employers request specialized personnel to provide overwatch at a venue/job site where a mass gathering is associated with the event/job. This is in addition to what are, or would otherwise be, normally staffed positions.

In order to accommodate these requests and provide for the safety of citizens at these gatherings, the Secondary Employment Lieutenant has established a restricted list of qualified officers authorized to perform overwatch duties. The Secondary Employment Lieutenant has also appointed a supervisor to act as the POC for these assignments.

Any requests for overwatch assignments will initially be routed to the Secondary Employment Lieutenant for review, and then forwarded to the overwatch POC for staffing and posting through the PSC. Once the overwatch assignment is posted, the POC will assume all management aspects of that assignment.

Job requests for overwatch will only be utilized in addition to existing staffing (unless otherwise authorized by the Chief of Police or designee), and will be paid at an overtime rate, despite any existing fee-based rate utilized by the secondary employer. Payment should be processed through the secondary employer's payroll.

Requests for overwatch will be based on the ability of the officers on the restricted list to fulfill such requests and are not guaranteed. Such requests will be staffed by a minimum of 2 officers for a

Salt Lake City Police Department

SLCPD Policy Manual

SLCPD Policy Manual

Secondary and Outside Employment

minimum of 4 hours. If the officers on the restricted list cannot fill an overwatch request within 48 hours prior to the start of the job, the job will be canceled.

1030.7 NON-RESTRICTED SECONDARY EMPLOYMENT

If a secondary employer does not request a restricted secondary employment status, any eligible officer may work shifts for that employer.

1030.8 RESTRICTED SECONDARY EMPLOYMENT

A secondary employer may request designation as a restricted secondary employer, where only specific officers are authorized to work for them.

1030.8.1 SELECTION FOR RESTRICTED SECONDARY EMPLOYMENT JOBS

When a new restricted secondary employment job is established, the PSC will send a Department-wide email notifying Department members of the job, along with the proper procedure for notifying the PSC of interest. Selection for the job will follow one of the following procedures:

- (a) If the secondary employer wishes to conduct interviews and/or request resumes and then select which officers to employ, that is the procedure that will be followed.
 - i. The PSC is the person responsible for submitting resumes, and/or names for interviews, to the secondary employer.
- (b) If the secondary employer does not wish to review resumes and/or conduct interviews, the PSC and Secondary Employment Lieutenant will conduct a random drawing to determine the officers that will be assigned to the restricted job.

When openings at an already established secondary employer occur, selection of new officers will follow one of the following procedures:

- (a) If the secondary employer wishes to conduct interviews and/or request resumes and then select which officers to add to the restricted list, that is the procedure that will be followed.
 - i. The PSC is the person responsible for submitting resumes, and/or names for interviews, to the secondary employer.
- (b) If the secondary employer does not wish to review resumes and/or conduct interviews, the PSC and Secondary Employment Lieutenant will conduct a random drawing to determine the officers that will be added to the restricted list.

1030.8.2 POINT OF CONTACT (POC) FOR RESTRICTED SECONDARY EMPLOYMENT JOBS

Each restricted secondary employment job will have a POC. The POC is typically designated by the secondary employer. The POC facilitates communication between the employer and the PSC, but does not have the ability to hire and/or fire individual officers for the restricted job they are the POC over.

If the secondary employer does not designate the POC, officers who are selected to work the restricted job may notify the Secondary Employment Lieutenant that they are interested in the POC position. The Secondary Employment Lieutenant will determine the POC from those who express

Salt Lake City Police Department

SLCPD Policy Manual

SLCPD Policy Manual

Secondary and Outside Employment

interest. If no selected members notify the Secondary Employment Lieutenant of an interest in the POC position, the Secondary Employment Lieutenant will appoint a POC from the selected officers.

If a POC separates from a restricted secondary job, or otherwise relinquishes the position, the secondary employer may appoint a new POC. If the secondary employer declines this option, the Secondary Employment Lieutenant will follow the same procedures as above.

The duties of the POC are:

- (a) Keeping a current list of officers who are eligible to work the restricted job.
- (b) Informing the PSC of staffing level changes/needs (i.e., the need for additional staffing, and/or the separation of Department members from the restricted job).
- (c) Informing the PSC in a timely manner of changes in shift scheduling/shifts worked.
- (d) Informing the PSC of any missed shifts by officers working the restricted job.
- (e) If the restricted job does not utilize POSE for shift scheduling purposes, keeping an accurate schedule of shifts worked and by whom, and turning it in to the PSC by the 10th of the following month.
- (f) If the restricted job does utilize POSE for shift scheduling purposes, informing the PSC in a timely manner of shift-swaps not reflected on POSE.

Once every 6 months, the PSC will review the POC's compliance with the above duties with the Secondary Employment Lieutenant. If the POC is not meeting the required duties, their status as the POC will be placed on probation. If at the next 6 month review the POC is still not meeting the required duties, the Secondary Employment Lieutenant will follow the procedures above for selecting a new POC for that particular restricted job.

An officer shall only be the POC for a maximum of two secondary employment jobs.

1030.9 RESPONSIBILITIES OF POLICE SERVICES COORDINATOR (PSC)

The PSC serves as the liaison between the Department and secondary employers.

The PSC is responsible for the posting and maintenance of secondary employment jobs on POSE.

If a restricted secondary employment job does not conduct shift sign-ups on POSE, the PSC is responsible for recording and documenting the shifts worked for those jobs after receiving the schedules from the POC for the restricted job.

The PSC is responsible for managing the administrative aspects of secondary employment (e.g., overseeing Employer Agreement Forms, disseminating finalized shift sign-ups, invoicing secondary employers for the fuel/equipment surcharge for every secondary employment shift worked, distributing applicable tax forms, etc.).

Every year, the PSC will contact each business or entity to renew their Salt Lake City Police Department Secondary Employer Employment Agreement, to ensure that all businesses and entities are still in compliance with the requirements and restrictions incumbent upon them for their

Salt Lake City Police Department

SLCPD Policy Manual

SLCPD Policy Manual

Secondary and Outside Employment

engagement in secondary employment. If it is found that any secondary employer is not meeting all requirements, the PSC will notify the employer, advise them of necessary corrections, and ensure that all work by officers cease until the proper corrections have been made.

1030.10 AVAILABILITY OF SECONDARY EMPLOYMENT JOBS

The PSC will determine how many shifts officers can sign up for within a given time period once a secondary employment job becomes available. For example, officers may be able to sign up for one shift of a particular job in the first 24 hours, another shift in the second 24 hours, and then an unlimited number after that time period. Randomized sign-up times may also be implemented. The PSC will make the determination based on factors that include, but are not limited to:

- (a) The number of shifts available.
- (b) Consultation with the POC of a restricted secondary employment job.
- (c) The preferences of the employer.
- (d) The time between when the PSC is notified of the need for secondary employment officers and the time the secondary employment shifts begin.

1030.11 CITY-CONTRACTED SECONDARY EMPLOYMENT

Secondary employment jobs at City-owned facilities or involving City overtime will be treated in the same manner as any other secondary employment job, with the exceptions of:

- (a) Officers who are not eligible for overtime within the Department (i.e., Lieutenants and above), are not eligible for these jobs.
- (b) MOU stipulated minimum time payments (i.e., Special Events).
- (c) Compensation restrictions as listed below in the Compensation for Secondary Employment section.

1030.12 COMPENSATION FOR SECONDARY EMPLOYMENT

Secondary employers shall pay officers through their own payroll services or through City payroll services. The following rules apply to secondary employment jobs compensated through City payroll services:

- (a) Secondary employers which are contracted or budgeted through City payroll will pay Department overtime rates for actual costs incurred through City payroll.
- (b) Lieutenants and above (exempt employees) are restricted from working jobs that pay overtime through City payroll.
- (c) Employees may take leave time to work a secondary employment job that is not paid through City payroll.
- (d) Employees shall not take leave time to work a secondary employment job that is paid through City payroll.
- (e) Employees that have not worked 40 hours in a week, and have worked a secondary employment job paid through City payroll during that same week, shall submit for straight pay for the secondary employment job paid through City payroll.

Salt Lake City Police Department

SLCPD Policy Manual

SLCPD Policy Manual

Secondary and Outside Employment

1. Leave time other than holidays will not be counted as hours worked for overtime calculations.
 - (f) Employees shall not adjust shifts to work secondary employment jobs unless the shift adjustment is for a specific Department need that is pre-approved by their supervisor. Otherwise, supervisors shall not approve shift adjustments for secondary employment jobs.
 - (g) Regardless of the above, MOU stipulated minimum time payments (i.e., special events, callouts, etc.) will still be paid as outlined in the applicable MOU.

Effective January 1, 2023, the minimum pay for police officer secondary employment will be reviewed by the Secondary Employment Committee consisting of the Secondary Employment Lieutenant, the Secondary Employment Coordinator, one Sergeant, and two officers. The rate will be reviewed every 3 years (sooner or later if deemed necessary).

If secondary employers want to hire officers for less than 4 hours, they may do so, but they shall pay officers a minimum of 4 hours compensation.

1030.12.1 SECONDARY EMPLOYMENT AND PARENTAL LEAVE

Parental leave is time given by the City as a benefit to employees for a specific event in their lives. Due to this unique type of leave, the City restricts Department overtime during parental leave since the leave must be continuous. The City also restricts secondary employment during parental leave so that employees are not working secondary employment during the regular hours they would have been working if not for the parental leave. The following rules apply to secondary employment during parental leave:

- (a) Employees shall not work Department overtime or any additional work which would be paid through City payroll while on parental leave.
- (b) Employees may work secondary employment that is not paid through City payroll while on parental leave, but only outside of what would have been the employee's normal work schedule if not for the parental leave.
- (c) Employees receiving work-related subpoenas for appearance during parental leave will be compensated in accordance with the applicable MOU if the appearance time is outside what would have been the employee's normal work schedule if not for the parental leave. If this situation presents itself, an employee must contact the Police Financial Services Unit to coordinate payment/leave time.
- (d) If an employee receives a work-related subpoena for appearance during parental leave, and the appearance time is during what would have been the employee's normal work schedule if not for the parental leave, the employee must contact the Police Financial Services Unit to coordinate payment/leave time.

1030.13 CORRECTIVE ACTION

Department members are required to notify a supervisor whenever they learn, through personal observation or report, of any violation of the secondary employment policy. The supervisor will:

- (a) Conduct an initial inquiry into the circumstances.

Salt Lake City Police Department

SLCPD Policy Manual

SLCPD Policy Manual

Secondary and Outside Employment

- (b) If necessary, complete a BlueTeam entry.
 - i. Unexcused absences from a secondary employment shift require a BlueTeam entry.

Supervisors personally observing a violation will:

- (a) Take the appropriate action to address the issue.
- (b) Determine if the subject member needs to immediately discontinue the secondary employment job.
- (c) If necessary, complete a BlueTeam entry.
 - i. Unexcused absences from a secondary employment shift require a BlueTeam entry.

When a supervisor creates a BlueTeam entry for an unexcused absence from a secondary employment shift, the Internal Affairs Unit will categorize the entry as an M-file and route it to the Secondary Employment Lieutenant for disposition. As a matter of policy, unexcused absences from a secondary employment shift will result in suspension from the secondary employment program for a specified period of time. The typical schedule for suspension is as follows:

- (a) The first unexcused absence from a secondary employment shift within a 2-year period will result in a warning.
- (b) The second unexcused absence from a secondary employment shift within a 2-year period will result in a 30 day suspension from signing up for secondary employment shifts and working any secondary employment shifts that the officer is regularly scheduled for.
 - i. The suspension will take effect at the beginning of the month immediately following the time when the employee is informed of the suspension; the officer is still responsible for working the shifts they are scheduled for leading up to the beginning of the suspension.
- (c) The third unexcused absence from a secondary employment shift within a 2-year period will result in a 6 month suspension from signing up for secondary employment shifts and working any secondary employment shifts that the officer is regularly scheduled for.
 - i. The suspension will take effect at the beginning of the month immediately following the time when the employee is informed of the suspension; the officer is still responsible for working the shifts they are scheduled for leading up to the beginning of the suspension.
- (d) A fourth unexcused absence from a secondary employment shift within a 2-year period will result in an indefinite suspension from signing up for secondary employment shifts and working any secondary employment shifts that the officer is regularly scheduled for. The affected officer may apply, in writing, for reinstatement to the program after a 1-year period from the date the suspension began. This application will be made to the Secondary Employment Lieutenant, but the final reinstatement decision will be determined by the Chief of Police.

Salt Lake City Police Department

SLCPD Policy Manual

SLCPD Policy Manual

Secondary and Outside Employment

- i. The suspension will take effect at the beginning of the month immediately following the time when the employee is informed of the suspension; the officer is still responsible for working the shifts they are scheduled for leading up to the beginning of the suspension.

The schedule of suspensions outlined above may be modified based on the circumstances behind the policy violation(s).

1030.14 OUTSIDE EMPLOYMENT

As per Salt Lake City Codes 2.44.050 and 2.44.060, any member of the Department who is an officer, director, agent, employer, or employee of any business entity, or the owner of a substantial interest in any business entity, including any business entity subject to City regulation, must disclose this fact to the City. This disclosure is accomplished by completing a Salt Lake City Corporation Disclosure Statement of Non-City Employment/Business Interests form and forwarding it to the PSC. [See attachment: Salt Lake City Corporation Disclosure Statement of Non-City Employment Business Interests.pdf](#)

Department members are strictly prohibited from participating in any outside employment while they are on-duty. Members are specifically prohibited from engaging in the following outside employment:

- (a) Employment that presents a real, potential, or apparent conflict of interest between the employee's duties as a Department member and their duties for the outside employer.
- (b) Employment that may bring the employee or the Department into disrespect, disfavor, disrepute, or ridicule by virtue of the outside employment.
- (c) When the primary business of the establishment is the sale and consumption on-premises of alcoholic beverages, except with the authorization of the Chief of Police or their designee.
 - i. This restriction does not include employment inside establishments where alcoholic beverages are sold, but not consumed on premises (i.e., liquor stores).
- (d) Employment at establishments which sell merchandise of a sexual or pornographic nature as their primary source of revenue, or that otherwise provides entertainment or services of a sexual nature; employment at topless bars, X-rated video or bookstores, or adult entertainment establishments.
- (e) Employment as a process server, bail bondsman, property re-possessor, bill collector, towing vehicles, or any other employment in which police authority might tend to be used to collect money or merchandise for private or commercial purposes.
- (f) Employment that requires a member to provide private investigations or background checks as their primary duty.
- (g) Protection of management, employees, or property during a strike or labor dispute
- (h) Employment or voluntary capacity as an expert witness for a litigant, in a civil case or for a criminal defense attorney, or defendant in a criminal case in any jurisdiction, without approval from the Chief of Police.

Salt Lake City Police Department

SLCPD Policy Manual

SLCPD Policy Manual

Secondary and Outside Employment

- (i) Employment as a consultant for any person who is a litigant, or proposed litigant, against Salt Lake City Corporation, or any of its Departments or employees.

Members employed in a security capacity should defer law enforcement duties to the appropriate jurisdictional authority. An employee entering into a contract for security employment, will complete the required disclosure form and receive approval through the Chief of Police, or designee, per Utah Code 53-13-114.

The use of Department identification/forms which include, but are not limited to, Departmental letterhead, records, insignia, badges, and logos will not be used to seek outside employment unless approved by the Chief of Police.

- (a) This does not prevent a Department member from stating they are a Salt Lake City Police Department employee and providing their experience/training when providing their information to a prospective outside employer.
- (b) Outside employers are permitted to provide Salt Lake City Police Department members' biographical information on official correspondence as it relates to policing-related course instruction.

1030.15 REVISIONS

Enacted: May 14, 2018

Revised: August 20, 2018

Revised: September 10, 2019

Revised: July 5, 2022

Performance Improvement Plans

1031.1 PURPOSE AND SCOPE

A Performance Improvement Plan (PIP) is intended to be a positive approach designed to assist employees who have demonstrated substandard performance or behavior and who may benefit from intervention before it results in discipline or other negative consequences. A PIP is not intended to be discipline. Rather, it is intended to aid employees by implementing a structured, written intervention plan focused on achieving desirable performance or behavior outcomes. In addition, the PIP serves as an integral tool of the performance appraisal process in that it provides timely, constructive feedback while creating opportunities for an employee to receive supervisory guidance and assistance to correct deficient work. This proactive strategy reflects the Salt Lake City Police Department's commitment to maintaining employee performance and behavior to the standards reflected in the Department's performance evaluation dimensions and policies.

While a PIP by itself is not considered discipline and is kept separate from Internal Affairs files (described in more detail below), a PIP may be used in conjunction with, or as a result of, a disciplinary proceeding, at which time it will become part of the relevant Internal Affairs case file.

1031.2 PROCESS

The components of a Performance Improvement Plan include Identification and Selection, Plan Development, and Plan Administration.

1031.2.1 IDENTIFICATION AND SELECTION

The purpose of identification and selection is to first recognize a pattern of performance and/or behavior which fails to meet performance expectations or policy standards. Supervisors are charged with continuously evaluating the work of department members under their purview, and to identify those employees who may benefit from a performance or behavior intervention. Furthermore, supervisors are expected to analyze the substance of substandard performance and/or behavior to determine the most appropriate course of corrective action. The PIP is not intended to replace disciplinary intervention when supervisors determine discipline to be the most appropriate course of action.

In most cases when there is a minor policy violation or performance deficiency, supervisors may institute progressive intervention. Progressive intervention may include, but is not limited to, verbal counseling and training. If training is determined to be an intervention before a Performance Improvement Plan is instituted department members shall complete the training to determine if this rectify's the problem. All training completed by the department member shall be documented in the department's web-based training system.

A supervisor may consider selection for a Performance Improvement Plan once progressive intervention efforts fail to produce desired results. Should a supervisor choose to select an employee to participate in a PIP, s/he shall first seek the approval of the affected employee's Division Commander. Upon approval of the Division Commander, the supervisor shall notify the affected employee of their intention to implement a PIP as soon as practical.

Salt Lake City Police Department

SLCPD Policy Manual

SLCPD Policy Manual

Performance Improvement Plans

1031.2.2 PLAN DEVELOPMENT

The affected employee's supervisor will be responsible to author the content of the PIP unless otherwise directed by the responsible Division Commander. The PIP document will consist of seven distinct categories found in the online Workday form and are as follows:

- (a) **Problem Description** - Provide a specific observation of the unsatisfactory performance.
- (b) **Job Function** - Identify the area(s) of improvement.
- (c) **Action Plan** - What action must be taken to achieve success in meeting expectations?
- (d) **Summary** - Any additional information which needs to be brought to the employee's attention for improvement.
- (e) **Goals** - Identify obtainable goals for the employee to achieve in order to improve performance.
- (f) **Strategies to Achieve Desirable Performance and/or Behavior Outcomes** - This section of the PIP is intended for the supervisor and the affected employee to work together in crafting objectives intended to map a successful outcome. Objectives should follow the SMART goals framework:
 - 1. Specific - Write expectations that are clear and concise to help ensure the employee grasps an understanding of them.
 - 2. Measurable - Install benchmarks so that progress or lack thereof is readily discernible.
 - 3. Attainable - Make reasonable efforts to ensure the employee has ample opportunity and resources to meet the expectations of the objective.
 - 4. Relevant - Draw a clear nexus between the expectation and named performance dimensions or policy standards.
 - 5. Time-Based - Develop a reasonable timeline to help define expectations and motivate positive progress.
- (g) **Performance Improvement Plan Terms** - This section of the PIP defines the duration of the plan, prescribes supervisor feedback intervals, and other necessary terms. The following guidelines should apply to the PIP terms:
 - 1. Duration - The duration of a PIP should be no longer than three months unless the affected employee's Division Commander determines an extension (not to exceed an additional three months) is likely to benefit both the affected employee and the Department. The PIP may be tolled to compensate for employee leave of absence and resume upon their return to full duty.
 - 2. Feedback Intervals - The PIP administrator is expected to provide timely feedback and ongoing guidance to the affected employee. The administrator should make reasonable efforts to meet with the employee no less than bi-weekly unless circumstances require a change of administrator or other unanticipated needs.

Salt Lake City Police Department

SLCPD Policy Manual

SLCPD Policy Manual

Performance Improvement Plans

3. Other Necessary Terms - Other necessary terms may include, but are not limited to the following:
 - (a) The employee may be required to attend remedial training prescribed by the PIP administrator.
 - (b) The employee may submit to a voluntary assignment transfer.
 - (c) The PIP administrator may limit or restrict the affected employee from participating in work activities outside the scope of their primary assignment including but not limited to ancillary responsibilities, voluntary overtime assignments, or other work that the PIP administrator reasonably believes may impede the employee's progress or success.
 - (d) Employees who are participating in a PIP will not be placed into a special assignment.

1031.2.3 PLAN ADMINISTRATION

The Performance Improvement Plan will be administered in the following manner:

- (a) Supervisor Responsibilities:
 1. Supervisors who identify a need for an employee to participate in a PIP shall first obtain approval to proceed from the identified employee's Division Commander.
 2. If approved, the supervisor enters the information into Workday, under the Performance Improvement Plan area, and submits the plan. The plan is then routed to the Human Resources Business Partner (HRBP) for review.
 3. After receiving approval from the HRBP, the supervisor must meet with the PIP recipient to discuss the PIP.
 4. If the PIP recipient is moved to a different supervisor before a performance evaluation is scheduled, it is the responsibility of the supervisor who administered the PIP to inform the new supervisor of the PIP.
 - (a) The PIP recipient's supervisor summarizes the PIP in the employee's performance evaluation during the same rating period as the PIP.
- (b) PIP Administrator Responsibilities:
 1. The supervisor charged with administering the PIP will be known as the PIP administrator. The PIP administrator is typically the receiving employee's direct supervisor but may be a different supervisor due to the needs of the employee or the Department, unanticipated absence, or change of assignment.
 2. The PIP administrator should present the final version of the PIP to the recipient. Then discuss and explain its content, expectations, and terms.
 3. The PIP administrator is expected to execute the terms of the PIP.
 4. The PIP administrator will document counseling sessions, feedback, employee progress or lack thereof, final review, or any other relevant information into Workday.

Salt Lake City Police Department

SLCPD Policy Manual

SLCPD Policy Manual

Performance Improvement Plans

(c) Division Commander Responsibilities:

1. Review the draft PIP, make changes or recommendations as necessary, and provide final approval to execute the PIP.
2. Review written rebuttals properly delivered in the manner described below and direct changes or recommendations to the PIP as deemed necessary.
3. Ensure feedback, final review, written rebuttals, or other relevant documents are attached to the PIP.

(d) Employee Responsibilities:

1. PIP receiving employees will meet with his/her supervisor as directed and provide input into the development of the PIP in a reasonable and constructive manner.
2. The employee will review and acknowledge that s/he has read the final version of the PIP by logging into Workday and acknowledging electronically.
3. The employee retains the opportunity to prepare a written rebuttal to the PIP and forward it through his/her chain of command to the responsible Division Commander. The written rebuttal must be presented within 5 calendar days after the start date of the PIP.
4. The employee will honor the terms of the PIP and update the "Goals" section in Workday so the supervisor may see the progress in real-time.
5. The employee may be assigned goals to meet the requirements of the PIP. These goals will be in Workday for the employee to review and provide updated information on the status of their goal(s).

1031.3 RECORDS

Once the PIP is initiated, it and any attachments will be retained in the Performance Improvement Plan file of the Division of the affected employee. Performance Improvement Plan files will be secure, and all PIPs shall be classified and handled as private records (Utah Code 63G-2-302).

Employees may view a PIP through their Workday profile account.

1031.3.1 PIPS PURSUANT TO A DISCIPLINARY PROCEEDING

A PIP that is used in conjunction with, or as a result of, a disciplinary proceeding will still be kept in the applicable Division's Performance Improvement Plan file. However, a copy of the PIP, and any attachments, will also be included in the related Internal Affairs case file.

1031.4 REVISIONS

Enacted: May 21, 2018

Revised: July 5, 2022

Revised: April 4, 2023

Peer Support Program

1032.1 PURPOSE AND SCOPE

This policy outlines the role of the department's Peer Support Program and sets the expectations associated with participation in the Peer Support Program.

The Peer Support Program provides department members with emotional and other forms of support in times of crisis. The Peer Support Program exists to create a connection between department members in crisis and their fellow colleagues who may have similar experiences. The purpose of the program is to offer peer-to-peer support during trying times and to help reduce/eliminate the stigma associated with seeking out professional mental health services by helping to connect department members to available resources and benefits.

The Peer Support Program is an elective and voluntary program operated by the department that offers assistance to department members as provided herein.

Peer Support Program Personnel may include:

- One, or more, full-time Peer Support Program facilitator(s), designated by the Employee Wellness and Support Program Coordinator;
- A team of collateral department employees/volunteers who have met the approved POST-recognized certification standard, designated by the Employee Wellness and Support Program Coordinator;

Peer Support Program Personnel may be comprised of sworn and/or non-sworn police department employees who have been specifically trained to assist in dealing with mental health symptoms, stress, and crises. Peer Support Program Personnel should not perform the duties of or otherwise act as counselors or therapists regardless of personal certifications or other duties within the department.

Peer Support Program Personnel work closely with and are overseen by the Employee Wellness and Support Program Coordinator. Various Peer Support Teams composed of a group of collateral department employees/volunteers may be established. The role of these Peer Support Teams is to assist department members by providing referrals to assistance and peer-to-peer support for physical, emotional, psychological, and overall well-being. Peer Support Program Personnel facilitate access to professional programs, but their role does not replace nor serve as a substitute for these programs. Peer Support Program Personnel may also provide assistance to any other entity as directed by the Chief of Police or designee.

1032.1.1 ORGANIZATION CHART

1032.2 DEFINITIONS

Communication – An oral statement, written statement, note, record, report, text, email, or document made during, or arising out of a meeting with Peer Support Program Personnel.

Salt Lake City Police Department

SLCPD Policy Manual

SLCPD Policy Manual

Peer Support Program

Contact Log- The live document that the peer support chain of command uses to communicate peer support contacts. There will be no personal identifying information of peers seeking assistance in the contact log. The contact log will include the date the contact is initiated, the name of the Peer Support Team leader, responding peer support member(s), responsible peer support sergeant, and disposition of the contact to include mandatory reporting criteria met (or pertinent negatives with respect to mandatory reporting).

Crime- Conduct constituting a city, state, or federal offense, but not including a traffic offense that is a class C misdemeanor or infraction.

Good Standing- Good Standing means that the department member meets the requirements for a transfer as provided by [Salt Lake City Police Department Policy Manual: 1002.3.2 DISQUALIFICATIONS](#).

Mental Health Crisis - any incident which causes severe physical or mental injury, usually due to an external agent. These events may include, but are not limited to:

- members involved in the use of deadly force;
- assault on a member involving a deadly weapon;
- injury, illness, or death of a member or family member;
- assisting the family with a member's death;
- catastrophic incidents such as an airplane crash, flood, or fatal accident;
- investigations involving death or severe injury to juveniles or any type of death;
- substance abuse;
- marital, relationship, health, family, financial, employment, or other personal problems.

Monthly Peer Support Member Contact Summary – The form Completed by peer support team members listing the number of contacts made, time spent, and topics addressed, composed on a monthly basis.

Non-confidential Information- Any communication made by a department member that falls within one or more of the confidentiality exceptions provided by subsection 2.3 (a) through (f).

Peer Support Program Personnel- Sworn and/or non-sworn department employees who have been specifically trained, in accordance with Utah Code Section 78B-5-903, to assist in dealing with mental health symptoms, stress, and crisis. Peer Support Program Personnel includes the Employee Wellness and Support Program Coordinator, the Peer Support Facilitator, and collaterals.

1032.3 PEER SUPPORT TEAM MEMBERS CONFIDENTIALITY

The Peer Support Program is designed to provide emotional support before, during, and after times of crisis to employees who express a need for assistance. The program shall, to the greatest extent allowable and advisable, promote trust, allow anonymity, and preserve confidentiality as

Salt Lake City Police Department

SLCPD Policy Manual

SLCPD Policy Manual

Peer Support Program

further provided herein. Department employees will not be forced to participate in the peer support Program as a form of corrective action or discipline.

Peer Support Personnel may refuse to disclose communications made by a person participating in Peer Support Program services, subject to the following exceptions:

- (a) The Peer Support Program Personnel was a witness or a party to the incident that prompted the delivery of Peer Support Program services;
- (b) The information received by the Peer Support Program Personnel is indicative of actual or suspected child abuse, or actual or suspected child neglect;
- (c) The department member receiving the services of the Peer Support Program is a clear and immediate danger to their self or others;
 - *Examples could include, but are not limited to:*
 - Suicidal ideation with a plan and the ability to carry out the plan if no intervention occurs*
 - Excessive alcohol consumption which necessitates emergency medical or law enforcement intervention
- (d) The communication establishes reasonable cause for the Peer Support Program Personnel to believe that the department member receiving peer support services is mentally or emotionally unfit for duty; or
 - *Examples could include, but are not limited to:*
 - Any circumstance where an employee is unable to perform essential job functions safely due to mental or emotional distress or crisis.
 - Uncontrolled emotions that have a reasonable likelihood of negatively impacting the performance of essential job functions based upon a reasonable officer standard-(If unsure see section 2.4 paragraph 2 of this policy for further guidance)
 - Impaired judgment which has a reasonable likelihood of negatively impacting the performance of job functions based upon a reasonable officer standard-(If unsure see section 2.4 paragraph 2 of this policy for further guidance)
 - Exhibiting signs of mental illness which would lead a reasonable officer to believe emergency medical care is needed-(If unsure see section 2.4 paragraph 2 of this policy for further guidance)
- (e) The communication provides evidence that the department member receiving the services of the Peer Support Program has committed a crime, plans to commit a crime, or intends to conceal a crime.
 - *Examples could include, but are not limited to:*
 - Official Misconduct as outlined in [Utah Code 76-8-201](#) and any successor provisions
 - Public Lewdness

Salt Lake City Police Department

SLCPD Policy Manual

SLCPD Policy Manual

Peer Support Program

Use of illegal drugs

Public Intoxication

Assault/Battery

Illegal or inappropriate use of information systems

Unlawful use of authority

Providing false or misleading information in official matters

1032.3.1 MANDATORY REPORTING PROCEDURE

Any act and/or communication made by a department member that implicates one or more of the confidentiality exceptions provided by subsection (a) through (e) above shall be reported immediately to a Peer Support Team Sergeant following the conclusion of the interaction with Peer Support Personnel. Upon receipt of the aforementioned notification, the Peer Support Team Sergeant shall report the matter up the chain of command utilizing the organizational chart within this policy. Failure to comply with the outlined reporting requirements may result in discipline and/or removal from the program.

Whenever there are questions or uncertainties about this policy's application, Peer Support Program Personnel shall seek direction from a Peer Support Sergeant.

1032.4 ETHICAL ISSUES

1032.4.1 PRIVACY AND CONFIDENTIALITY

Integral to the effectiveness of the Peer Support Program is the personal integrity of each department member and their respect for each peer's dignity, personal welfare, and personally protected information. Peer Support Program Personnel will likely have access to private and sensitive information about the peers' personal life. All communications are to be safeguarded and should not be disclosed unless said communications are considered Non-confidential Information under this policy, disclosure is immediately necessary to preserve life, in compliance with the law; and/or the department member utilizing the Peer Support Team Program services has otherwise provided written consent to release such information.

1032.4.2 INFORMED CONSENT

Department members utilizing the services of the Peer Support Team Program are presumed to be on notice regarding the confidentiality expectations, including the exceptions and mandatory reporting requirements, provided herein. By participating in the services of the Peer Support Team Program, individuals hereby authorize the release of Non-confidential Information.

1032.5 TRAINING

Initial training for any new Peer Support Program Personnel consists of a curriculum that is approved by the Peace Officer Standards and Training Division in accordance with applicable law. Additional training may be required by the Employee Wellness and Support Program Coordinator and/or the Chief of Police. The POST-approved curriculum contains but is not limited to instruction

Salt Lake City Police Department

SLCPD Policy Manual

SLCPD Policy Manual

Peer Support Program

concerning mental health, suicide, grief, chemical dependency (and other compulsive behavior), critical incidents, trauma, vicarious trauma, and referral techniques. 16 hours of continuing education is required for all Peer Support Program Personnel annually, 4 hours will be provided quarterly at the direction of the program facilitators. Peer Support Program Personnel are expected to remain current with the training requirements and failure to do so may result in removal from their role in the Peer Support Program.

1032.6 TEAM MEMBER SELECTION, DESELECTION, AND LEAVE

Peer Support Program Personnel must be in Good Standing with the Department. Peer Support Personnel including the Peer Support Program Facilitator will be selected by the Employee Wellness Program Coordinator, following policy 1002.3.3.

Peer Support Personnel including the Peer Support Program Facilitator serve in that capacity at the pleasure of the Employee Wellness Program Coordinator and may be removed from that assignment following the guidelines found in [Salt Lake City Police Department Policy Manual: 1002.4 REASSIGNMENTS](#). However, breaches of confidentiality, failure to attend training, loss of Good Standing within the Department, or failure to comply with the mandatory reporting requirements provided herein, may result in the removal of the Peer Support Program Personnel, including the Facilitator, from their duties.

Peer Support Program Personnel may request a sabbatical from the program, at any time by giving written notification to the Employee Wellness and Support Coordinator. A requested sabbatical should include the expected length of time until return to the program. A request for a sabbatical is subject to approval from the Employee Wellness Program Coordinator.

1032.7 PEER SUPPORT DURING INVESTIGATIONS

It is understood that employee involvement in any investigation is a stressful occurrence. It is the role of the Peer Support Program Personnel to assist employees in minimizing that stress, maintaining healthy habits, and facilitating applicable City benefits without interfering with the investigative process. If Peer Support Program Personnel respond in the context of an active investigation they may provide emotional support, referrals to services, and guidance through the process, but are not to discuss details of the active investigation.

No law enforcement action shall be taken against another employee of this department by Peer Support Team Personnel unless emergency circumstances necessitate immediate action to prevent danger to the employee or others. If Peer Support Program Personnel believes law enforcement action against a department member may be necessary, but the department member does not pose an immediate threat to themselves or others, Peer Support Personnel shall notify their chain of command who shall deconflict the matter to another law enforcement agency if practicable.

If a Peer Support Program Personnel takes law enforcement action against a department member notification of such action will be made as soon as reasonably possible to a Peer Support Sergeant. Ideally, this communication will occur prior to any action being taken. However, nothing in this

Salt Lake City Police Department

SLCPD Policy Manual

SLCPD Policy Manual

Peer Support Program

policy should be interpreted to preclude sworn Peer Support Program Personnel from taking necessary action to stabilize the scene and protect life.

1032.7.1 SUPERVISOR RESPONSIBILITIES

Upon receipt of information that law enforcement action is or was necessary against a department member, the Peer Support Sergeant shall notify the Employee Wellness and Support Program Coordinator who will then notify necessary chain of command.

1032.7.2 PRIOR APPROVAL FOR PEER SUPPORT ROLE OUTSIDE REGULARLY SCHEDULED HOURS

Peer Support Program Personnel who are requested to provide Peer Support Program services outside their regularly scheduled hours, must receive prior approval from the Employee Wellness and Support Coordinator or Watch Commander, when practicable, to perform work in excess of 15 minutes in duration. The member shall indicate on the overtime section notes which Team Lead was contacted for approval.

1032.8 FACILITATOR AND COORDINATOR RESPONSIBILITIES

1032.8.1 EMPLOYEE WELLNESS AND SUPPORT PROGRAM COORDINATOR RESPONSIBILITIES

The Employee Wellness and Support Program Coordinator will coordinate selection, activation, leave of absence, and deselection of Peer Support Team members. S/he will actively endeavor to resolve departmental issues and conflicts related to the Peer Support Program. S/he will ensure Peer Support Program Personnel complies with this policy. Communication with the Peer Support Sergeants and Facilitators will occur at the monthly Chiefs update and supervisor meeting. S/he will conduct or designate a facilitator to conduct Peer Support Program Personnel wellness checks.

1032.8.2 PEER SUPPORT PROGRAM FACILITATOR RESPONSIBILITIES

The Wellness Program Facilitator may be either a sworn or non-sworn position. The person is a full-time employee who facilitates Peer Support team response through the Peer Support Sergeants when any request by a department member is requested, including but not limited to initial contacts and Critical Incident Stress Debriefs. S/he will also help identify the needs of the various Peer Support Teams through regular coordination with the Peer Support Sergeants and Team Leads. S/he will be responsible for facilitating quarterly training for the Peer Support Program Personnel, which training shall be approved by the Wellness Program Coordinator. S/he will maintain the Peer Support Team roster(s), Team reported statistics obtained through the Peer Support Member Contact Log and Monthly Peer Support Member Contact Summary and provide any other monthly updates in the monthly Chiefs update and supervisor meeting.

S/he will maintain a current list of resources and providers offered by the Wellness Program that are available for Peers. They will stay up to date on current Peer Support practices and bring any recommendations to the Peer Support Sergeants for consideration. Facilitators will work with Peer Support Sergeants to ensure adherence to this policy. The Peer Support Program Facilitator

Salt Lake City Police Department

SLCPD Policy Manual

SLCPD Policy Manual

Peer Support Program

will also compile member contact summaries for entries. These will be used by Peer Support and Wellness Facilitators to track contacts and hours logged by team members. Facilitators will compile bi-weekly summaries of contact types and service trends and will submit team member hours to Peer Support Sergeants for overtime approval. They will report to the Employee Wellness and Support Program Coordinator.

1032.9 REVISIONS

Enacted: October 25, 2023

Military Leave and Reintegration

1033.1 PURPOSE AND SCOPE

This policy outlines the department's process for officers leaving for or returning from military service.

1033.2 MILITARY LEAVE OF ABSENCE

The Department supports the missions of the United States uniformed services. Employees who are members of the uniformed services shall be granted leaves of absence and receive any benefits or considerations required by Federal and State law, City policy and ordinance, and applicable MOUs.

Department employees who anticipate service with the uniformed services should notify their supervisor as soon as possible and provide any relevant order or documentation of such service. Early notification of such service will assist the Department to inform and assist the employee regarding the employee's City benefits or considerations. When an employee notifies their supervisor of any type of military leave, the supervisor is responsible for notifying the Command Staff, and Finance Unit, and ensuring the employee requests an absence through Workday. Salt Lake City Police Department Procedure Manual: 1010.2 LEAVE NOTIFICATION PROCEDURE

Any employee who anticipates service with the uniformed services shall coordinate with the Department Personnel Payroll Administrator (PPA) as soon as possible, prior to departure, and should enter their HR military required information in Workday in the "request absence" section.

1033.3 WHEN AN EMPLOYEE IS ACTIVATED TO MILITARY DUTY FOR A PERIOD EXCEEDING 180 DAYS

Once notified of the activation, the employee's Division Commander, or designee, will make contact with the employee to offer assistance. Once notified of an employee's activation to military duty, the Division Commander or designee should coordinate an appointment with the Office of the Chief to facilitate out-processing, including an exit interview with the Chief of Police or designee.

The employee should contact their supervisor as soon as possible. The employee will also contact the Quartermaster and the Department Fleet Coordinator to facilitate equipment storage. The supervisor is responsible for notifying the division Command Staff, and Finance Unit, and ensuring the employee requests an absence through Workday in the "request absence" section.

The employee, or the employee's spouse, may choose a contact person from the Department to be a point person for activities occurring between the employee's family and the Department. This contact person will maintain contact with the employee (if possible) and the employee's family, coordinating support efforts that are appropriate for the employee and his/her family.

The Division Commander or designee should ensure that a Military Extended Leave Form is completed and forwarded to the deployed member's personnel file. [See attachment: MilitaryExtended Leave Form.pdf](#)

Salt Lake City Police Department

SLCPD Policy Manual

SLCPD Policy Manual

Military Leave and Reintegration

1033.4 RETURNING FROM MILITARY DUTY FOR PERIODS EXCEEDING 180 DAYS

The employee will contact the Division Commander of the Division they were assigned to upon activation as soon as possible to notify them of the anticipated date of return to work. Documentation, including the employee's military release date, must be provided to the Division Commander. The Division Commander will notify the Department's Human Resources Consultant before the employee returns to work. Employees should then enter the return information in Workday under "Request return from leave of absence."

Once notified of an employee's return from military duty, the Division Commander or designee should coordinate an appointment with the Office of the Chief and Training Unit to facilitate in-processing, including an interview with the Chief of Police or designee. This will allow for required paperwork and training hours/recertification information to be gathered, as well as weapons requalifications.

The Division Commander or designee will assist the returning employee with the transition back to the Department. The assistance includes obtaining equipment, meeting with supervisors, updating training requirements, and assisting in answering questions the employee may have.

The Division Commander or designee should ensure that the Military Extended Leave Reintegration Form is completed and forwarded to the returning member's personnel file. See attachment: [Military Extended Leave Reintegration Form.pdf](#)

1033.5 REVISIONS

Enacted: September 2023

Chapter 11 - Airport Operations

Officer Response to Screening Refusals

1100.1 PURPOSE AND SCOPE

This policy provides guidance for Airport-assigned police officers when dispatched to assist the Transportation Security Administration (TSA) with incidents at passenger screening checkpoints.

1100.2 POLICY

Officers will act in support of TSA personnel as follows:

- (a) If an individual has entered the screening checkpoint area and has begun the required screening process, but then chooses to withdraw from screening, the responding officer will advise the individual that in accordance with TSA regulations they cannot leave and are required to complete the screening process prior to entering the sterile area or leaving the screening location.
- (b) If after being advised of the requirement to complete the screening process the individual agrees, the officer will standby near the screening location while the individual completes the screening process and inform Dispatch upon completion of the assignment.
- (c) If after being advised of the requirement to complete the screening process the individual continues to decline, the officer shall direct Dispatch to notify federal law enforcement and request the response of the on-duty Airport Bureau Patrol Sergeant. Detention for the purpose of completing security screening is reasonable as long as it is not prolonged beyond the time reasonably required to rule out the presence of weapons or explosives.
 - i. If an individual is detained, pending a federal law enforcement response, officers shall obtain the individual's identification, check the person for warrants, and complete a police report. Any/all further action will be dependent on the circumstances of each specific incident.
 - ii. The officer will accompany TSA as they escort the detained individual to the private screening area.
 - iii. The officer will advise Dispatch the individual has been detained, and request the FBI, TSA Assistant Federal Security Director for Law Enforcement (AFSD/LE), and Federal Air Marshals (FAM) be notified.
 - iv. The federal law enforcement agencies contacted will be asked if they are responding and if they want the person detained pending their arrival. Officers will detain individuals at the specific request of the responding federal law enforcement agencies.
 - v. If federal law enforcement agencies choose not to respond, or the US Attorney declines charges, the officer will obtain information required for a report, check the individual for warrants, and escort the person from the area. If the officer has observed a violation of local ordinance or state statute, and a federal declination has been received, the Airport Bureau Patrol Sergeant may authorize the officer to charge the individual.

Salt Lake City Police Department

SLCPD Policy Manual

SLCPD Policy Manual

Officer Response to Screening Refusals

- (d) At no time will an officer become involved in the screening process. If contraband or other evidence is found during the screening process, which establishes reasonable suspicion or probable cause the individual has violated the law, the matter will then be the responsibility of the officer.
- (e) If, based upon the officer's observations and/or experience, reasonable suspicion or probable cause exists to believe the person may be carrying a weapon or explosive, the officer may conduct a pat down search for officer safety. This is separate from, and not to be in conjunction with, or in lieu of, any search or screening conducted by TSA personnel.

If an officer is unsure of the proper course of action, they shall consult with their supervisor.

1100.2.1 SCREENING PROCESS LOCATIONS

The "screening process" may "begin," thus requiring completion of that process, at various locations. Depending on how the screening progresses in a particular case, additional screening steps may be required. The ranking TSA official at the screening location will advise the officer when the screening process has been completed.

1100.2.2 EXPLOSIVE TRACE DETECTION

Explosive Trace Detection (ETD) checks on individuals' hands and carry-on baggage for explosive residue may be conducted in the passenger queue line prior to the checkpoint, at security checkpoints, at boarding gates and at entrances to the Security Identification Display Area (SIDA). When conducting such testing, the TSA will place signs prior to the screening location notifying individuals that they are subject to screening. Additionally, signs have been placed after the screening checkpoint, indicating passengers may be subject to additional security checks prior to boarding their flights. Once an individual has been approached by the ETD team and instructed to present their hands or belongings for the swab process, they may no longer walk away and their attempt to do so or their refusal to submit will result in a police response. Responding officers should treat each case as a refusal and ensure the person does not leave until the completion of the screening process.

Officers will not be involved in resolving an ETD alarm.

1100.3 REVISIONS

Enacted: November 30, 2018

Firearms/Dangerous Weapons in Secure and Unsecured Areas

1101.1 PURPOSE AND SCOPE

This policy provides guidance for airport-assigned police officers when investigating possession of a firearm or dangerous weapon(s) in secured or unsecured areas of the Airport. Officers are responsible for providing law enforcement support to the TSA as they fulfill their passenger screening security requirements at the Salt Lake City International Airport. To this end, the desired result is to keep unauthorized firearms and other dangerous weapons out of the sterile/secure areas of the Airport and out of the passenger compartments of commercial aircraft.

1101.2 STATE STATUE

It is a violation of Utah Code 76-10-529 for any person, including a person licensed to carry a concealed firearm, to possess dangerous weapons, firearms, or explosives in a secure area of the airport (exceptions noted in Utah Code 76-10-529(2)(b)).

1101.3 POLICY

Officers shall follow proper procedure when investigating individuals in possession of firearms or dangerous weapons at the Salt Lake City International Airport.

[Salt Lake City Police Department Procedure Manual: 1101.2 PROCEDURE](#)

[Salt Lake City Police Department Procedure Manual: 1101.2.1 FIREARMS](#)

[Salt Lake City Police Department Procedure Manual: 1101.2.1 CONCEALED WEAPON PERMIT HOLDER](#)

[Salt Lake City Police Department Procedure Manual: 1101.2.3 DANGEROUS WEAPONS \(NON-FIREARM\)](#)

1101.4 REPORTS AND NOTIFICATIONS

All firearm and weapon violation responses, involving an actual weapon within a secure area, shall be documented in an initial report. Notification shall be made to the Transportation Security Administration (TSA) and FBI regardless of whether law enforcement action is taken or not.

1101.5 REVISIONS

Enacted: November 30, 2018

Police Escorts

1102.1 PURPOSE AND SCOPE

This policy provides guidance for Airport-assigned police officers who escort vehicles or persons inside restricted areas of the Airport. These areas include the Airport Operations Area (AOA), the Airport's sterile concourse areas, and other restricted areas of the Airport. Escorts may include dignitaries, law enforcement agencies, or others who do not have an Airport badge and/or ramp permit.

1102.2 POLICY

Airport-assigned police officers will follow Airport policy and protocols regarding the escort of vehicles into the AOA, as well as when escorting individuals into sterile or secure areas of the Airport.

1102.2.1 POLICE VEHICLE ESCORTS

- (a) Officers are allowed to escort vehicles through AOA vehicle gates for work-related purposes only.
- (b) Officers will inform all escorted vehicle occupants of the safety rules and expectations of driving in the AOA prior to entering the secure area.
- (c) Officers are responsible for maintaining direct control over all vehicles and occupants the entire time they are in the AOA.
- (d) Only two vehicles may be escorted at one time unless another authorized Airport vehicle is behind the escort.
- (e) Vehicles under police escort do not need a Vehicle Under Escort dash placard (see the Vehicle Escort Inspections Policy).

1102.2.2 COMPUTERIZED ACCESS SECURITY SYSTEM (CASS) DOORS

- (a) Airport Security Identification Display Area (SIDA) badged police officers are allowed to escort non-badged persons through Airport Computerized Access Security System (CASS) doors for work-related purposes only.
- (b) Examples of situations allowing an escort:
 - i. Victim/Witness of a crime assisting in the search for a suspect.
 - ii. An individual searching for a lost relative.
 - iii. Ambulance or emergency personnel.
- (c) The officer must keep the escorted person(s) with them and under their direct control at all times until the person is out of the sterile or escorted area.
- (d) Officers will monitor any tools or other items the escorted person has with them to ensure those items are not left in the sterile area.
- (e) Officers will ensure escorted persons do not hand off any items to passengers or any other person while being escorted in the sterile area.

Salt Lake City Police Department

SLCPD Policy Manual

SLCPD Policy Manual

Police Escorts

1102.2.3 PASSENGER SCREENING CHECKPOINT

- (a) Airport SIDA badged police officers are allowed to escort non-badged individuals through the passenger screening checkpoint for work-related purposes only. Non-badged individuals will be screened by TSA personnel prior to entering the sterile area.
- (b) Examples of situations allowing an escort:
 - i. Victim/Witness of a crime assisting in the search for a suspect.
 - ii. An individual searching for a lost relative.
 - iii. Ambulance or emergency personnel (not subject to screening if on a medical call for service).
- (c) Airport-assigned police officers escorting outside agency law enforcement personnel through the passenger screening checkpoint will contact a TSA Supervisor and have the escorted law enforcement personnel sign in as per protocol.

1102.2.4 ESCORTING BADGED EMPLOYEES

Officers will not escort badged employees into any sterile or secure areas of the airport without an official business purpose or without an exigent circumstance. An example of a business purpose is an employee who is being escorted to an area of the airport they do not normally work in and therefore do not have CASS access.

1102.3 REVISIONS

Enacted: November 30, 2018

Explosives Detection Canine Team Program

1103.1 PURPOSE AND SCOPE

This policy establishes guidelines for the use of single purpose Explosives Detection Canine (EDC) teams to augment law enforcement services to the community. It is established under the auspices of the Transportation Security Administration (TSA) National Explosives Detection Canine Team Program (NEDCTP).

1103.2 POLICY

It is the policy of the Salt Lake City Police Department's Airport Bureau that assigned NEDCTP EDC teams meet and maintain the appropriate level of proficiency in order to effectively and reasonably carry out legitimate law enforcement explosives intervention objectives.

1103.2.1 COOPERATIVE AGREEMENT

The Transportation Security Administration (TSA), in cooperation with Salt Lake City Corporation, has established an EDC program to aid in providing a safe environment for the traveling public and the community. Due to the sensitivity and responsibility of the program, a Statement of Joint Obligations (SOJO) between Salt Lake City Corporation and the TSA has been established in order to maintain a high degree of proficiency and competency of assigned Airport Police Bureau/ TSA certified EDC teams. It is the intent of the Salt Lake City Police Department Airport Bureau to fully comply with the TSA SOJO and view it as a partnership with the TSA in providing this valuable service.

1103.3 OPERATIONAL ASSIGNMENT AND UTILIZATION

Operational utilization of EDC teams will be in accordance with the TSA SOJO.

Use of an EDC team to resolve ETD/EDS alarms and other EDC responses will be in accordance with the TSA SOJO.

EDC teams may be assigned to assist and supplement other Bureaus of the police department (functioning primarily in assist or cover assignments), and they may be assigned by the Watch Commander to other Airport Bureau functions, such as routine calls for service, based on operational needs.

Canine teams should generally not be assigned to handle routine matters that will take them out of service for extended periods of time, and then only with the approval of the Canine Sergeant.

Foot patrol is important to the EDC program and will occur on a daily basis. EDC teams will accomplish foot patrol within view of the public for the purpose of increasing public awareness and providing a noticeable deterrent. Such foot patrols will include, over a period of time, a presence in operational areas of the Airport to include peak and off-peak hours.

1103.4 UNCERTIFIED - DECERTIFIED TEAMS

Utilization and training activities of an uncertified or deactivated EDC team will be in accordance with the current TSA SOJO.

Salt Lake City Police Department

SLCPD Policy Manual

SLCPD Policy Manual

Explosives Detection Canine Team Program

1103.5 CANINE TRAINER/SUPERVISOR (CANINE SERGEANT)

The Airport Police Bureau Canine Sergeant reports directly to a designated Airport Bureau Lieutenant or authorized designee. This Canine Sergeant position is a supervisory and training position.

The primary responsibility of the Canine Sergeant is to ensure the ongoing preparation and training of the unit. Duties include, but are not limited to:

- (a) Reviewing all canine training and utilization records to ensure compliance with policy and to identify training issues and other needs of the program.
- (b) Maintaining liaison with TSA/NEDCTP representatives.
- (c) Maintaining liaison with command staff and functional supervisors.
- (d) Maintaining liaison with other agency canine coordinators/supervisors.
- (e) Maintaining accurate records to document canine activities.
- (f) Recommending and overseeing the procurement of equipment and services for the canine teams.
- (g) Scheduling all canine related activities.
- (h) Scheduling and conducting regular training to maximize canine team capabilities.

1103.6 REQUEST FOR CANINE TEAMS

Patrol officers are encouraged to request the use of an EDC team if needed.

1103.6.1 ON-CALL RESPONSE

EDC teams will follow on-call response protocols if an EDC team is not on-duty during an event.

In order to maintain EDC team coverage for the Airport, all handlers will bid shifts and on-call weeks that are designed to provide maximum coverage during peak hours of operation. Shifts and on-call weeks will be bid on by Department seniority.

Handlers are issued vehicles, cellular telephones, and radios to ensure that EDC teams are available to respond to the Airport (24 hours a day, 7 days a week) on an on-duty or on-call basis.

At least one certified EDC team (on-duty or on-call) will maintain an airport response capability at all times. Minimum response time will be in accordance with the TSA SOJO. In the event that the designated on-call handler is unable to maintain the ability to respond, the handler shall notify the appropriate supervisory personnel. Supervisors will ensure the response capability is continuously maintained.

Handlers are authorized to trade assigned stand-by days and weeks amongst themselves. If a trade is made, it will be done in a minimum of 12 hour increments so as not to result in an increased cost to the Airport.

In the event that a stand-by period is traded or otherwise voluntarily relinquished, it is the responsibility of the originally scheduled handler to ensure that the Canine Sergeant, the

Salt Lake City Police Department

SLCPD Policy Manual

SLCPD Policy Manual

Explosives Detection Canine Team Program

appropriate Watch Commander, and the Airport Control Center is informed of the trade, and that the published stand-by schedule is changed accordingly.

While in an on-call status, canine handlers must be mentally and physically fit for duty.

While in an on-call status, canine handlers will not consume alcoholic beverages.

1103.6.2 OUTSIDE AGENCY REQUEST

All short notice requests for canine assistance from outside agencies must be approved by the Airport Police Bureau Canine Sergeant and Watch Commander. In the absence of the Canine Sergeant, the Watch Commander is the approving authority. The following will apply:

- (a) EDC teams are allowed to assist other law enforcement agencies for such things as bomb threats and precautionary searches provided that such assistance will not diminish the ability of the Airport Bureau to meet the requirements of the TSA SOJO.
- (b) EDC teams shall not be used for any assignment that is not consistent with this policy.
- (c) EDC handlers shall have the authority to decline an outside agency request should the handler deem the parameters of the request to be unsuitable or unsafe for the team, beyond the capability of the team, etc. The Canine Sergeant will be informed whenever an outside agency request is declined, and the reason for the declination.
- (d) Calling out an off-duty canine team will only be done when absolutely necessary.
- (e) Whenever a canine team responds off of Airport property, either on-duty, on-call, or off-duty, the following will be notified as soon as practicable:
 - 1. The on-duty Watch Commander
 - 2. The Airport Bureau Canine Sergeant
- (f) Normally, the on-duty canine team will respond to an approved, off airport request provided that the responding team has the capability to return to the Airport within 45 minutes of being notified to do so. The requesting agency will be advised of this time limitation. In any event, at least one team (on-duty or on-call) will maintain a 45 minute Airport response capability.
- (g) It shall be the responsibility of the canine handler to coordinate operations with the requesting agency personnel in order to minimize the risk of unintended injury.
- (h) It shall be the responsibility of the canine handler to complete all necessary reports.

1103.6.3 PUBLIC DEMONSTRATIONS

All public requests for a canine team demonstration shall be reviewed and, if appropriate, approved by the Airport Bureau Canine Sergeant prior to making any resource commitment. The Canine Sergeant is responsible for obtaining resources and coordinating involvement in the demonstration to include proper safety protocols. Canine handlers will not demonstrate any EDC work unless authorized to do so by the Canine Sergeant.

Salt Lake City Police Department

SLCPD Policy Manual

SLCPD Policy Manual

Explosives Detection Canine Team Program

1103.6.4 CANINES IN PUBLIC AREAS

Canine handlers will normally keep their assigned canine on-leash when in areas that allow access to the public. Exceptions to this rule would include specific law enforcement operations for which the canine is trained.

A canine shall not be left unattended in any area to which the public may have access.

1103.7 HANDLER SELECTION AND RETENTION

The following information outlines the general requirements for appointment to the position of Salt Lake City Police Department Airport Bureau EDC handler:

- (a) Minimum of two years experience as an Airport Bureau police officer.
- (b) There is no minimum or maximum term for retention in the assignment. General retention in the program will be 5 years, or the life of the assigned canine, provided that performance is acceptable and in accordance with the TSA Cooperative Agreement/SOJO.
- (c) Successful completion of an in-residence, 10-week technical training course at the Department of Defense (DOD) Dog Center, Lackland Air Force Base (AFB), San Antonio Texas.
- (d) Ability to obtain initial team certification by training for and passing a TSA administered training mission upon return from Lackland AFB.
- (e) Ability to maintain certification by successfully passing an annually recurring TSA canine evaluation.
- (f) Willing to accept complete responsibility for the safety, care, and feeding of a high value, live animal, 24 hours a day, 7 days a week.
- (g) Ability to develop and maintain professional working relationships while working productively in a small team environment (team player).
- (h) Ability to work independently, often without direct supervision.
- (i) Willing to handle Hazard Class/Division 1.1 commercial and military grade explosives.
- (j) Must own or rent a home with a yard large enough for the construction of an Airport provided 8x20 (approximate) concrete pad/kennel run.
- (k) As required by Salt Lake City Code Title 2, Chapter 2.54 (City Owned Motor Vehicles), must not reside farther than thirty five (35) miles from City limits.
- (l) Willing to maintain an on-call/standby status for a minimum of one week (seven days), every fifth week.
- (m) Ability to maintain an airport response capability when in an on-call status. The response capability is computed as the maximum total amount of time it takes to arrive at the SLC Airport from initial notification, not drive time alone. The response capability will be in accordance with the TSA SOJO.

When openings for an EDC Handler position occur, an appropriate application process will be announced.

Salt Lake City Police Department

SLCPD Policy Manual

SLCPD Policy Manual

Explosives Detection Canine Team Program

1103.8 HANDLER RESPONSIBILITIES

EDC handlers will maintain complete knowledge and a thorough understanding of the current TSA SOJO, and will comply with it at all times.

EDC handlers will maintain the health and welfare of their assigned canine and shall ensure that the canine receives proper nutrition, grooming, training, medical care, and that the canine is kept in a clean and safe environment at all times.

Except as required during appropriate deployment, the handler shall not expose the canine to any foreseeable and unreasonable risk of harm.

The handler shall maintain all department equipment under his/her control in a clean and serviceable condition. Required equipment includes:

- (a) 6' leash
- (b) 15' leash
- (c) Choke chain
- (d) Muzzle
- (e) Vet bag
- (f) Kennel
- (g) Dog house
- (h) Water bowl
- (i) Food bowl
- (j) Reward
- (k) Brush
- (l) Other equipment as determined by the Canine Supervisor.

Kennels and vehicles will be inspected daily to ensure that they are safe for the canine. Unsafe conditions will be corrected immediately. Defective equipment will be replaced or repaired.

Handlers shall permit the Canine Sergeant to conduct on-site inspections of affected areas of their homes as well as their canine vehicles to verify that conditions and equipment conform to this policy and the TSA SOJO.

Any changes in the living status of the handler that may affect the environment of the canine shall be reported to the Canine Sergeant as soon as possible.

When off-duty, the canine shall be appropriately secured at the handler's residence. When a canine is kenneled at the handler's residence, the kennel gate shall be secured with a lock.

Canines will not be kenneled at a location other than the handler's residence or the Airport kennel unless approved by the Canine Sergeant.

When off-duty, the handler shall not involve the canine in any law enforcement activity or official conduct unless approved in advance by the Canine Sergeant.

Salt Lake City Police Department

SLCPD Policy Manual

SLCPD Policy Manual

Explosives Detection Canine Team Program

Unless approved by the Canine Sergeant, a TSA canine will not be transported out of the local area. The local area is defined in its entirety as Salt Lake County, Davis County, Tooele County, Utah County, Weber County, Morgan County, Summit County, and Wasatch County.

Whenever a canine handler is off-duty for an extended number of days, it may be necessary to temporarily relocate the canine. In those situations, the handler shall give reasonable notice to the Canine Sergeant so that appropriate kenneling arrangements can be made.

Home and Airport kennels will be cleaned daily of waste, weeds, and debris. Food and water dishes will be washed and scrubbed. At a minimum, weekly care of the kennels will include a thorough cleaning and disinfecting of the entire kennel. Outside kennel areas and all training areas will be kept free of canine feces and foreign objects to prevent the spread of parasites, disease, and prevent injuries to the team.

All personnel will ensure kennel facility gates and doors are secured at all times when not in use.

Each handler, in coordination with the Canine Sergeant, is responsible for the level of proficiency and competence of their assigned canine in explosives detection. If problems arise, proper notification to the Canine Sergeant will be made. Corrective action will be taken immediately.

Handlers will comply with the current TSA "No Pet" policy.

1103.9 HANDLER COMPENSATION

Canine handlers shall be compensated in accordance with the applicable memorandum of understanding, City policy, or compensation plan.

1103.10 VETERINARY CARE

Canine handlers are responsible for routine care to include participating in semiannual examinations, disease prevention programs, diet and weight management programs, veterinarian provided training, etc., and medication of canines, if necessary, for different conditions or illnesses.

The Canine Sergeant will specify which veterinarian treatment facility is to be used for routine and emergency care based upon TSA, DOD, and servicing veterinarian recommendations and arrangements, and/or city contracts. The use of a non-specified veterinarian treatment facility for other than life threatening emergency care must be approved by the Canine Sergeant.

For other than recurring or routine veterinarian care, or life threatening emergency veterinarian care, the Airport Bureau Commander or designee must pre-approve any expenditure of government funds.

Handlers will obtain the weight of their assigned canine on a weekly basis. Any weight abnormalities will be reported to the Canine Sergeant.

The Canine Sergeant will maintain veterinarian treatment records and canine medical files in accordance with the current TSA SOJO.

Salt Lake City Police Department

SLCPD Policy Manual

SLCPD Policy Manual

Explosives Detection Canine Team Program

1103.11 OPERATION AND USE OF CANINE VEHICLE

Canine handlers will be provided with a police take-home vehicle for the purpose of transporting their assigned canine to and from their residence for regularly scheduled shifts, emergency responses, and other call-out situations.

Vehicles will be operated in a safe and prudent manner at all times, and in accordance with Salt Lake City Police and Salt Lake City Corporation vehicle policies and ordinances.

Canine handlers are responsible for the general maintenance and proper care and cleanliness of their assigned vehicle.

Repairs may not be made to a vehicle by any facility other than the Airport Vehicle Maintenance Shop unless otherwise approved.

Only approved fuel, lubricants, and additives will be used.

In the case of a vehicle malfunction resulting in a disabled vehicle, and an Airport tow truck is unavailable, the canine handler may have the vehicle relocated by the City-contracted towing service to the Airport Vehicle Maintenance Shop or other facility with the approval of the Canine Sergeant or on-duty Watch Commander.

If an assigned canine vehicle is placed out of service, the handler will operate the designated spare canine vehicle.

Canine vehicles will be cleaned and sanitized once per week, or more often as required. Cleaning will include vehicle exterior, vehicle interior, and the canine compartment. The cleaning and sanitizing of the canine compartment will include a thorough disinfecting with a veterinarian-approved disinfectant.

Unsecured or hazardous items will not be stored or transported within the canine compartment.

Canine handlers will accomplish a daily inspection of their assigned vehicle prior to it being operated. Any damage or discrepancies will be reported to the Canine Sergeant.

Canine vehicles will be properly equipped whenever operated. Each vehicle will be required to have the following equipment:

- (a) Service weapon
- (b) Police identification
- (c) Flashlight
- (d) Report forms
- (e) Flares
- (f) Portable radio
- (g) Cell phone
- (h) Canine first-aid kit

Salt Lake City Police Department

SLCPD Policy Manual

SLCPD Policy Manual

Explosives Detection Canine Team Program

Unofficial window decals, ornaments, bumper stickers, signs, and pictures attached to either the interior or exterior of the vehicle are prohibited.

Canine vehicles will only be left unattended and idling for the purpose of providing a safe and comfortable environment for the canine.

Unattended canine vehicles will be locked at all times. All windows and doors shall be secured in such a manner as to prevent unauthorized access to the interior of the vehicle.

When a canine vehicle containing a canine is left unattended, the handler shall ensure that the vehicle environment remains inhabitable for the canine.

Whenever a canine vehicle is left unattended and idling within the Airport Operations Area (AOA), the transmission will be placed in park, the parking brake will be engaged, the vehicle will be locked, and one wheel will be chocked.

Police equipment will not be left in plain view whenever the vehicle is left unattended.

When the vehicle is parked overnight at the officer's residence, the officer's service weapon(s) may be left secured in a locked vehicle only if the vehicle is parked inside of a locked garage. If the vehicle is parked outdoors or in a carport, the officer's service weapon(s) will be removed from the vehicle and secured within the officer's residence.

When responding to an emergency (such as a bomb threat), the canine handler will proceed in a safe and prudent manner. Lights and siren will only be used when deemed necessary.

1103.12 TRAINING AND CERTIFICATION

EDC teams will be trained and certified in accordance with the current TSA SOJO and TSA Evaluation Guidelines, as published.

Priority will be given to explosives detection training. Handlers will not normally be assigned to work a rotation shift in order to provide coverage when other officers are unable to provide shift coverage. Emergency, special, and unique situations may dictate otherwise.

The Canine Sergeant will ensure that each canine team receives the necessary amount of TSA mandated proficiency training time as required by the SOJO. Training will be developed to reflect the activities undertaken at the Salt Lake City International Airport.

Proficiency training exercises will be objective based. Requirements for each canine team may vary, and are dependent on the informed and educated assessment made by the Canine Sergeant and handlers. Proficiency training objectives are based upon each team's strengths, weaknesses, past evaluation results and problems.

Appropriate training or other canine activities should be conducted within view of the public for the purpose of increasing public awareness of the EDC team program and to provide a noticeable deterrent. Training should occur in operational areas of the Airport to include peak and off-peak hours.

Salt Lake City Police Department

SLCPD Policy Manual

SLCPD Policy Manual

Explosives Detection Canine Team Program

Training areas will vary as much as possible. Care will be exercised to ensure that bystanders and the public are not subjected to any harm.

In the absence of the Canine Sergeant, handlers will conduct self-initiated training exercises to the maximum extent possible with consideration given to other duties and responsibilities.

All training of EDCs is to be conducted with TSA-approved explosive substances only. Under no circumstances are canine personnel allowed to cross-train or train a canine on any substance not approved by the TSA.

Handlers shall determine and conduct the appropriate amount of obedience training needed to ensure proper control and recall of their canine. Handlers will conduct obedience training in accordance with the current TSA SOJO "Program Obedience Guidelines", as published.

Local canine training, TSA canine training, TSA canine assessments, and TSA canine evaluations, etc., will be applied to annual POST training hour requirements. The Canine Sergeant will compile a summary of accumulated training and evaluation search time for each assigned canine team on a quarterly basis. The actual amount of search time accumulated during these events will be applied.

1103.12.1 TSA EVALUATIONS

Canine personnel are required to participate in TSA evaluations in accordance with current TSA Evaluation Guidelines and TSA SOJO.

If a canine team fails two consecutive TSA evaluations due to a handler failure on both occasions, a review of handler performance will be completed for the purpose of determining if the handler is to be retained within the program.

1103.12.2 DOCUMENTATION OF TRAINING AND UTILIZATION

Complete and accurate training and utilization records will be maintained for each canine team in accordance with the current TSA SOJO.

Field documentation of deployments and training exercises will reflect the requirements of the TSA canine web site on-line data collection system (CWS).

Whenever a training exercise is conducted on any aircraft in which a TSA Canine Explosives Training Aid (CETA) is placed (both interior and exterior), the information concerning that particular exercise will be entered into the TSA K-9 Training Aid Reporting System (KTARS) in accordance with the TSA SOJO.

1103.12.3 TRAINING AIDS AUTHORIZATION AND CONTROL

See the associated Explosives Detection Canine Team Training Aids Authorization and Control Procedure.

1103.13 REVISIONS

Enacted: November 30, 2018

Airport Employee Security Violations and Procedural Incidents

1104.1 PURPOSE AND SCOPE

The Airport Security Plan (ASP) is based on Federal Aviation Regulation 1542 and is vital for the protection of the Salt Lake City International Airport and its passengers. This policy provides guidance for officers to ensure the ASP is followed and enforced.

1104.2 POLICY

Officers will investigate Airport employee security violations and procedural incidents that are brought to their attention. Security violations and procedural incidents will be enforced according to Airport policy. Enforcement action may range from a verbal warning and explaining the importance of the policy, to the confiscation of an employee's Airport Security Identification Display Area (SIDA) badge, and/or a citation or physical arrest.

1104.3 PROCEDURAL INCIDENTS AND SECURITY VIOLATIONS

Officers will determine the validity of any procedural incident or security violation that they are made aware of and take appropriate action.

1104.3.1 DEFINITION OF PROCEDURAL INCIDENTS

Procedural incidents are situations where an employee does not maliciously or intentionally commit a security violation and where the incident would not allow a breach of Airport security.

The following examples are a partial list of what would be considered procedural incidents:

- (a) Driving a vehicle into the AOA without proper company insignias, but the the driver is properly badged and the vehicle has a ramp permit.
- (b) An employee attempts to enter the AOA not knowing their badge has recently expired.
- (c) An employee's badge is not properly displayed, but is in their immediate possession.
- (d) Scratched badge, fading of badge, etc. (no falsification intended).

1104.3.2 DEFINITION OF SECURITY VIOLATIONS

Security violations are incidents where an employee commits an act that could allow an unauthorized individual to enter into a restricted area of the Airport, including any incident where an employee accesses a restricted area that they are not authorized to be in. Incidents that are, or may be, detrimental to the security of the Airport would also be considered a security violation.

The following examples are a partial list of what would be considered employee security violations:

- (a) An employee loaning their badge to another person so the other person can access a restricted area of the Airport.
- (b) Failure to possess a badge while in the AOA or other restricted area.

Salt Lake City Police Department

SLCPD Policy Manual

SLCPD Policy Manual

Airport Employee Security Violations and Procedural Incidents

- (c) An employee escorting a badged person who is not in possession of their badge. Both the employee doing the escort and the employee not in possession of their badge would be in violation.
- (d) Failure of an employee to enroll their Computerized Access Security System (CASS) pin when entering onto the ramp from the sterile area.
- (e) Leaving a vehicle gate, jetway door, or any access leading to a restricted area open without being properly monitored.
- (f) A vehicle or employee “piggy-backing”, or allowance of “piggy-backing”, when entering a secure area.
- (g) An employee escorting without escorting privileges (no “E” on their badge).
- (h) A vehicle in the AOA without markings and without a ramp permit.
- (i) Blocking doors or gates open without monitoring them.
- (j) Bypassing screening when traveling.

1104.4 PROCEDURAL INCIDENT AND SECURITY VIOLATION PROTOCOLS

Officers shall follow proper procedure when dealing with procedural incidents and security violations.

[Salt Lake City Police Department Procedure Manual: 1102.2.1 PROCEDURAL INCIDENT PROTOCOLS](#)

[Salt Lake City Police Department Procedure Manual: 1102.2.2 SECURITY VIOLATION PROTOCOLS](#)

[Salt Lake City Police Department Procedure Manual: 1102.2.3 CITATION OR ARREST](#)

1104.5 SECURITY PROTOCOLS AND LEASED/RENTED HANGERS

Leased and rented general aviation aircraft hangars are located on the east side of the Airport's AOA. Badged hangar tenants may escort other vehicles through an east side vehicle gate directly to their leased or rented hangar without a vehicle inspection being performed as outlined in the Vehicle Escort Inspections Policy, but only under the following circumstances:

- (a) The person performing the escort has a valid Airport badge with escort privileges and has an east side leased or rented hangar at the Airport.
- (b) The person performing the escort uses the vehicle gate closest to their hangar.
- (c) The person performing the escort is escorting a vehicle to his/her leased or rented hangar for a legitimate purpose (i.e., flying his/her plane, performing maintenance work, etc.).
- (d) The person performing the escort may not escort any person who possesses an Airport badge that is not valid (i.e., expired, reported as lost, etc.), or a person who possesses an Airport badge that does not allow access to the AOA.

A security violation exists if the person performing an escort violates any of the above circumstances.

Salt Lake City Police Department

SLCPD Policy Manual

SLCPD Policy Manual

Airport Employee Security Violations and Procedural Incidents

1104.6 REVISIONS

Enacted: November 30, 2018

Vehicle Escort Inspections

1105.1 PURPOSE AND SCOPE

This policy provides guidance for officers when completing physical vehicle inspections on vehicles that are being escorted by Airport tenants into the Airport Operations Area (AOA).

1105.2 POLICY

Officers will follow Airport and Department protocols when completing vehicle escort inspections, to include:

- (a) Inquire from the escorting employee the purpose of the escort.
- (b) Ensure the Airport employee performing the escort has a valid Security Identification Display Area (SIDA) badge and escort privileges.
- (c) Ensure the escorting vehicle has a ramp permit along with the proper vehicle insignias.
- (d) Complete a computer check on the driver/occupants of the escorted vehicle.
- (e) Physically inspect the escorted vehicle for any item(s) that appear suspicious or may be of danger to the Airport. Take the appropriate action and contact a supervisor if illegal or suspicious items are located.
- (f) Complete and review a "Vehicle Under Escort" form with the employee doing the escort and the person being escorted to ensure the Airport employee and the person being escorted know the escort procedures as outlined on the back of the form. (All escorted vehicles entering the secure area must have a Vehicle Under Escort form. Police escorts are exempt unless at some point during the escort the escorted vehicle will be left unattended.)
- (g) Ensure the driver being escorted knows to place the Vehicle Under Escort form on the vehicle's dashboard in plain view at all times while in the SIDA area.

Officers shall contact the on-duty Sergeant if there are any concerns about an escort.

1105.3 REVISIONS

Enacted: November 30, 2018

Airport Operations Area (AOA) Safety Violations

1106.1 PURPOSE AND SCOPE

This policy provides guidance for officers when confronted with safety violations inside the Airport Operations Area (AOA). The policy provides a process to increase safety through identifying unacceptable and unsafe behavior by employees that have access to the AOA. It includes a method of tracking violations as well as a system for the Airport to correct these hazardous and unsafe behaviors through a progressive point system that is based on the severity of the violation. It also provides administrative corrective actions for badge holders who have multiple or severe violations that will accumulate on an individual's Computerized Access Security System (CASS) record over a rolling 24-month period.

Officers should keep in mind that response to AOA safety violations is largely governed by Airport Operations and can change. Officers are expected to act in each situation according to current training. The Airport Bureau Commander, or designee, is responsible for interfacing with Airport Operations on a biannual basis to manage updates to this policy.

1106.2 POLICY

It is the policy of the Salt Lake City Police Department to recognize and take appropriate action when AOA safety violations are committed.

1106.3 GENERAL

The Airport Operations Area (AOA) is considered private property and is not open to the general public. The Airport's Safety Enforcement Policy provides for enforcement of vehicle and pedestrian violations inside the AOA where many State Code violation sections do not apply (e.g., speeding, failure to stop at a stop sign, etc.).

The Progressive Point System is tracked and maintained in the employee's CASS record and can be accessed through the Airport's Control Center.

1106.3.1 POINT THRESHOLDS AND PENALTIES

4 points: Remedial computer training within 7 calendar days of offense.

6 points: One day (24 hours) suspension of airport issued ID badge.

9 points: Three day (72 hours) suspension of airport issued ID badge.

12 points: Revocation of Airport-issued ID badge. The person may request an appeal by submitting a written request within 7 days of the violation. A person who has had an ID badge revoked and has either declined to appeal or who has had the revocation upheld on appeal, may not apply for an Airport ID badge for two years.

Salt Lake City Police Department

SLCPD Policy Manual

SLCPD Policy Manual

Airport Operations Area (AOA) Safety Violations

1106.4 SAFETY VIOLATION ENFORCEMENT

When an officer observes a safety violation within the AOA, the officer should stop the employee and explain the violation to them (e.g., stop sign violation, speeding, not driving on the roadway, etc.) and take appropriate action to discourage the reoccurrence of the violation.

The officer should check with the Control Center and inquire of any previous violations and the number of offense points the employee has recorded in their CASS record.

If the violator has less than 4 offense points, including the current safety violation, the officer may warn the person and inform them of the consequences if stopped for any further safety violations. The officer will ensure the Control Center logs the violation and offense points associated with it. There is no required additional action on the officer's part unless other reportable violations are involved.

If the violator has reached 4 offense points or more, the officer will contact the Airport's Duty Manager. The Duty Manager will be informed of the incident and the violator's offense points. The Duty Manager will assist in determining the proper course of action, if any, according to the Violation Point Offense Chart. The Duty Manager will arrange for any necessary notifications.

The officer will have the Control Center log the safety violation, including the location and how many points were associated with the current safety violation. There is no required additional action on the officer's part, unless other reportable violations are involved.

Nothing prevents an officer from using their discretion and warning an employee for a minor offense without having the incident attached to their CASS record.

1106.5 REVISIONS

Enacted: November 30, 2018

Title 16.60 Civil Code Violations

1107.1 PURPOSE AND SCOPE

Generally, police officers do not enforce civil code violations. Airport Title 16.60 of the Salt Lake City Ordinances and Traffic Code are civil in nature and deal mainly with ground transportation vehicle violations, some Airport parking violations, and other miscellaneous Airport sections. This policy provides guidelines for officers on how to enforce Airport Civil Code Title 16.60 violations, if necessary.

1107.2 POLICY

If an officer believes a civil code citation is warranted and cannot locate an alternative criminal section, they may have the Control Center dispatch a Landside Operations Specialist to their location and request they complete the Title 16.60 civil code citation. Landside Operations Specialists have the authority to complete civil code citations, but are limited on which sections they can issue a citation for.

In lieu of requesting an Airport Landside Operations Specialist respond, an officer may contact the on-duty Airport Bureau Sergeant, who has a civil code citation book, and complete a citation.

1107.2.1 COMPLETING CIVIL CODE CITATIONS

Instructions on how to complete a civil code citation are on the front and back cover of the civil code citation book. The officer will hand write the citation and keep the bottom copy of the citation for their records. The citation book contains a separate page that the officer must complete. The separate page and the remaining copies of the citation will be placed in the office clerk's report inbox. The violator does not receive a copy of the citation; they will be notified by mail of any further proceedings. For this reason, it is important that the officer ensures the violator's information on the citation is correct and accurate.

The Airport Bureau's office clerk will make a copy of the citation for an office record. The remaining copies will be forwarded to the Salt Lake City Ground Transportation Department.

1107.3 REVISIONS

Enacted: November 30, 2018

Airport Closed Circuit Video Camera System

1108.1 PURPOSE AND SCOPE

This policy provides guidance on usage of the Salt Lake City Airport's closed circuit video camera system, as well as the release of captured video footage.

This policy only applies to Salt Lake City Airport assigned police employees. It does not apply to any other mobile audio/video systems, covert audio/video systems, or any other image-capturing devices that may be utilized by the Department.

1108.2 POLICY

Police officers will follow Airport and Department policy protocols regarding the usage, recording, and releasing of any Airport camera footage.

1108.2.1 OPERATIONAL GUIDELINES

Recorded video may be used for a variety of purposes, including criminal investigations, evidence, potential liability issues, monitoring areas of criminal concern, etc. Recorded video is for work-related purposes only.

Officers may review and obtain video recordings, provided it is for an operational requirement or need.

1108.2.2 VIDEO SUPERVISION

A supervisor will be advised anytime an officer desires to view video recordings captured on the Airport's closed circuit video camera system. Supervisors will monitor video surveillance access and usage by officers to make sure members are operating within department policy and applicable laws.

1108.2.3 RELEASING VIDEO

Officer requests to receive video footage must be approved by the officer's supervisor. The Control Center will e-mail the officer's supervisor a Video Release Form for approval. Once the form is signed by the supervisor and sent back to the Control Center, the video will be released to the officer. [See attachment: Consent to Release Video Form - Internal.pdf](#)

1108.2.4 EVIDENTIARY INTEGRITY

All downloaded and retained media shall be treated in the same manner as other evidence. Officers are not allowed to obtain video footage for their personal use.

1108.3 REVISIONS

Enacted: November 30, 2018

Aircraft Accidents within the Airport Operation Area (AOA)

1109.1 PURPOSE AND SCOPE

The purpose of this policy is to provide department members with guidelines for handling aircraft accidents within the Airport's "Airport Operations Area" (AOA). Refer to the Aircraft Accidents Policy for guidelines pertaining to aircraft accidents outside of the AOA.

This policy does not supersede, and is supplementary to, applicable portions of the Crime and Disaster Scene Integrity Policy, Emergency Management Plan Policy, and Hazardous Material Response Policy.

1109.1.1 DEFINITIONS

Definitions related to this policy include:

Aircraft - Any fixed wing aircraft, rotor craft, balloon, blimp/dirigible or glider that is capable of carrying a person or any unmanned aerial vehicle other than those intended for non-commercial recreational use.

Airport Operations Area (AOA) - The fenced-in restricted area of the Airport primarily used for landing, takeoff, or surface maneuvering of aircraft and related activities. Only approved/badged individuals are allowed into the AOA. The AOA is not open to the public and there is no public access. The AOA is considered private property and does not fall under state DI9 reporting guidelines.

1109.2 POLICY

It is the policy of the Salt Lake City Police Department to provide an appropriate emergency response to aircraft accidents. This includes emergency medical care and scene management. The size of the aircraft, severity of the crash, passengers on board, and other factors may determine the level and type of response.

1109.3 ARRIVAL AT SCENE

Adjacent Aircraft Movement Areas may still be active. Officers, or other authorized members tasked with initial scene management, should coordinate initial movement and approach to the scene in conjunction with Airport Operations personnel to establish an inner and outer perimeter in order to:

- (a) Protect persons and property.
- (b) Prevent any disturbance or further damage to the wreckage or debris, except to preserve life or rescue the injured.
- (c) Preserve ground scars and marks made by the aircraft.
- (d) Manage the admission and access of public safety and medical personnel to the extent necessary to preserve life or to stabilize hazardous materials.

Salt Lake City Police Department

SLCPD Policy Manual

SLCPD Policy Manual

Aircraft Accidents within the Airport Operation Area (AOA)

- (e) Maintain a record of persons who enter the accident site.
- (f) Implement a Unified Incident Command System (ICS).

1109.4 INJURIES AND CASUALTIES

When an aircraft accident occurs within the boundaries of the AOA, the Fire Department will respond. The Fire Department's primary role is the rescue and treatment of the injured. The Police Department's role includes scene security, criminal investigation, documentation, support to the Fire Department, and other related tasks. Police officers should address emergency medical issues as trained.

If there are casualties, coordination with the National Transportation Safety Board (NTSB) is required before the removal of bodies. If that is not possible, the scene supervisor should ensure documentation and photographs of any scene disturbances, including cockpit switch/control positions and instrument/gauge panel readings.

1109.5 CONTROLLING ACCESS AND SCENE AUTHORITY

Prior to NTSB arrival, scene access should be limited to authorized personnel from the:

- (a) FAA.
- (b) Fire department, EMS, or other assisting law enforcement agencies.
- (c) Medical Examiner if applicable.
- (d) Air Carrier/Operators investigative teams with NTSB approval.
- (e) Appropriate branch of the military, when applicable.
- (f) Other emergency services agencies (e.g., hazardous materials teams, biohazard decontamination teams, fuel recovery specialists, explosive ordnance disposal specialists).

The NTSB has primary responsibility for investigating accidents involving civil aircraft. In the case of a military aircraft accident, the appropriate branch of the military will have primary investigation responsibility.

After the NTSB or military representative arrives on-scene, the efforts of this department will shift to a support role for those agencies.

If NTSB or a military representative determines that an aircraft accident does not qualify under its jurisdiction, the on-scene department supervisor should ensure the accident is still appropriately investigated and documented.

1109.6 APPROACHING THE AIRCRAFT

The Fire Department has the responsibility of ensuring the aircraft is safe to approach after an accident. Officers should wait until the aircraft has been deemed safe before approaching it.

1109.7 DANGEROUS MATERIALS

Members should be aware of potentially dangerous materials that might be present. These may include, but are not limited to:

Salt Lake City Police Department

SLCPD Policy Manual

SLCPD Policy Manual

Aircraft Accidents within the Airport Operation Area (AOA)

- (a) Fuel, chemicals, explosives, biological or radioactive materials, and bombs or other ordnance.
- (b) Pressure vessels, compressed gas bottles, and accumulators.
- (c) Fluids, batteries, flares, and igniters.
- (d) Evacuation chutes, ballistic parachute systems, and composite materials.

1109.8 NOTIFICATIONS

Notification has to be made to the NTSB before the aircraft can be moved, along with the Federal Aviation Administration (FAA), and when applicable, the appropriate branch of the military.

Salt Lake City Police Department Procedure Manual: 411.2 NTSB Notification

Salt Lake City Police Department Procedure Manual: 411.3 FAA Notification

1109.9 DOCUMENTATION

All aircraft accidents occurring within the AOA shall be documented. Documentation should include the date, time, and location of the incident; investigation details; any witness statements, if taken; the names of SLCPD members deployed to assist; other City resources that were utilized; and cross reference information to other investigating agencies. Suspected criminal activity should be documented in an appropriate report. The Airport's "Aircraft Mishap Report Checklist" should be completed and attached to the report. The officer can have the pilot, if able, complete the form as long as the officer ensures it is as complete as possible.

1109.9.1 PHOTOGRAPHS

Complete photographs of the aircraft and surrounding incident area should be taken. Photographs of the cockpit's instrument panel are important to show the position of the aircraft's Master, Ignition, and ELT switches, etc.

1109.9.2 WRECKAGE

When reasonably safe, members should:

- (a) Obtain the aircraft registration number (N number) and note the type of aircraft.
- (b) Ascertain the number of casualties.
- (c) Obtain photographs or video of the overall wreckage, including the cockpit and damage, starting at the initial point of impact, if possible, and any ground scars or marks made by the aircraft.
 - 1. Military aircraft may contain classified equipment and therefore shall not be photographed unless authorized by a military commanding officer (18 USC § 795).
- (d) Secure, if requested by the lead authority, any electronic data or video recorders from the aircraft that became dislodged or cell phones or other recording devices that are part of the wreckage.
- (e) Acquire copies of any recordings, including Airport video cameras, that may have captured the incident.

Salt Lake City Police Department

SLCPD Policy Manual

SLCPD Policy Manual

Aircraft Accidents within the Airport Operation Area (AOA)

1109.9.3 WITNESSES

Members shall contact witnesses (i.e., passengers, airline employees, etc.) and should obtain:

- (a) The location of the witness at the time of his/her observation relative to the accident site.
- (b) A detailed description of what was observed or heard.
- (c) Any photographs or recordings of the accident witnesses may be willing to voluntarily surrender.
- (d) The names of all persons reporting the accident, even if not yet interviewed.

Many actions taken will depend on the size, severity, and location of the crash. Witnesses should complete a written witness statement if possible.

1109.10 MEDIA RELATIONS

The Public Information Officer (PIO) should coordinate a response to the media with the Airport PIO. Any release of information regarding details of the accident itself should be coordinated with the NTSB or other authority who may have assumed responsibility for the investigation.

Depending on the type of aircraft, the airline or the military may be responsible for family notifications and the release of victims' names. The PIO should coordinate with other involved entities before the release of information.

1109.11 REVISIONS

Enacted November 30, 2018

Airport Operations Area (AOA) Vehicle Collisions (Including with Aircraft)

1110.1 PURPOSE AND SCOPE

This policy is to ensure officers properly investigate and report vehicle collisions that occur inside the Airport Operations Area (AOA). The AOA is considered private property and does not fall under state DI9 reporting guidelines.

1110.1.1 DEFINITION

Airport Operations Area (AOA) - The fenced-in restricted area of the Airport used for landing, takeoff, or surface maneuvering of aircraft and related activities. Only authorized badged individuals are allowed inside the AOA. The AOA is not open to the public and there is no public access.

1110.2 VEHICLE ACCIDENT REPORTING GUIDELINES

1110.2.1 VEHICLE V. VEHICLE

Traffic collisions involving two or more vehicles do not require a DI-9 if the collision occurred within the fenced-in property of the AOA unless instructed by a supervisor. Damage severity or injuries do not play a factor in the type of report written.

All applicable entities and linkage factors shall be completed in an initial report. The report, along with standard details, shall include:

- (a) Damage to vehicle(s).
- (b) Driver-contributing circumstances (e.g., looking away, talking on cell phone, driving too fast for conditions, vehicle equipment, inattentiveness, etc.).
- (c) Approximate vehicle speeds and how speed was determined.
- (d) Driver, passenger, and/or witness statements, including witness statement forms.
- (e) Passenger seating positions, if applicable.
- (f) Insurance company information.
- (g) Photographs of involved vehicles, and/or property, including close-up and distant photographs from different angles, as well as photographs of injuries if possible.
- (h) A diagram should be completed on injury traffic collisions and/or traffic collisions involving severe damage. The diagram shall be attached to the initial report.
- (i) Available video footage.
- (j) The NCIC codes of 7399-1 (Medical), or 7399-4 (Industrial Accident), shall be included as secondary NCIC codes if injuries occurred.

Salt Lake City Police Department

SLCPD Policy Manual

SLCPD Policy Manual

Airport Operations Area (AOA) Vehicle Collisions (Including with Aircraft)

1110.2.2 VEHICLE V. STATIONARY OBJECT (JET BRIDGE, SKYBRIDGE, ROLL UP DOOR, ETC.)

Accidents involving a vehicle v. stationary property shall be completed using NCIC 2901-0 (Damage Property Business) unless instructed otherwise by a supervisor. If injuries are involved or the damage is severe, NCIC 2901-0 is still used as the primary NCIC code. An exception would be if the driver is intoxicated; the primary NCIC code would be for DUI, with NCIC 2901-0 included as a secondary NCIC code.

An initial report is required. The report, along with standard details, shall include:

- (a) Damage to vehicle(s).
- (b) Driver-contributing circumstances (e.g., looking away, talking on cell phone, driving too fast for conditions, vehicle equipment, inattentiveness, etc.).
- (c) Approximate vehicle speeds and how speed was determined.
- (d) Driver, passenger, and/or witness statements, including witness statement forms.
- (e) Passenger seating positions, if applicable.
- (f) Insurance company information.
- (g) Photographs of involved vehicles, and/or property, including close-up and distant photographs from different angles, as well as photographs of injuries if possible.
- (h) A diagram should be completed on injury traffic accidents and/or traffic accidents involving severe damage. The diagram shall be attached to the initial report.
- (i) Available video footage.
- (j) The NCIC codes of 7399-1 (Medical), or 7399-4 (Industrial Accident), shall be included as secondary NCIC codes if injuries occurred.

1110.2.3 VEHICLE V. PARKED AIRCRAFT

Collisions involving a moving vehicle v. a parked aircraft will be completed using NCIC 5499-0 (Traffic Free Text).

An initial report is required. The report, along with standard details, shall include:

- (a) Damage to vehicle(s).
- (b) Driver-contributing circumstances (e.g., looking away, talking on cell phone, driving too fast for conditions, vehicle equipment, inattentiveness, etc.).
- (c) Approximate vehicle speeds and how speed was determined.
- (d) Driver, passenger, and/or witness statements, including witness statement forms.
- (e) Passenger seating positions, if applicable.
- (f) Insurance company information.
- (g) Photographs of involved vehicles, and/or property, including close-up and distant photographs from different angles, as well as photographs of injuries if possible.

Salt Lake City Police Department

SLCPD Policy Manual

SLCPD Policy Manual

Airport Operations Area (AOA) Vehicle Collisions (Including with Aircraft)

- (h) A diagram should be completed on injury traffic collisions and/or traffic collisions involving severe damage. The diagram shall be attached to the initial report.
- (i) Available video footage.
- (j) The NCIC codes of 7399-1 (Medical), or 7399-4 (Industrial Accident), shall be included as secondary NCIC codes if injuries occurred.

1110.2.4 COLLISIONS INVOLVING DEATH OR PROBABLE DEATH

If any of the above collisions involve death or probable death, the applicable portion of the Traffic Collision Reporting Policy shall be followed.

1110.3 TAXING AIRCRAFT V. VEHICLE OR STATIONARY OBJECT

The Aircraft Accidents within the Airport Operations Area (AOA) Policy THE AIRPORT'S "AIRPORT OPERATIONS AREA" will be followed if a taxiing aircraft hits a vehicle or stationary object.

1110.4 REVISIONS

Enacted: November 30, 2018

Aircraft Laser Incidents

1111.1 PROCEDURES AND SCOPE

This policy provides guidance to police officers on how to investigate incidents where an aircraft has been hit/targeted with a laser beam while in flight.

1111.2 POLICY

It is the policy of this department to investigate and document reported aircraft laser incidents and to make proper notifications.

1111.3 LASER INCIDENT RESPONSE AND REPORTING

The following guidelines will be adhered to when investigating laser incidents.

1111.3.1 PILOT DESIRES NO POLICE RESPONSE

When the Control Center is contacted regarding a laser incident, the pilot will be asked if a police response is desired. If a police response is not desired, the Control Center will document the call in the CAD as an information report only. An officer will not be dispatched and no notifications will be made.

1111.3.2 PILOT DESIRES POLICE RESPONSE

When the Control Center is contacted regarding a laser incident and the pilot requests a police response, a police officer will be dispatched to the aircraft's arrival gate to interview the pilot. The officer will obtain a case number for a suspicious circumstances report, complete a Laser Incident Questionnaire form with the pilot/first officer, and complete an initial report. The Laser Incident Questionnaire form will be scanned into the officer's report.

The law enforcement jurisdiction where the pilot determined the laser incident occurred from will be contacted. They will be asked to patrol check the area for possible suspect(s).

If a suspect is located, the jurisdiction will be asked to obtain all pertinent information from the suspect and to complete an information report. The FBI will be contacted to determine if they desire to respond for further investigation of the incident before the suspect is released. The outside agency's case number will be included in the initial officer's report.

If no suspect is located, no further action will be required on the part of the responding agency.

The FBI will be notified of all laser incidents where officers respond, whether a suspect is located or not. All notifications will be documented in the initial report.

1111.3.3 OFFICER RESPONSE WITH NO CONTACT

When an officer is dispatched to a laser incident, and upon arrival the pilot cannot be located, the incident will be treated as a non-police response. The Control Center will document the incident in the CAD as an information report only and no notifications will be made. No report will be required from the officer.

Salt Lake City Police Department

SLCPD Policy Manual

SLCPD Policy Manual

Aircraft Laser Incidents

1111.3.4 DELAYED REPORTING

If a pilot reports a laser incident at a later time and wishes to file a police report, the Control Center will document the incident in the CAD as an information report only and no notifications will be made. An officer will not be dispatched. The exception to this would be if the pilot sustained injuries from the laser incident.

1111.4 REVISIONS

Enacted November 30, 2018

Unmanned Aircraft (UA) Incidents

1112.1 PURPOSE AND SCOPE

This policy provides guidance for Airport assigned police officers regarding when an in-flight aircraft pilot reports the sighting or interference of an unmanned aircraft (UA), commonly referred to as a drone.

1112.2 POLICY

The department will investigate all situations where a UA is reported to have interfered with an in-flight aircraft, or has been seen in close proximity to an in-flight aircraft.

1112.3 UA INCIDENT RESPONSE AND REPORTING

The following guidelines will be adhered to when investigating UA sightings or interference from UAs.

1112.3.1 PILOT DESIRES NO POLICE RESPONSE

When the Control Center is contacted regarding a UA sighting by an in-flight aircraft pilot, the pilot will be asked if a police response is desired. If a police response is not desired, the Control Center will document the call as an information report only. An officer will not be dispatched and no notifications will be made.

1112.3.2 PILOT DESIRES A POLICE RESPONSE

When the Control Center is contacted regarding a UA sighting by an in-flight aircraft pilot, and the pilot requests a police response, a police officer will be dispatched to the aircraft's arrival location to interview the pilot. If the officer determines there was no interference with the aircraft, the officer will generate a log entry with the Control Center. No other action is required of the officer.

If the officer determines there was UA interference with the in-flight aircraft, the officer will obtain a case number for suspicious circumstances, and complete an initial report of the incident listing all details.

The law enforcement jurisdiction where the pilot determined the UA interference occurred will be contacted as soon as possible after the incident. The jurisdiction will be asked to patrol check the determined area for possible suspect(s) and to inform this department of any detained suspect(s).

If a suspect is located, the jurisdiction will be asked to obtain all pertinent information from the suspect and to complete an information report. The FBI will be contacted to determine if they desire to respond for further investigation of the incident before the suspect is released. The outside agency's case number shall be included in the officer's report. If no suspects are located, no further action will be required on the part of the responding agency.

1112.4 NOTIFICATIONS

The FBI will be notified of all reported UA incidents where officers respond and determine flight interference occurred.

Salt Lake City Police Department

SLCPD Policy Manual

SLCPD Policy Manual

Unmanned Aircraft (UA) Incidents

1112.5 REVISIONS

Enacted: November 30, 2018

Attachments

SLCPD Org Chart 11.9.18.pdf

Salt Lake City Police Department Organization Chart

Mike Brown - Chief of Police

Current as of: 09 NOV 2018

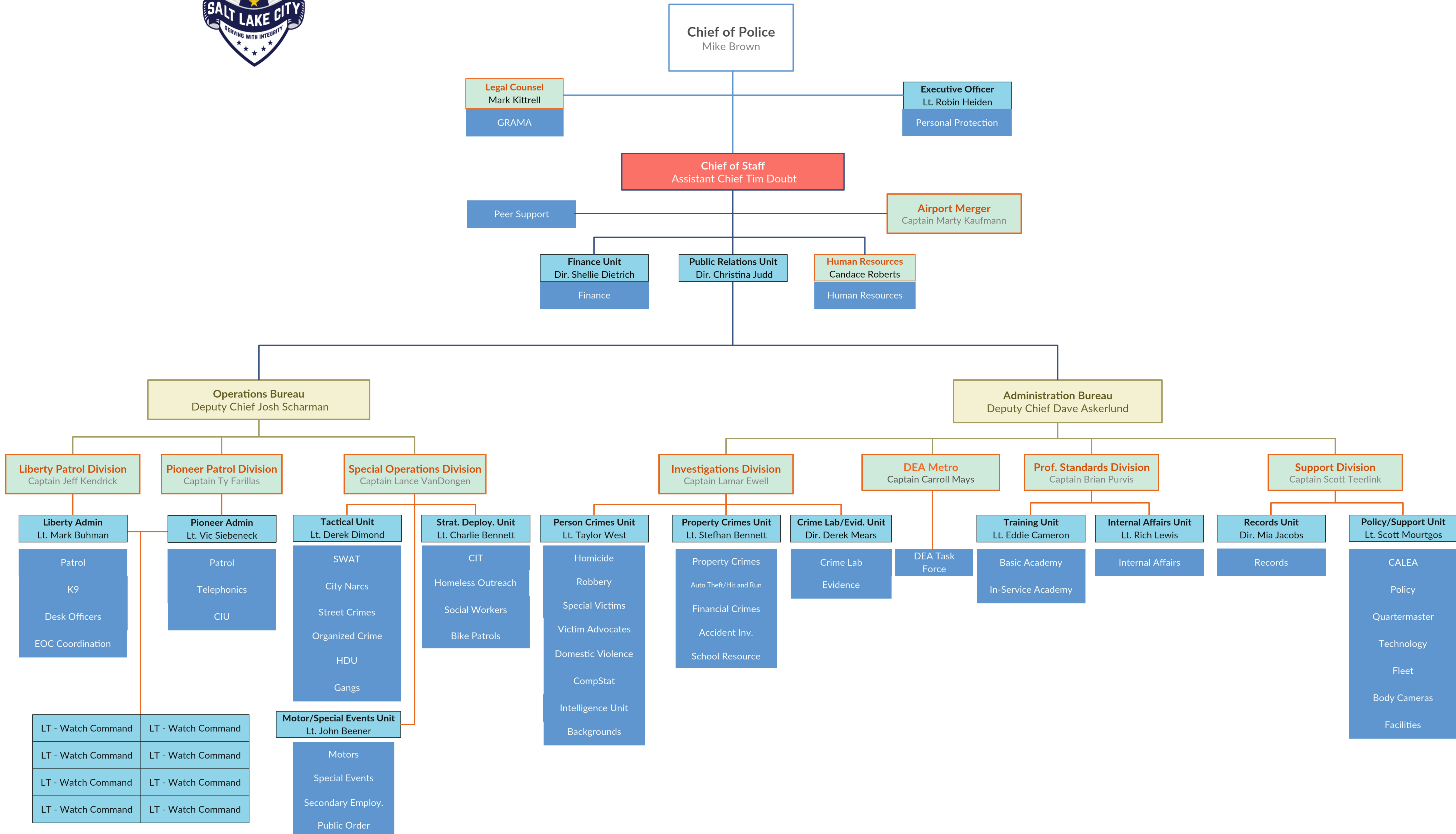

SLCPD Consent to Search Form.pdf



Salt Lake City Police Department Consent to Search Form

I, _____, have been informed that officer(s) of the Salt Lake City Police Department wish to search my:

Person Personal belongings in my possession

Vehicle: Make _____ Model _____ Year _____

Residence: located at _____

Including: outbuildings/sheds garage other _____

I have been informed that I have a constitutional right to deny consent to search and require that the officers obtain a search warrant prior to any search being conducted.

I have been informed that I have a right to stop the search at any time and require that the officers obtain a search warrant.

By signing below, I am providing written consent/permission for the above named officer (s), or his/their designee(s), to conduct the search without obtaining a warrant and seize any evidence outlined above. I give consent/permission freely and voluntarily without threats or promises of any kind, either express or implied, made to me or someone close to me to convince me to grant consent/permission to search the property described above.

Signature of person providing consent

Signature of witnessing Officer IBM

Date: _____

Time: _____

Location: _____

Rights explained by: _____

Print Name

IBM

Was consent refused? Y / N If so, by whom: _____

SLCPD Consent to Search Form - Fillable.pdf



Salt Lake City Police Department Consent to Search Form

I, _____, have been informed that officer(s) of the Salt Lake City Police Department wish to search my:

Person Personal belongings in my possession

Vehicle: Make _____ Model _____ Year _____

Residence: located at _____

Including: outbuildings/sheds garage other _____

I have been informed that I have a constitutional right to deny consent to search and require that the officers obtain a search warrant prior to any search being conducted.

I have been informed that I have a right to stop the search at any time and require that the officers obtain a search warrant.

By signing below, I am providing written consent/permission for the above named officer (s), or his/their designee(s), to conduct the search without obtaining a warrant and seize any evidence outlined above. I give consent/permission freely and voluntarily without threats or promises of any kind, either express or implied, made to me or someone close to me to convince me to grant consent/permission to search the property described above.

Signature of person providing consent

Signature of witnessing Officer IBM

Date: _____

Time: _____

Location: _____

Rights explained by: _____

Print Name

IBM

Was consent refused? Y / N If so, by whom: _____

**SIGNIFICANT EXPOSURE FLOW
CHART FOR SUPERVISORS.pdf**

SIGNIFICANT EXPOSURE FLOW CHART FOR SUPERVISORS (SLCPD POLICY 1018)

OFFICER SUFFERS SIGNIFICANT EXPOSURE

OFFICER SHOULD BEGIN DE-CONTAMINATION PROCEDURES IMMEDIATELY

OFFICER GOES DIRECTLY TO **UMED ED** AND CHECKS IN. OFFICER NEEDS TO FILL OUT FORM 350 (POLICY MANUAL OR P:/drives/forms/form 350) AND GIVE THIS TO HOSPITAL STAFF

COUNSEL THE EMPLOYEE THAT **THEY DO NOT HAVE TO HAVE THEIR BLOOD DRAWN THE DAY OF OR THE DAY AFTER THE INCIDENT** TO GET A 'BASELINE' READING (used by medical staff to determine what, if any, preexisting communicable diseases the employee has).

ASK FOR CONSENT TO DRAW BLOOD FROM SOURCE PATIENT

SOURCE GIVES CONSENT: DOCUMENT CONSENT ON FORM 350

WARRANT IS APPROVED

SOURCE DENIES CONSENT: WRITE WARRANT FOR SOURCE PATIENT BLOOD – UCA 78B-8-402

WARRANT IS DENIED – DOCUMENT CONTACT INFORMATION FOR FOLLOWUP BY CITY PROSECUTOR'S OFFICE

IF SOURCE PATIENT NEEDS MEDICAL CARE: TRANSPORT TO UMED. STAFF AT UMED CAN DRAW THE NEEDED BLOOD.

IF SOURCE PATIENT DOES NOT NEED MEDICAL CARE OR IS TRANSPORTED TO ANY OTHER MEDICAL FACILITY: CALL OUT PHLEBOTOMIST. ENSURE PHLEBOTOMIST COLLECTS 2 **YELLOW TOP** BLOOD VIALS. THE PHLEBOTOMIST MUST THEN TRANSPORT THE BLOOD, ALONG WITH FORM 350, SEARCH WARRANT, AND ANY OTHER PAPERWORK, TO **UMED**

SUPERVISOR MUST INVESTIGATE AND DOCUMENT THE FOLLOWING:

1. Name of the member exposed
2. DATE AND TIME OF INCIDENT
3. LOCATION OF INCIDENT
4. Potentially infectious materials involved and the source of the exposure (the source patients ID)
5. WORK BEING DONE DURING EXPOSURE
6. HOW THE INCIDENT OCCURRED OR WAS CAUSED
7. PPE IN USE AT THE TIME OF THE INCIDENT
8. ACTIONS TAKEN POST-EVENT (E.G. CLEAN-UP, NOTIFICATIONS)

FORWARD ALL APPLICABLE DOCUMENTS TO ECO (Pioneer Patrol Division XO)

EXPOSED EMPLOYEE MUST:

-NOTIFY CORVEL

EXPOSED EMPLOYEE SHOULD:

-KEEP A COPY OF FORM 350 FOR THEIR OWN RECORDS

Significant Eposure Flow Chart.pdf

SIGNIFICANT EXPOSURE FLOW CHART FOR SUPERVISORS (SLCPD POLICY 1018)

OFFICER SUFFERS SIGNIFICANT EXPOSURE

OFFICER SHOULD BEGIN DE-CONTAMINATION PROCEDURES IMMEDIATELY

OFFICER GOES DIRECTLY TO **UMED ER** AND CHECKS IN. OFFICER NEEDS TO FILL OUT FORM 350 (POLICY MANUAL OR P:/drives/forms/form 350) AND GIVE THIS TO HOSPITAL STAFF

COUNSEL THE EMPLOYEE THAT **THEY DO NOT HAVE TO HAVE THEIR BLOOD DRAWN THE DAY OF OR THE DAY AFTER THE INCIDENT** TO GET A 'BASELINE' READING (used by medical staff to determine what, if any, preexisting communicable diseases the employee has).

ASK FOR CONSENT TO DRAW BLOOD FROM SOURCE PATIENT

SOURCE GIVES CONSENT: DOCUMENT CONSENT ON FORM 350

WARRANT IS APPROVED

SOURCE DENIES CONSENT: WRITE WARRANT FOR SOURCE PATIENT BLOOD – UCA 78B-8-402

WARRANT IS DENIED – DOCUMENT CONTACT INFORMATION FOR FOLLOWUP BY CITY PROSECUTOR'S OFFICE

IF SOURCE PATIENT NEEDS MEDICAL CARE: TRANSPORT TO UMED. STAFF AT UMED CAN DRAW THE NEEDED BLOOD.

IF SOURCE PATIENT DOES NOT NEED MEDICAL CARE OR IS TRANSPORTED TO ANY OTHER MEDICAL FACILITY: CALL OUT PHLEBOTOMIST. ENSURE PHLEBOTOMIST COLLECTS 2 **YELLOW TOP** BLOOD VIALS. THE PHLEBOTOMIST MUST THEN TRANSPORT THE BLOOD, ALONG WITH FORM 350, SEARCH WARRANT, AND ANY OTHER PAPERWORK, TO **UMED**

SUPERVISOR MUST INVESTIGATE AND DOCUMENT THE FOLLOWING:

1. Name of the member exposed
2. DATE AND TIME OF INCIDENT
3. LOCATION OF INCIDENT
4. Potentially infectious materials involved and the source of the exposure (the source patients ID)
5. WORK BEING DONE DURING EXPOSURE
6. HOW THE INCIDENT OCCURRED OR WAS CAUSED
7. PPE IN USE AT THE TIME OF THE INCIDENT
8. ACTIONS TAKEN POST-EVENT (E.G. CLEAN-UP, NOTIFICATIONS)

FORWARD ALL APPLICABLE DOCUMENTS TO ECO (Pioneer Patrol Division XO)

EXPOSED EMPLOYEE MUST:

-NOTIFY CORVEL

EXPOSED EMPLOYEE SHOULD:

-KEEP A COPY OF FORM 350 FOR THEIR OWN RECORDS

Consent to Release Video Form - Internal.pdf



P.O. Box 145550, Salt Lake City, UT 84114
Ph: 801-575-2401 Fax: 801-575-2407

SALT LAKE CITY INTERNATIONAL AIRPORT CONSENT TO RELEASE SECURITY CAMERA VIDEO RECORDING - INTERNAL

This video is being requested and provided for the sole purpose of City-related business. As this footage may contain sensitive information, it must be viewed and stored in a secure location. Additionally, it must be protected and held confidential in accordance with GRAMA. Further copying or distribution of this footage is strictly prohibited. Any requests for copies of this footage should be directed to the GRAMA Coordinator.

SECTION 1 – REQUESTING PARTY		
Last Name:	First Name:	Middle Name:
Airport Division/City Department:		Supervisor:
Email Address:	Phone Number:	Date:
SECTION 2 – SECURITY CAMERA VIDEO RECORDING (Requested Video)		
Event Date:		
Event Time:		
Event Location:		
Camera Number:		
Purpose of Request:		
SECTION 3 – APPROVED BY (DIVISION HEAD OR DESIGNEE)		
Name:	Signature:	Date:
SECTION 4 – VIDEO RECEIVED BY		
Name:	Signature	Date:
SECTION 5 – RELEASED BY		
Name:	Signature:	Date:
Copy to: <input type="checkbox"/> Operations <input type="checkbox"/> Legal		Form Reference No. _____

**Salt Lake City Police Department
Organizational Chart v2.15 2020-08-17.pdf**

SALT LAKE CITY POLICE DEPARTMENT ORGANIZATIONAL CHART

Executive Assistant to the Chief Laura Nygaard GRAMA Coordinator Candee Allred; Police Legal Advisor Mark Kittrell				CHIEF OF POLICE Mike Brown				Lieutenant, Executive Officer Vic Siebeneck ■ Community Outreach Unit Mgr. Dustin Parks ■ Executive Protection Unit							
Director, Finance & Administrative Services Shellie Dietrich				ASSISTANT CHIEF / CHIEF OF STAFF Tim Doubt				Director, Communications & Media Relations Christina Judd ■ Sergeant, Communications & Media Relations Keith Horrocks							
DEPUTY CHIEF, ADMINISTRATION BUREAU LaMar Ewell				DEPUTY CHIEF, OPERATIONS BUREAU Jeff Kendrick											
Captain, DEA Task Force Carroll Mays		Captain, Investigations Brian Purvis		Captain, Prof. Standards Scott Teerlink		Captain, Support Division Mark Buhman*		Captain, Airport Division Stefhan Bennett		Captain, Liberty Division Rich Lewis		Captain, Pioneer Division John Beener		Captain, Central Division Lance VanDongen	
Lieutenant, Property Crime Scott Smalley		Lieutenant, Persons Crime Scott Mourtgos		Lieutenant, Internal Affairs Charli Goodman		Lieutenant, Support Mark Cryder		Lieutenant, Administration Mark Bretzing		Lieutenant, Administration Gary Trost		Lieutenant, Administration Vacant		Lieutenant, Administration Andy Leonard	
■ Sergeant, Accident Inv. Tom Potter		■ Sergeant, Domestic Violence Dan Davis		■ Sergeant, Prof. Standards† Mason Givens		■ Coordinators, Logistics Unit Jeff Carter (Fleet) Alan Dawes (Technology) Andy Kupka (Comms)		■ Sergeant, Airport K9 Unit Brandon Shearer		■ Sergeant, East Bike Unit Steve Wooldridge		■ Sergeant, West Bike Unit Sean Werner		■ Sergeant, Central Bike Unit Harrison Livsey	
■ Sergeant, Airport Inv. Ryan Albrecht		■ Sergeant, Homicide Unit Derek Christensen		■ Sergeant, Internal Affairs Tyler Lowe		■ Sergeant, Quartermaster Cody Lougy		■ Sergeant, Administration Dave Bywater		■ Sergeant, City K9 Unit Cale Lennberg		■ Sergeant, Gang Unit Devin Stutz		■ Sergeant, Park Squad Gordon Worsencroft	
■ Sergeant, Auto Theft Unit Richelle Bradley		■ Sergeant, Robbery Unit Chris Johnson		■ Sergeant, Internal Affairs Jeff North		■ Sergeant, Training Unit Yvette Zayas		■ Sergeant, Duty Bruce Davies		■ Sergeant, CIU Allen Christensen		■ Field Training Officers		■ Community Connection Center Director Jessica Waters	
■ Sergeant, Financial Crimes Dale Bench		■ Sergeant, SLIC Dustin Marshall		■ Sergeant, Training Unit Russell Peterson		■ Director, Records Mia Jacobs		■ Sergeant, Duty Geno Garcia		■ Watch Command (D) Lt. Russ Amott		■ Watch Command (D) Lt. Brian Sloan		■ Sergeant, CIT/HOST Scott Stuck	
■ Sergeant, Property Crimes Josh Ashdown (East)		■ Sergeant, Special Victims Jared Gilbert		■ Supervisor, Records Teresa Gutierrez (Day)		■ Supervisor, Records Stephanie Hatch (Day)		■ Sergeant, Duty Phil Eslinger		■ Watch Command (D) Lt. Sam Wolf		■ Patrol Sergeant (D) Joe Cyr (SSM)		■ Lieutenant, Motor/Sp Event/POU Jenn Diederich	
■ Sergeant, Property Crimes Bret Richmond (West)		■ Supervisor, Victim Advocates Wendy Isom		■ Supervisor, Records Suzanne Sullivan (Afternoon)		■ Supervisor, Records Jeremy Lewis (Afternoon)		■ Lieutenant, Operations Todd Mitchell (Day)		■ Patrol Sergeant (D) Ben Hone (FSS)		■ Patrol Sergeant (D) Andrew Cluff (TFS)		■ Sergeant, Motors Unit Andy Jackson (D)	
■ Sergeant, School Resource Doug Teerlink		■ Director, Stats & Analysis Amberly Doubt		■ Supervisor, Records Casey Hedman (Graves)		■ Supervisor, Records Nick Schneider		■ Sergeant, Duty Nick Schneider		■ Patrol Sergeant (D) Lisa Pascadlo (SMT)		■ Patrol Sergeant (D) Jeremy Sayes (TWT)		■ Sergeant, Motors Unit Tom Wind (A)	
■ Child Abduction Response Team		■ Jacob Jackson (Sen Specialist) ■ Karen Kener (Sen Specialist)		■ Supervisor, Records Casey Hedman (Graves)		■ Lieutenant, Operations James Porter (Graves)		■ Sergeant, Duty Brent Baker		■ Patrol Sergeant (D) Richard Chipping (TWT)		■ Watch Command (A) Lt. Mike Hatch		■ Public Order Unit	
Director, Crime Lab/Evidence Derek Mears		Special Investigations Lt. Derek Diamond						■ Lieutenant, Operations James Porter (Graves)		■ Watch Command (A) Lt. Sam Wolf		■ Patrol Sergeant (A) Brandon Hansen (FSS)		■ Watch Command (D) Lt. Brett Olsen	
■ Supervisor, Crime Lab Julene Lundsberg		■ Sergeant, Narcotics Unit Josh Allred						■ Sergeant, Duty Angela Cooper		■ Patrol Sergeant (A) Christian Van Wagoner (SSM)		■ Patrol Sergeant (A) Kevin Blue (SMT)		■ Patrol Sergeant (D) Bron Cruz (SSM)	
■ Supervisor, Crime Lab Jeffery Moline		■ Sergeant, Organized Crime Leigh Willis						■ Sergeant, Duty Kacey Cowley		■ Patrol Sergeant (A) Nathan Groves (WTF)		■ Patrol Sergeant (A) Jaron Harker (TWT)		■ Patrol Sergeant (D) Brandee Downes (TWT)	
■ Supervisor, Evidence Haley Takoch		■ Sergeant, SWAT Bill Manzanares						■ Sergeant, Duty John Murdoch		■ Patrol Sergeant (A) Ryan Sanders (MTW)		■ Watch Command (G) Lt. Alma Sweeny		■ Patrol Sergeant (D) Kevin Stayner (TFS)	
		■ Sergeant, Hazardous Devices Unit Ryan Albrecht								■ Watch Command (G) Lt. Dave Cracroft		■ Patrol Sergeant (G) Tim Stumm (FSS)		■ Watch Command (A) Lt. Dave Wierman	
										■ Patrol Sergeant (G) Jacob Hatch (SSM)		■ Patrol Sergeant (G) Jacob McLelland (SMT)		■ Patrol Sergeant (A) Mark Schuman (TWT)	
										■ Patrol Sergeant (G) Rob Tycz (WTF)		■ Patrol Sergeant (G) Matt Cook (TWT)		■ Watch Command (G) Lt. Carlos Valencia	
										■ Patrol Sergeant (G) Tyrell Jeffries (MTW)				■ Patrol Sergeant (G) Bret Hatch (FSS)	
														■ Patrol Sergeant (G) Drew Hadley (SMT)	
														■ Patrol Sergeant (G) Kory Checketts* (TWT)	

August 17, 2020. Version 2.15. Chiefs, captains, lieutenants, sergeants, directors, managers, supervisors, coordinators, bureaus, divisions, units; groups and collateral units (blue text). Lieutenants and Directors report directly to their assigned Captains.

† The Sergeant, Professional Standards is the Policy Custodian and supervises the Accreditation Unit, the Audit & Inspection Unit and the Background Investigations Unit. * Denotes acting or temporary capacity.

SLCPD Consent to Search Form - Fillable.pdf



Salt Lake City Police Department Consent to Search Form

I, _____, have been informed that officer(s) of the Salt Lake City Police Department wish to search my:

Person Personal belongings in my possession

Vehicle: Make _____ Model _____ Year _____

Residence: located at _____

Including: outbuildings/sheds garage other _____

I have been informed that I have a constitutional right to deny consent to search and require that the officers obtain a search warrant prior to any search being conducted.

I have been informed that I have a right to stop the search at any time and require that the officers obtain a search warrant.

By signing below, I am providing written consent/permission for the above named officer (s), or his/their designee(s), to conduct the search without obtaining a warrant and seize any evidence outlined above. I give consent/permission freely and voluntarily without threats or promises of any kind, either express or implied, made to me or someone close to me to convince me to grant consent/permission to search the property described above.

Signature of person providing consent

Signature of witnessing Officer IBM

Date: _____

Time: _____

Location: _____

Rights explained by: _____

Print Name

IBM

Was consent refused? Y / N If so, by whom: _____

Mothers Room Key Form.pdf

**Accident Flow Chart Involving
Department Employees.pdf**

Fatal & Probable Fatal Crashes

Watch Commander/Sergeant Notified

- ✓ Respond to the Scene
- ✓ Initiate Initial Investigation (DI-9)
- ✓ Start Scene Security & Major Incident Log
- ✓ Crime Lab Photographs
- ✓ Witnesses IDed & Retained (Statements Completed)
- ✓ Officers on-scene Check Sobriety
- ✓ Condition Verified

Verified Alpha, Bravo, OR Charlie

Verified Delta OR Echo (in-person @ Hospital)

*On A & B injuries photos can be taken by Officer with an adequate phone camera

Call for Barricades

Initial Officer Completes DI-9

Call the Property Crimes Lieutenant OR Unified Dispatch (801-743-3000) for "CAR" Response (NOT CART)

Patrol Diagrams Scene (on Charlie condition accidents)

DI-9 Completed by Initial Officer
CAR assumes Investigation

Hospitals DO NOT USE alphanumeric codes

Critical Unstable IS considered Delta

Conscious, Breathing, & Alert is NOT considered Delta by PD

Officer Involved Crash

Level 2 Crash

A level 2 collision occurs when a Department employee operating a vehicle owned or leased by the City collides with a fixed object or other City-owned/leased vehicle or property resulting in minor (non-reportable) damage to only the City-owned/leased vehicle or property.

Collision Occurs

Watch Commander/Sergeant Notified

Involved Officer Completes Employee Accident Report Form

Photos Taken of Damage (This can be done with an adequate phone camera)

- ✓ Directly entered into Blue Team (within 12 hours of occurrence) by handling Supervisor within same Division
- ✓ Photos & Employee Accident Report Form attached to Blue Team
 - DI-9 is NOT necessary
- ❖ A G.O. Report is ONLY necessary IF Crime Lab is called for photos

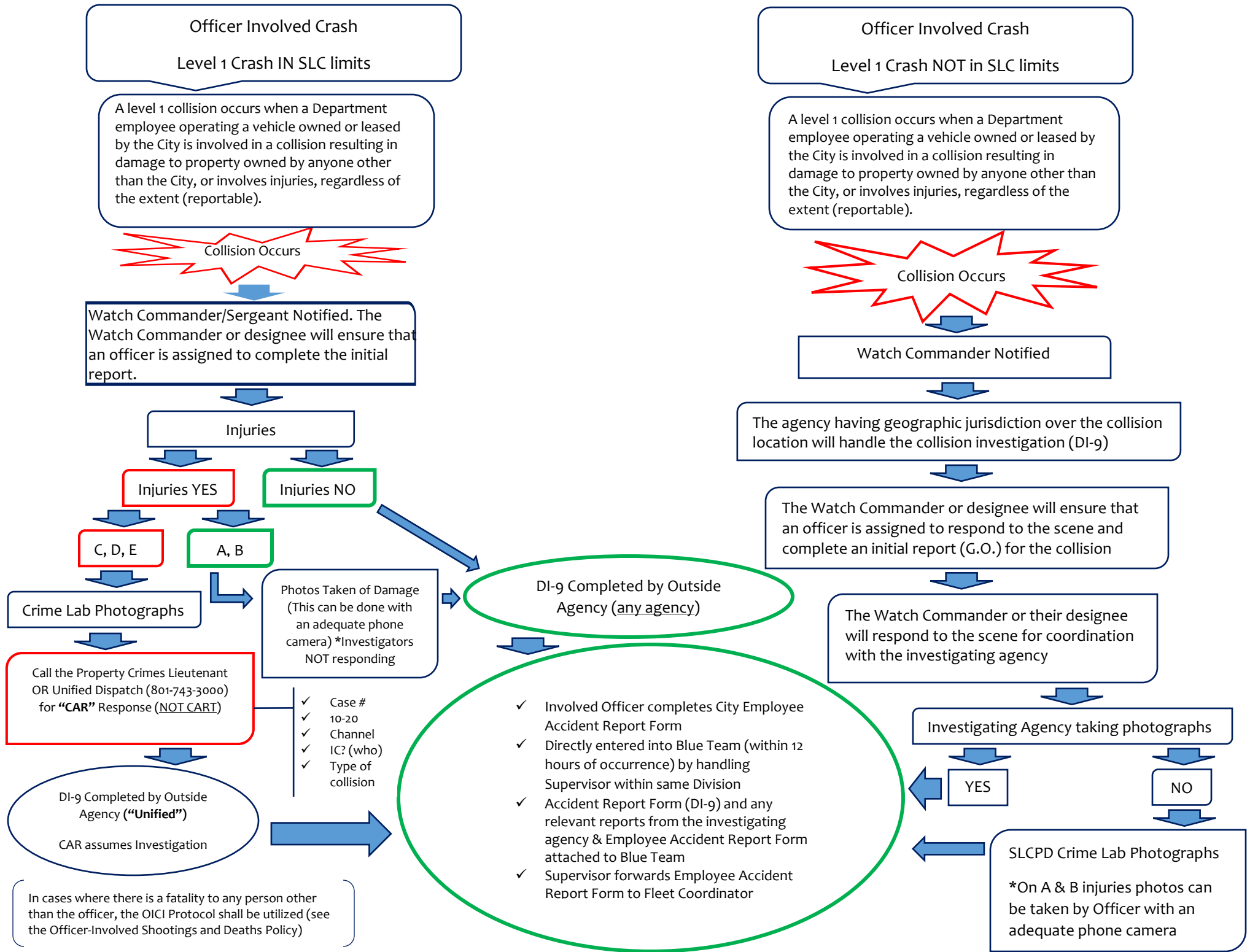

In cases where there is a fatality to any person other than the officer, the OICI Protocol shall be utilized (see the Officer-Involved Shootings and Deaths Policy)

- ✓ Case #
- ✓ 10-20
- ✓ Channel
- ✓ IC? (who)
- ✓ Type of collision

- ✓ Involved Officer completes City Employee Accident Report Form
- ✓ Directly entered into Blue Team (within 12 hours of occurrence) by handling Supervisor within same Division
- ✓ Accident Report Form (DI-9) and any relevant reports from the investigating agency & Employee Accident Report Form attached to Blue Team
- ✓ Supervisor forwards Employee Accident Report Form to Fleet Coordinator

SLCPD Crime Lab Photographs
*On A & B injuries photos can be taken by Officer with an adequate phone camera

SLCPD Mothers Room Key Form.pdf



SALT LAKE CITY POLICE DEPARTMENT
MOTHER'S ROOM KEY

On _____, I received a key to the Mother's Room,

located in the Public Safety Building or Pioneer Precinct. I agree to return this key

to the Quartermaster when I no longer need access to this room for the duration of

_____ to _____.

EMPLOYEE NAME

EMPLOYEE'S SIGNATURE



SALT LAKE CITY POLICE DEPARTMENT
MOTHER'S ROOM KEY

On _____, I received a key to the Mother's Room,

located in the Public Safety Building or Pioneer Precinct. I agree to return this key

to the Quartermaster when I no longer need access to this room for the duration of

_____ to _____.

EMPLOYEE NAME

EMPLOYEE'S SIGNATURE

Military Extended Leave Form.pdf

MILITARY EXTENDED LEAVE FORM

Members Name:

Employee ID#:

Method to maintain communication (email address or phone number):

Date Deployed:

Expected Return Date to PD:

Members called to Military Duty:

Per policy 1029.5.1 members activated to military duty for a period longer than 180 days are required to meet with the Office of the Chief for an exit interview (out-processing) with the Chief of Police or designee. The member may choose a point of contact for the Department, and the member will coordinate with the Quartermaster and the Department Fleet Coordinator to facilitate equipment storage. The member will also meet with the Human Resources Consultant to coordinate leave/benefit items.

- | | | |
|--|-----|----|
| • Quartermaster | Yes | No |
| • Fleet Coordinator | Yes | No |
| • Meeting with Human Resources Consultant to coordinate leave/benefits | Yes | No |

Out-Processing interview completed by:

Date:

Once this form is completed, the Division Commander (or designee) of the member's Division must forward the form to the member's City personnel file.

Date form was forwarded to City personnel file:

Forwarding Supervisor:

Military Extended Leave Reintegration Form.pdf

MILITARY EXTENDED LEAVE REINTEGRATION FORM

Members Name:

Employee ID#:

Date Deployed:

Date Actually Returned to PD:

Members returning from Extended Absence:

Per policy 1029.5.2 any member returning from military duty for a period longer than 180 days will meet with the Office of the Chief and Training Unit to facilitate in-processing. This includes an interview with the Chief of Police or designee.

- | | | |
|--|-----|----|
| • Return of any agency stored equipment to the member | Yes | No |
| • Initial and/or refresher training | Yes | No |
| • Weapons requalification | Yes | No |
| • Meeting with Human Resources Consultant to coordinate leave/benefits | Yes | No |

In-Processing interview completed by:

Date:

Once this form is completed, the Division Commander (or designee) of the member's Division must forward the form to the member's City personnel file.

Date form was forwarded to City personnel file:

Forwarding Supervisor:

Investigative Photography by Officers.pdf

PHOTOGRAPHY FOR POLICE OFFICERS

POLICY: INVESTIGATIVE PHOTOGRAPHING BY OFFICERS

- DOMESTIC VIOLENCE INVESTIGATIONS THAT DO NOT INVOLVE INJURIES (I.E. PROPERTY DAMAGE ONLY)
- VANDALISMS NOT AMOUNTING TO A FELONY
- DAMAGE TO CITY PROPERTY – THIS INCLUDES CATEGORY 2 OFFICER-INVOLVED TRAFFIC ACCIDENTS (COLLISION WITH OTHER CITY PROPERTY/VEHICLES)
- TRAFFIC COLLISIONS WHERE ACCIDENT INVESTIGATORS ARE NOT RESPONDING – THIS INCLUDES COLLISIONS WITH ALPHA AND/OR BRAVO INJURIES
- TRAFFIC COLLISIONS INVOLVING UTA VEHICLES (TRAX AND BUS) NOT REQUIRING ACCIDENT INVESTIGATORS – THIS INCLUDES COLLISIONS WITH ALPHA AND/OR BRAVO INJURIES

POLICY: INVESTIGATIVE PHOTOGRAPHING BY OFFICERS, CONT.

- THEFTS AND RETAIL THEFTS
- SIMPLE POSSESSION CASES (E.G. DRUGS, PARAPHERNALIA, FINANCIAL DOCUMENTS, ID'S, ETC.)
- STOLEN VEHICLES
- OTHER TYPES OF INVESTIGATIONS NOT REQUIRING CRIME LAB PROCESSING, MEASUREMENTS, OR OTHER FORENSIC ANALYSIS

POLICY: INVESTIGATIVE PHOTOGRAPHING BY OFFICERS CONT.

CRIME LAB SHOULD BE CALLED IF PROCESSING, MEASUREMENTS, OR OTHER FORENSIC ANALYSIS IS NEEDED, SUCH AS TRAFFIC COLLISIONS INVOLVING CHARLIE OR WORSE INJURIES, HIT AND RUN INVESTIGATIONS, ANY DOMESTIC VIOLENCE OR ASSAULT INVESTIGATIONS INVOLVING INJURIES, AND DEATH SCENES.

* IF UNABLE TO CAPTURE DESIRED PHOTOGRAPHS DUE TO CONDITIONS, CRIME LAB SHOULD BE CALLED.

AXON CAPTURE APPLICATION



saltlakecitypd.evidence.com

AXON CAPTURE APPLICATION, CONT.

The app allows you to take photos, audio recordings, videos within the app and does not save it to the phone.

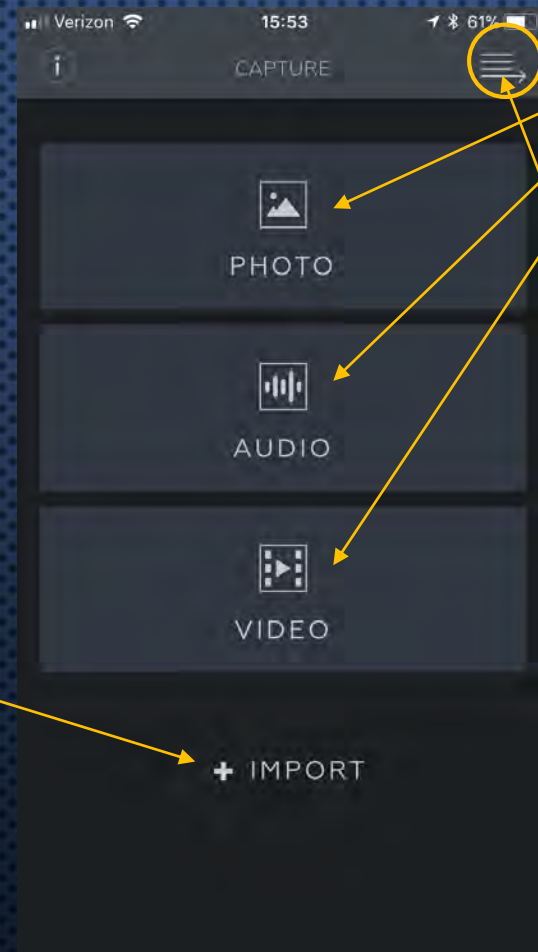

Click on the desired capture function.

This button will take you to the EVIDENCE LIST

If photographs were taken using the cell phone camera app use the + IMPORT button to transfer the photos.

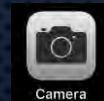

AXON CAPTURE APPLICATION, CONT.

These two buttons will send you back to the CAPTURE page.

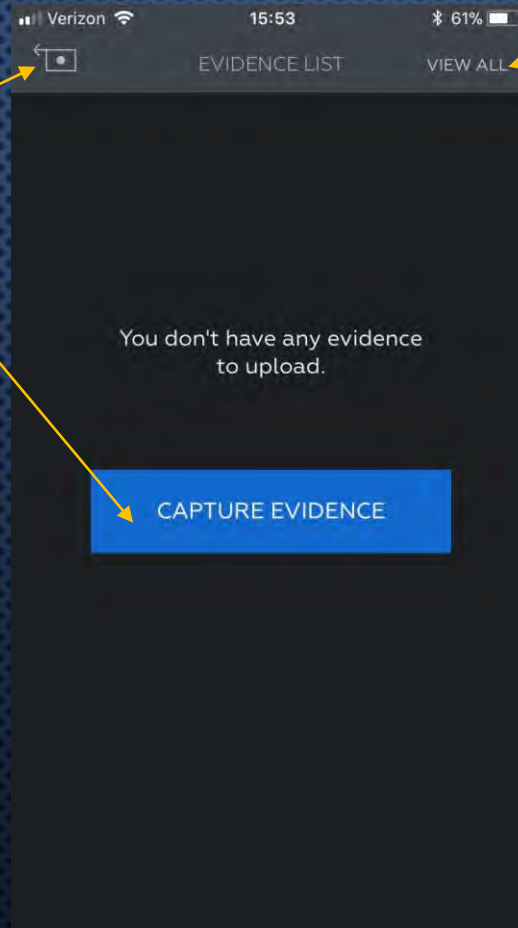

Selecting VIEW ALL will give you options to select only desired media files

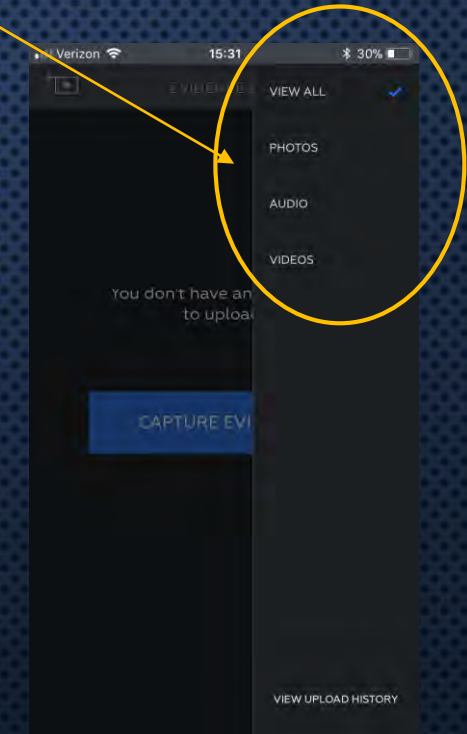

AXON CAPTURE APPLICATION, CONT.

Horizontal

Vertical

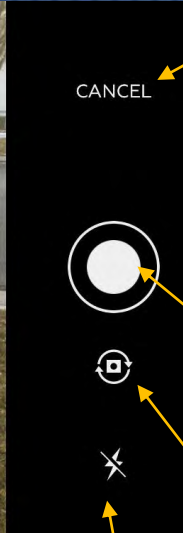

Returns to Capture Screen

Button to Take Picture

Change Camera Source. Front/Back



Flash OFF Flash ON Flash AUTO

Flash
Click on Flash for Options

AXON CAPTURE APPLICATION, CONT.

Number of Pictures taken



When finished with the series of photos for the case, click on the mountain icon with the BLUE circle containing the number of photos taken.

AXON CAPTURE APPLICATION, CONT.

Enter case number
(ex: 17-1234567)

of files with this case

ALWAYS SELECT
CRIME LAB EVIDENCE
@ BOTTOM OF CATEGORIES!

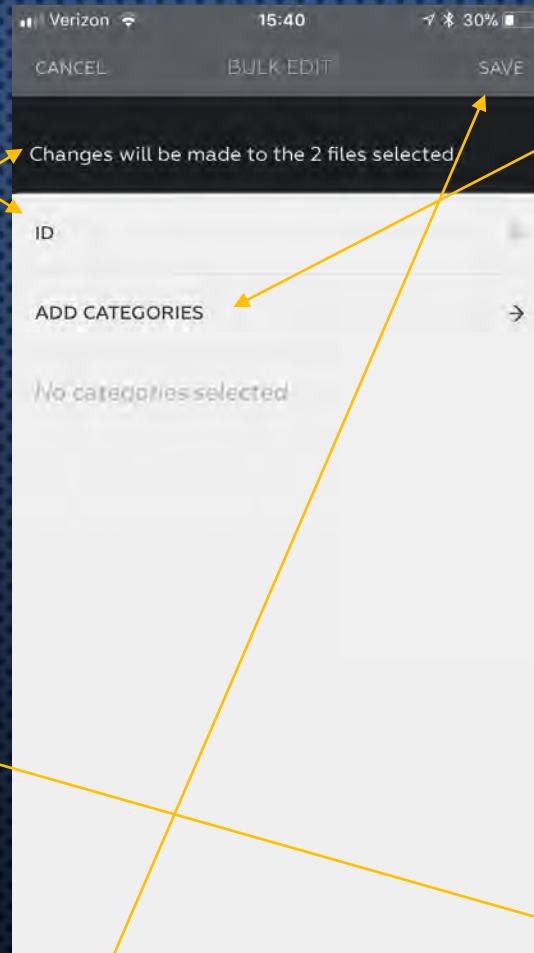

SAVE after entries ID &
Categories selected.

ADD CATEGORIES



select
from the
following

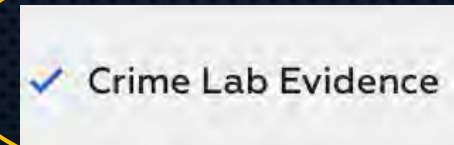

AXON CAPTURE UPLOAD

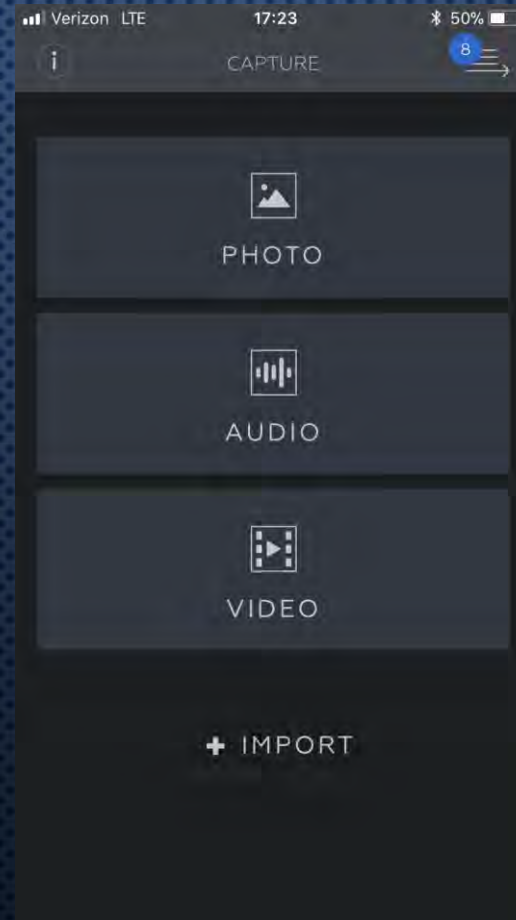

To UPLOAD the Photographs, Audio and Video push here

AXON CAPTURE UPLOAD

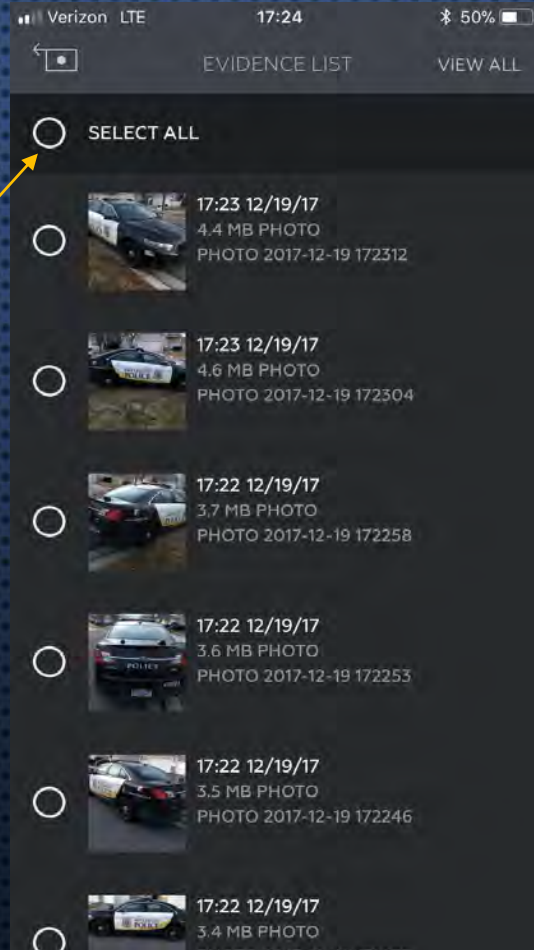

Press 'Select All' if all the photos taken have been given an ID (case #) and the Crime Lab Evidence Category has been selected.

AXON CAPTURE UPLOAD

Upload: to submit the evidence to Evidence.com

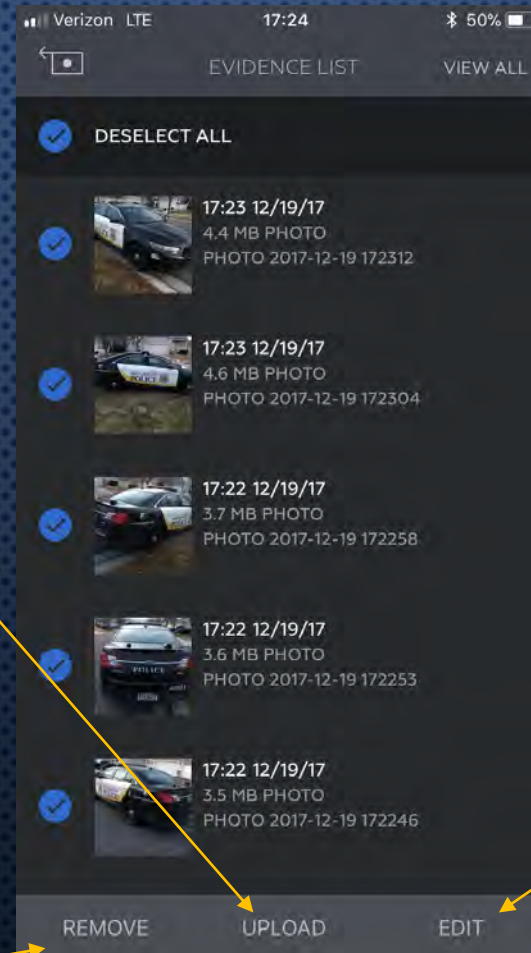

Edit: to ADD ID # or ADD/Change Categories

Remove: to delete evidence

AXON CAPTURE UPLOAD

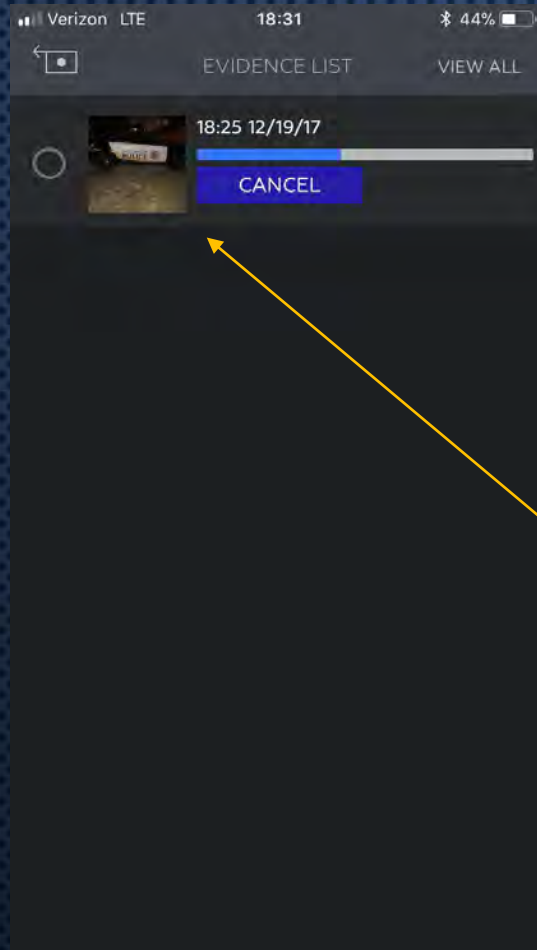

The Evidence will automatically UPLOAD as long as the app is opened in the background.

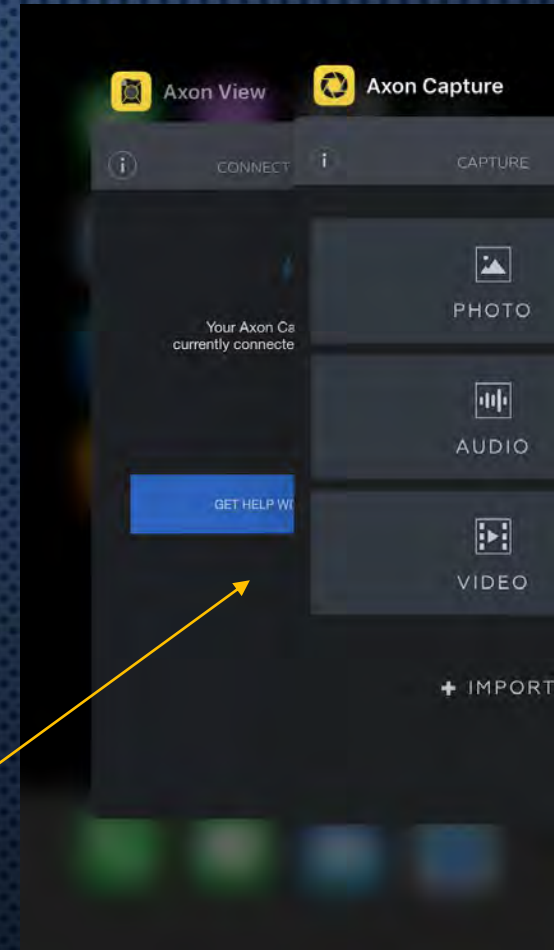

Axon View & Axon Capture opened in the background.

HOW TO PHOTOGRAPH

1. OVERALL – SHOW THE GENERAL LOCATION
2. MID-RANGE – SHOW THE RELATIONSHIP TO SURROUNDINGS
3. CLOSE-UP – SHOW DETAIL

HOW TO PHOTOGRAPH

OVERALL



WHERE ARE WE?

RELATIONSHIP TO
SURROUNDING OBJECTS

MID-RANGE



CLOSE-UP



PHOTOGRAPHING TRAFFIC ACCIDENTS

- OVERALL SCENE PHOTOGRAPHS
- DEBRIS/GLASS/TIRE MARKS
- OVERALL VEHICLE PHOTOGRAPHS (8 POINTS)
- MID-RANGE AND CLOSE-UP OF DAMAGE

PHOTOGRAPHING TRAFFIC ACCIDENTS, CONT.

OVERALL SCENE PHOTOGRAPHS

Pan over scene from side to side for orientation purposes

Include landmarks-
Where are we?



PHOTOGRAPHING TRAFFIC ACCIDENTS, CONT.

OVERALL SCENE PHOTOGRAPHS

90 degrees to street lines, vehicles, and landmarks



PHOTOGRAPHING TRAFFIC ACCIDENTS, CONT.

OVERALL SCENE PHOTOGRAPHS

90 degrees to street lines, vehicles, and landmarks



PHOTOGRAPHING TRAFFIC ACCIDENTS, CONT.

DEBRIS, GLASS & TIRE MARKS

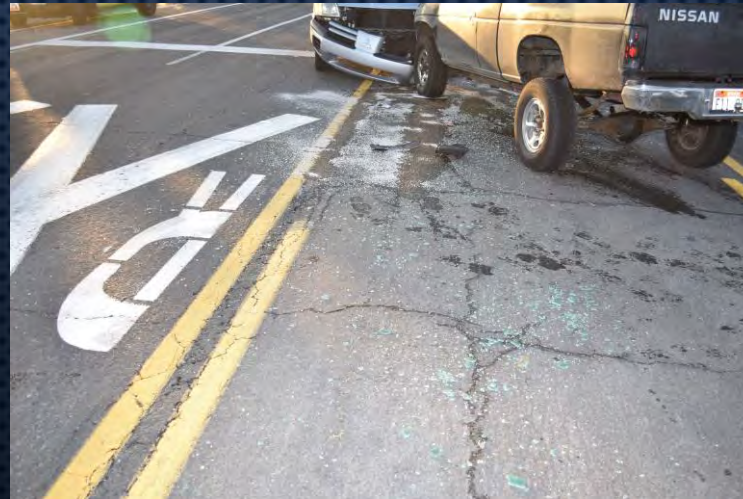

PHOTOGRAPHING TRAFFIC ACCIDENTS, CONT.

DEBRIS, GLASS & TIRE MARKS

Photograph the beginning of tire marks – crucial evidence



Photograph end of tire marks – crucial evidence



PHOTOGRAPHING TRAFFIC ACCIDENTS, CONT.

OVERALL VEHICLE PHOTOGRAPHS: 8 Points

Rear



Rear Corner



Side



Front Corner



PHOTOGRAPHING TRAFFIC ACCIDENTS, CONT.

OVERALL VEHICLE PHOTOGRAPHS: 8 Points

Front



Other Front Corner



Other Side



Other Rear Corner



PHOTOGRAPHING TRAFFIC ACCIDENTS, CONT.

MIDRANGE AND CLOSE-UP OF DAMAGE

MID-RANGE

Orient damage to areas of the vehicle (grill, license plate, etc.)

CLOSE-UP



PRESENTATION CREATED BY:

- CRIME SCENE TECHNICIAN ARGUELLO: HOLLY.ARGUELLO@SLCGOV.COM; x3171
- DT. KNAUB: DAVID.KNAUB@SLCGOV.COM; x3670

**Salt Lake City Corporation Disclosure Statement
of Non-City Employment Business Interests.pdf**

**SALT LAKE CITY CORPORATION
DISCLOSURE STATEMENT OF
NON-CITY EMPLOYMENT/BUSINESS INTERESTS**

Salt Lake City Code Sections 2.44.050 and 2.44.060 require you to disclose **outside employment** and **outside business interests**, and prohibit you from holding outside employment that is incompatible with your City duties. For more information, please refer to those sections on the City's Internet site: www.slcgov.com.

This statement must be filed by all employees, elected officials, and volunteer members of regular or special committees, boards, authorities, agencies and commissions of the City. **After you file, if your position in a business entity changes, or the value of your interest in a business entity materially increases, you must file a new disclosure statement in January of the next year.** For purposes of the questions below, a "business entity" is a sole proprietorship (such as a consulting business or ownership of real estate held for rental or other business purposes), partnership, association, joint venture, corporation, limited liability company, firm, trust, foundation, or other organization or entity used in carrying on a business. You may answer "No" to any question below if the value of your interest is **\$2,000 or less**.

I, _____, certify that I hold the position of _____ with Salt Lake City Corporation, in the Department of _____, and that the following information is true and correct to the best of my knowledge:

1. Are you currently employed by any business entity other than Salt Lake City Corporation?	<input type="checkbox"/> Yes	<input type="checkbox"/> No
2. Are you currently an officer, director, agent, owner or employer of any business entity?	<input type="checkbox"/> Yes	<input type="checkbox"/> No
3. Do you, your spouse, or your minor children, in combination, own at least ten percent (10%) of the outstanding shares of stock in any corporation?	<input type="checkbox"/> Yes	<input type="checkbox"/> No
4. Do you, your spouse, or your minor children, in combination, have a ten percent (10%) or greater ownership interest in any limited partnership or other business entity?	<input type="checkbox"/> Yes	<input type="checkbox"/> No
5. If you answered "Yes" to question 1, 2, 3, or 4, is the business entity required to have a regulatory license issued by Salt Lake City Corporation?	<input type="checkbox"/> Yes	<input type="checkbox"/> No
6. Do you, your spouse, or your minor children have any sole proprietorships, such as a consulting business or ownership of real estate held for rental or any other business purpose?	<input type="checkbox"/> Yes	<input type="checkbox"/> No
7. If you answered "Yes" to any of the above questions, please provide the following information for each business interest:		
(a) The name of the business entity:		
(b) The address of the business entity:		
(c) The principal activity engaged in by the business entity:		
(d) The nature of your position or the interest held in the business entity:		
(e) Is the value of the interest in the business entity \$15,000 or more?	<input type="checkbox"/> Yes	<input type="checkbox"/> No

Attach additional sheets if necessary

I swear that the information provided by me in this disclosure statement is true and that all of my outside employment and outside business interests have been disclosed in writing on this statement.

DATED this _____ day of _____, _____ Signature _____

The foregoing instrument was acknowledged before me this _____ day of _____, _____ by _____	_____ NOTARY PUBLIC, residing in Salt Lake County, Utah My Commission Expires: _____
---	---

This is a financial disclosure statement only. Additional disclosures or restrictions may apply if your financial, business or professional activities conflict with your City responsibilities.

Health Records Authorization.pdf

UTAH AUTHORIZATION TO DISCLOSE HEALTH RECORDS TO A LAW ENFORCEMENT AGENCY

(For Law Enforcement Use Only. Deliver in person, or if mailed/faxed, with cover letter on agency letterhead. Complete all sections.)

1. I authorize the health care provider(s) listed below to disclose protected health records of:

Name of Patient *(print)* _____ Date of Birth _____
 Phone Number (____) _____ Soc. Sec.# *(optional)* _____
 Address _____
 City _____ State _____ Zip _____

2. Record(s) Requested from: Complete record(s) consisting of: Between the dates of:

A. (i) <i>(Physician/Facility Name and Location)</i> _____ _____	A. (ii) <i>(Check all that apply)</i> <input checked="" type="checkbox"/> Inpatient record <input checked="" type="checkbox"/> Outpatient record <input checked="" type="checkbox"/> Emergency record <input checked="" type="checkbox"/> Ambulance/transport record <input type="checkbox"/> Other	A. (iii) _____ to <u>discharge</u> today's date
B. (i) <i>(Physician/Facility Name and Location)</i> _____ _____	B. (ii) <i>(Check all that apply)</i> <input checked="" type="checkbox"/> Inpatient record <input checked="" type="checkbox"/> Outpatient record <input checked="" type="checkbox"/> Emergency record <input checked="" type="checkbox"/> Ambulance/transport record <input type="checkbox"/> Other	B. (iii) _____ to <u>discharge</u> today's date

C. I authorize my complete substance abuse treatment records to be disclosed from the following provider(s):
 (i) _____ NOT APPLICABLE _____ from the dates of: (ii) _____ to _____.
(Physician/Facility Name and Location)

I understand, by initialing this box, that I am allowing the disclosure to law enforcement of my substance abuse treatment records protected by Federal confidentiality rules (42 CFR part 2), and which are prohibited from redisclosure without my written consent (or otherwise permitted by these rules). Records given to law enforcement by this disclosure cannot be used to investigate or prosecute me for a criminal offense unless ordered by a court.

Patient initials:

(If the records requested are a minor's, both the minor and the parent must sign and initial this form.)

3. Provide these records to the following Law Enforcement Agency: (Agency name, address, phone):

SALT LAKE CITY POLICE DEPARTMENT 801-799-3000
 475 S. 300 E.
 PO BOX 145497
 SALT LAKE CITY, UTAH 84114-5497

4. Unless revoked (see 5. B below) this authorization will remain in effect until: (check one)

<input type="checkbox"/> 1 year from date signed	<input checked="" type="checkbox"/> For one time disclosure only	<input type="checkbox"/> Other event or time: <i>(Please specify)</i> _____
--	--	--

5. I understand:

- A. I may decide not to sign this authorization. The provider(s) listed above will not deny me treatment solely for that reason.
- B. If I do sign this authorization, I may revoke it at any time, unless the provider(s) have relied on my authorization and have already disclosed the records. **To revoke this authorization, I need to send a revocation in writing to the provider(s) above.**
- C. The law enforcement agency that receives the records may redisclose them if permitted by law. Only records protected by Federal confidentiality rules 42 CFR part 2 (specified in Section 2. C above), are restricted from redisclosure unless I give written consent, unless redisclosure is permitted by these confidentiality rules, or if ordered by a court.
- D. If I want to know what is in these records, I can contact the provider(s) listed above for access to these records.

Signature of Patient

Date

Signature of Parent/Guardian [if applicable]

Relationship to Patient

6. I hereby verify the identity of the person(s) signing above and that these records will be used for law enforcement purposes only.

Signature of Law Enforcement Officer

Badge or Attorney Bar #

Salt Lake City Police Dept.
 Agency

Print Officer's Name

Agency Case Number

801-799-3000
 Dispatcher's Phone (for verification)

SLCPD Jurisdictional Map.pdf

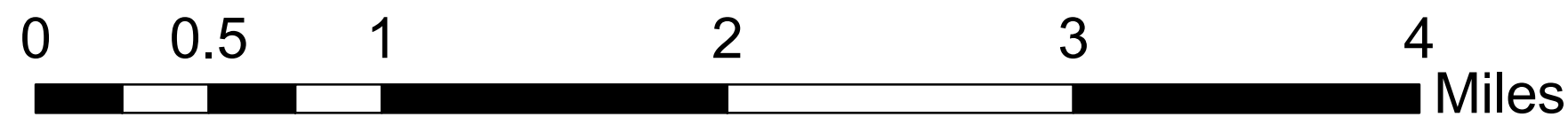
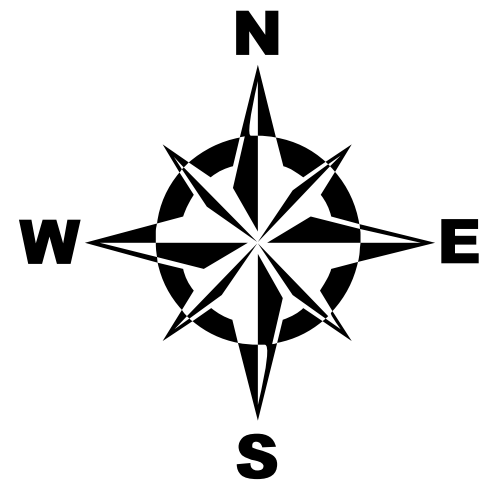
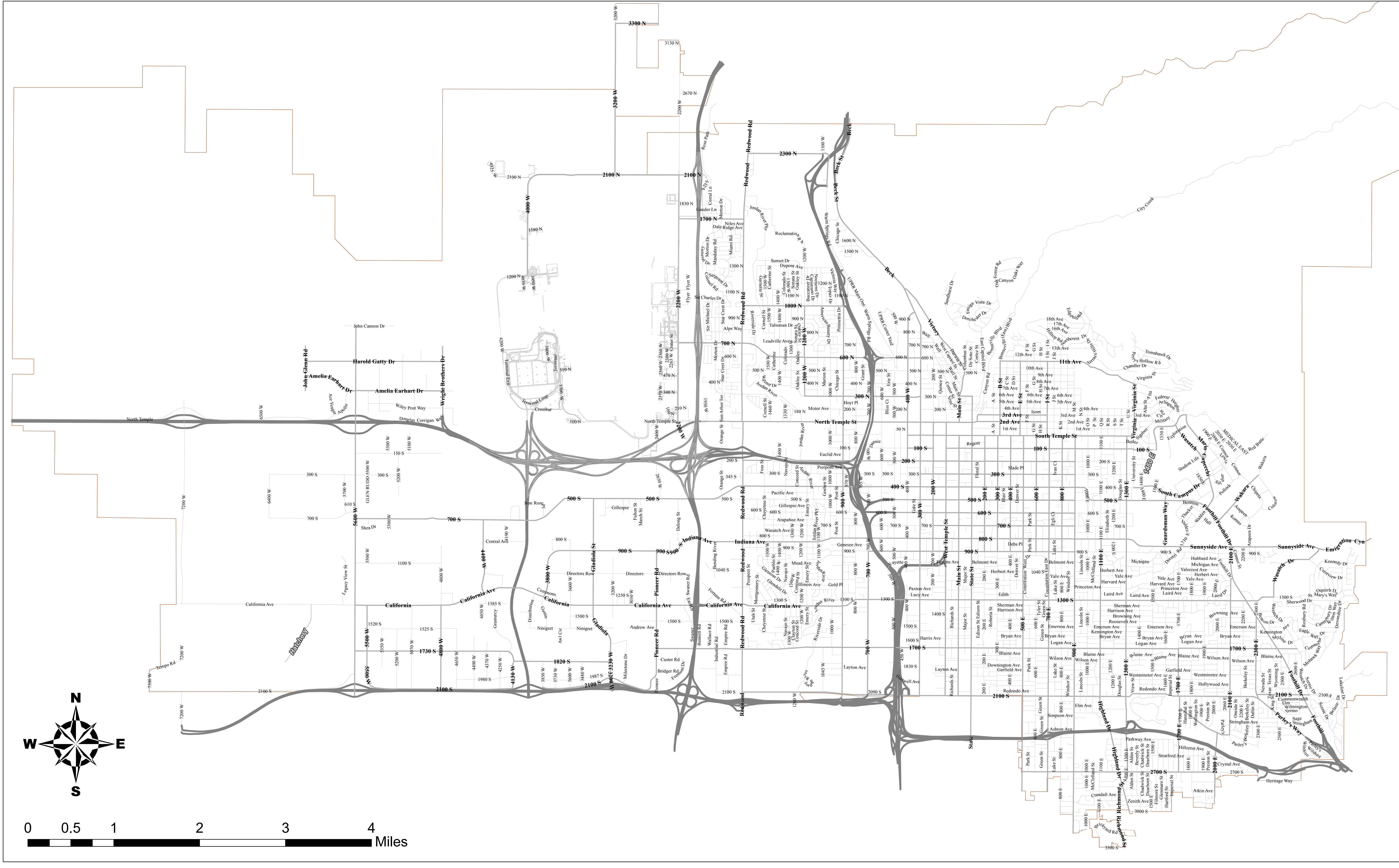

Use of Force Model.pdf

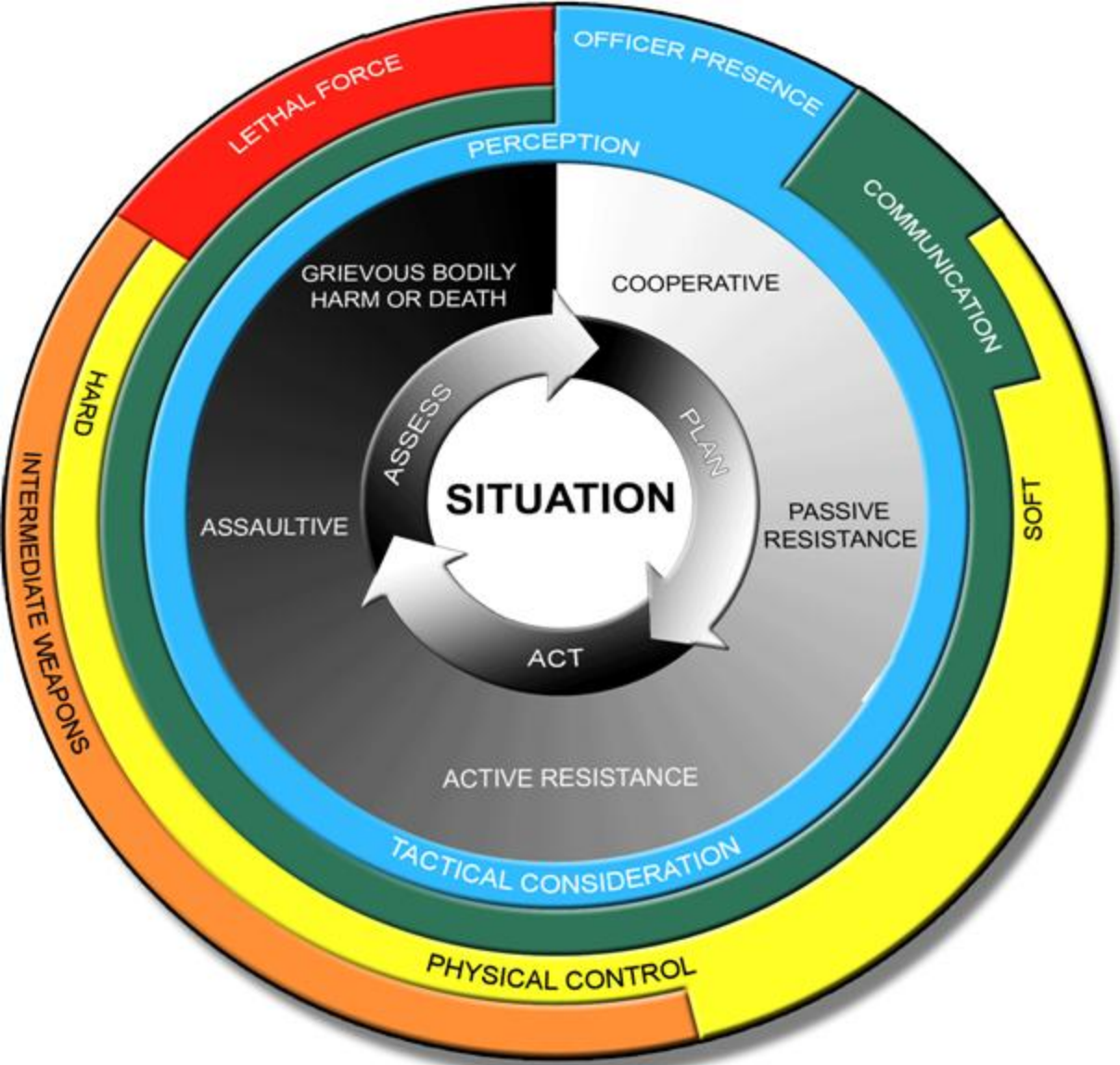

Form 350.pdf

Emergency Medical Service Provider

Exposure Report Form

PLEASE PRINT OR TYPE

Complete this form to document exposure to blood and/or other body fluids. Most unprotected exposures do not result in an infection, however, some people can be exposed to a disease and not have any symptoms of illness. It is important that you document any significant exposure incident.

Significant Exposure – EMS Provider Information

Exposed Provider, use your last initial, first initial, last 4 digits of Social Security number for ID # ex. (ab1234) ID # _____

Employee Name _____ (Last) (First) (M) DOB ____/____/____ Sex _____ M or F

Home Phone _____ Work Phone _____ Employer/Agency _____

Contact Person at Employment / Agency _____ Contact Phone _____

Date _____ Incident # _____

Mechanism of Exposure (check all that apply)

Body Fluid Exposure	Other Body Fluid w/Blood	How Were You Exposed?
Blood	Saliva	Splash in Eye
Birth Fluids	Urine	Splash in Mouth or Nose
Pericardial Fluids	Feces	Bite
Pleural Fluid	Pus	Puncture w/Hollow-bore Needle
Synovial Fluid	Sputum	Puncture Cut w/Other Sharp Implement
Cerebrospinal Fluid	Other	Open Wound
Semen		Rash / Dermatitis
Vaginal Secretions		Abrasion

What protective equipment were you using at the time of exposure? (check all that apply)

Bag-Valve-Mask	One Way Resuscitation Mouthpiece	Paper Gown
Gloves	N-95 Mask	Other
Eye Protection	Surgical Mask (Less than N-95 rating)	

Source of Significant Exposure – Source Patient Information

Source Patient Name _____ Phone Number _____

Source Patient Address _____ (Street Address) DOB ____/____/____
 _____ (City, State, Zip) Sex: M _____ F _____

I hereby give my permission to the facility named below to draw and test my blood for any or all of the following: HIV Antibody, HBV/Surface Antigen and, HCV Antibody. I understand that the results of this testing are private information and will be confidential.

I refuse to have my blood drawn and tested. I understand that a court order may be pursued to require me to have blood testing done.

Source Patient (or responsible) Signature _____ Date ____/____/____

Receiving Facility/Testing Laboratory

Receiving Facility _____ Date Specimen(s) were obtained ____/____/____

Testing Laboratory _____ Date Specimen(s) were submitted ____/____/____

Did patient expire? Yes No Was the patient under the jurisdiction of the State Department of Corrections (Prisoner or Parolee)? Yes No

Name of Person submitting report _____

Title _____ Phone Number _____ Date Report was submitted ____/____/____

If onsite post exposure counseling is not available contact any of the following. <http://www.ucsf.edu/hivcntr/Hotlines/PEPline.html> 24/7
 Or call (800) 537-1046. (801) 538-6096 or (800) FON-AIDS 8-5 M-F (hospital clinicians may receive 24/7 help with PEP counseling by calling 1-888-448-4911)

The Laboratory must report the test results of the source patient testing to the EMS Agency/Employer Contact person listed above.

* The EMS Agency/Employer must submit the Employer's First Report of Injury/Illness (Form 122) when this form is completed by an EMS Provider.



Official Form 350 Revised 8/2012

State of Utah * Labor Commission * Division of Industrial Accidents

160 East 300 South * P.O. Box 146610 Salt Lake City, UT 84114-6610 * Telephone: 801-530-6800

Fax: 801-530-6804 * Toll Free: (800) 530-5090 * www.laborcommission.utah.gov

Crash Diagram For Patrol.pdf

Crash Diagram

Diagramming

- Four methods:
 - Field sketch
 - Photogrammetry
 - Total station
 - FARO

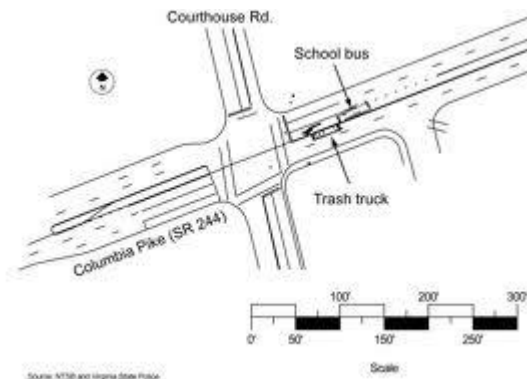

Purpose:

- To create a scale diagram for accident reconstruction

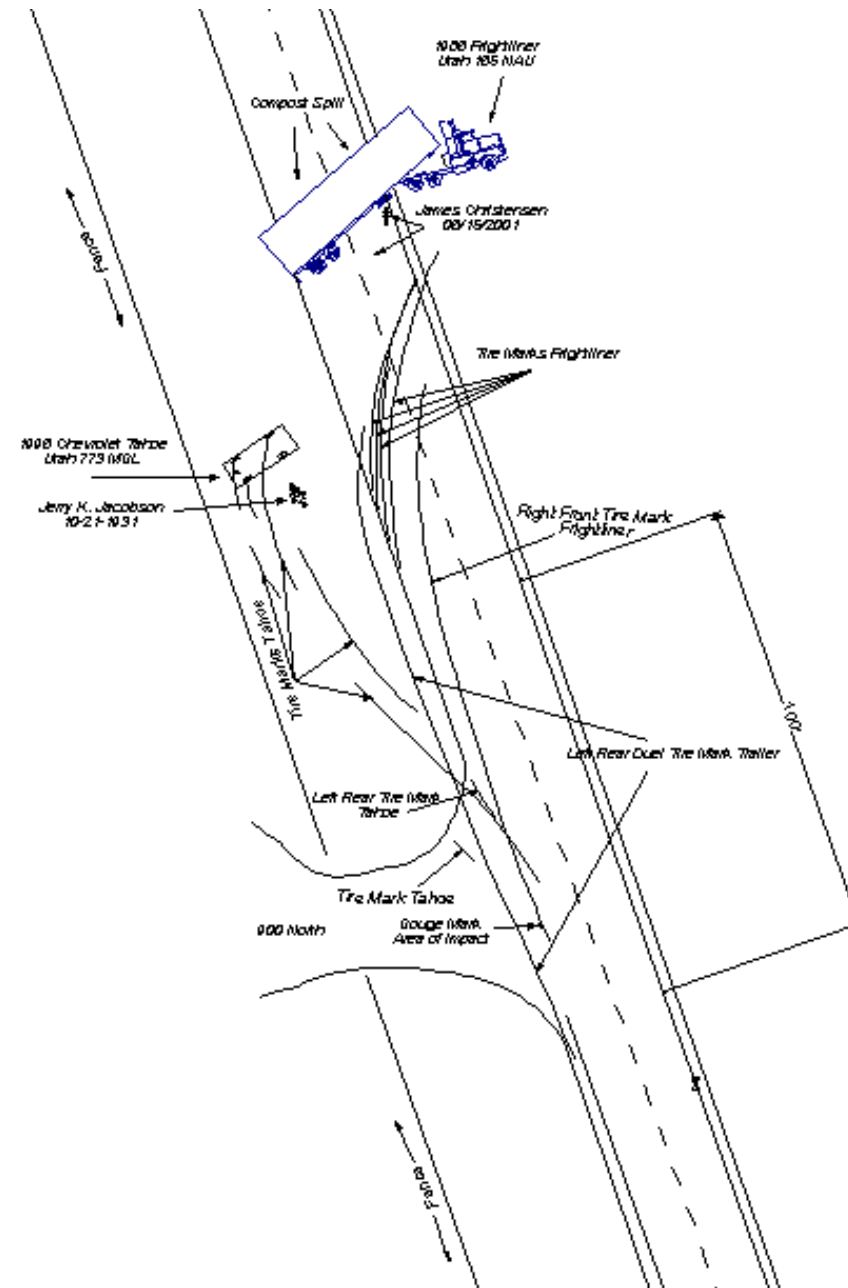

- **Scale vehicles are placed on the diagram**
- **Measurements are taken from diagram**
- **Center of Mass of vehicles is used**

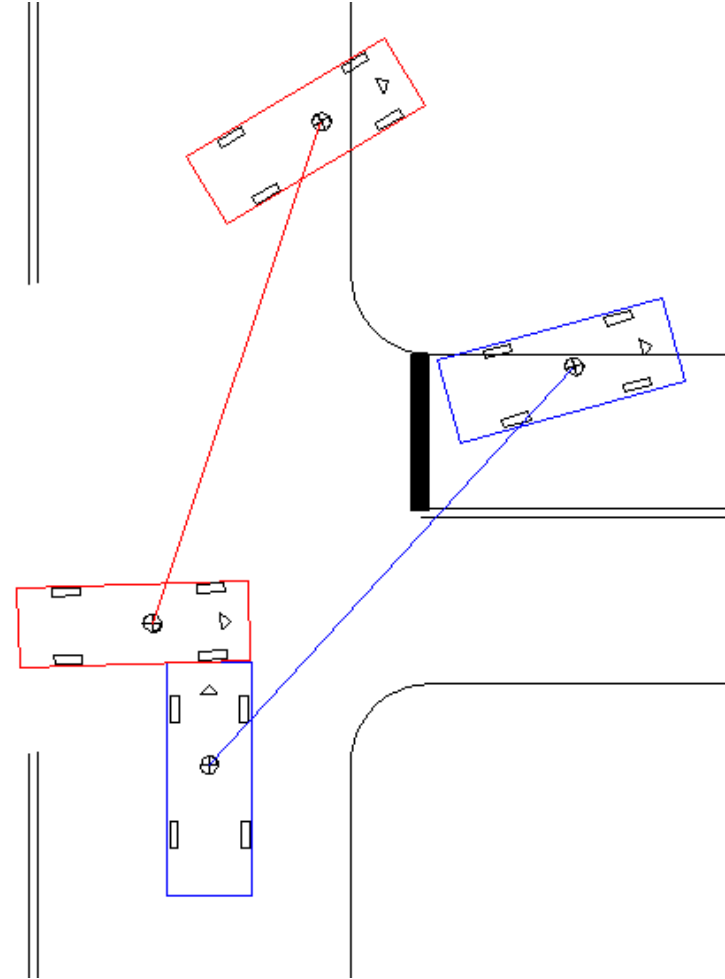

So everything necessary for the reconstruction needs to be on the diagram

- Gouges – Point of Impact
- Vehicle Positions – Final Rest
- Tire Marks – Vehicle Travel Paths, Braking
- Body Positions



The **Investigating Officer should be
the one to make the field
diagram**



**He will be the one
defending it in
court**

Steps

Designate reference point and edge

Draw out the scene

Pick points to measure

Measure roadway

Measure points



Reference Point

Must be permanent

Generally no poles



No mile markers

Aren't exact and they move



Stakes driven into the ground

Reference Line or Edge

Pick your Reference Line to measure from:

- Easily Identified**
- Works well with RP**
- Works best with scene**
- Don't use painted lines**

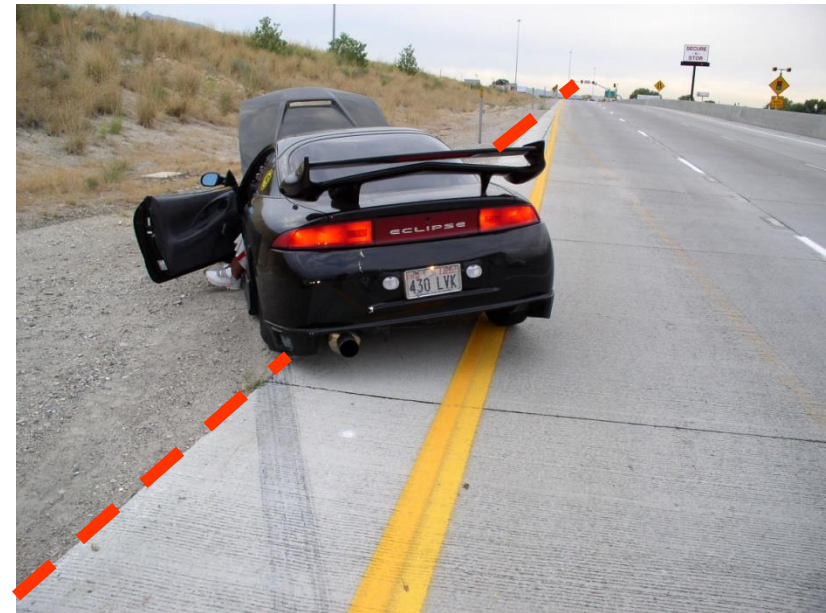
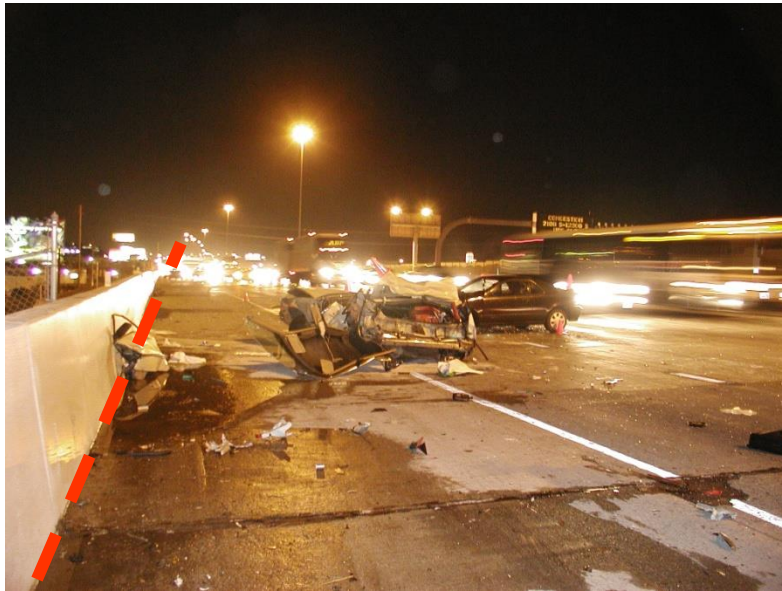

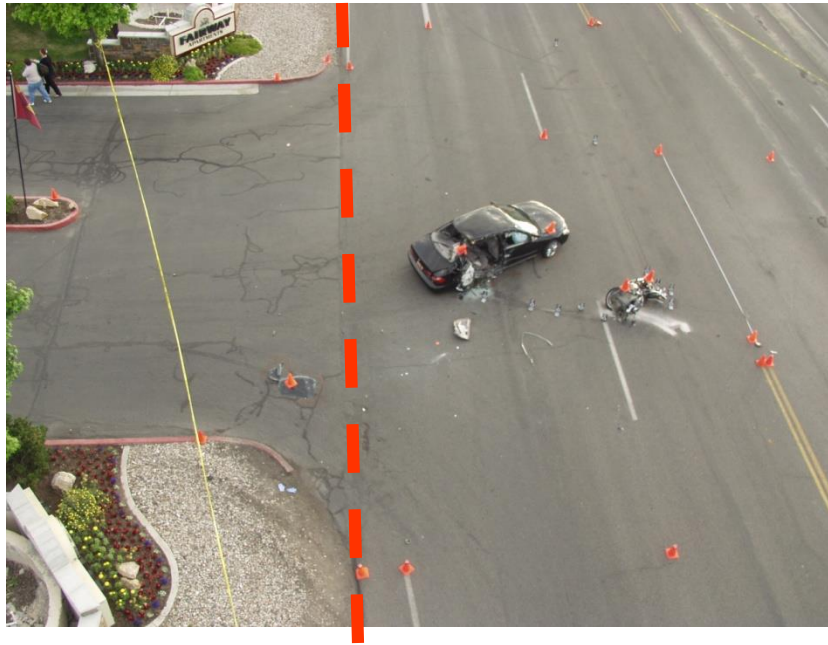

**Curb line or
extension of
curb line**

**Can be
a line
between
two points**



Draw the Scene

Create a sketch of the scene.

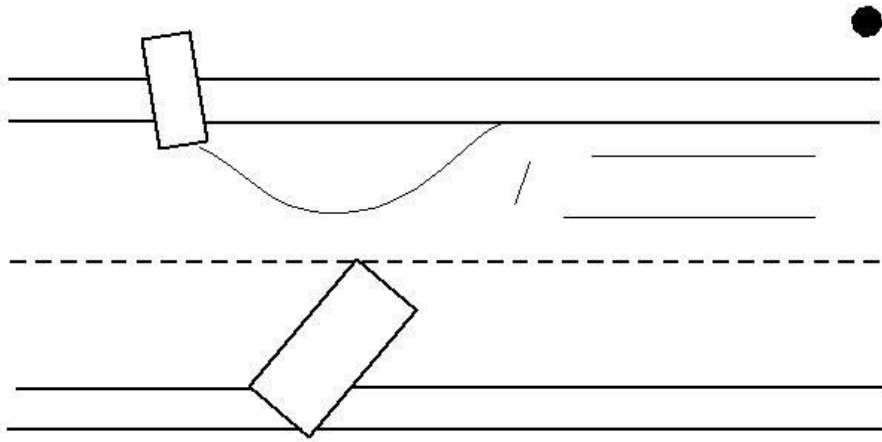

- Include **everything** relevant to the crash
- When in doubt put it in

**Use your
template**

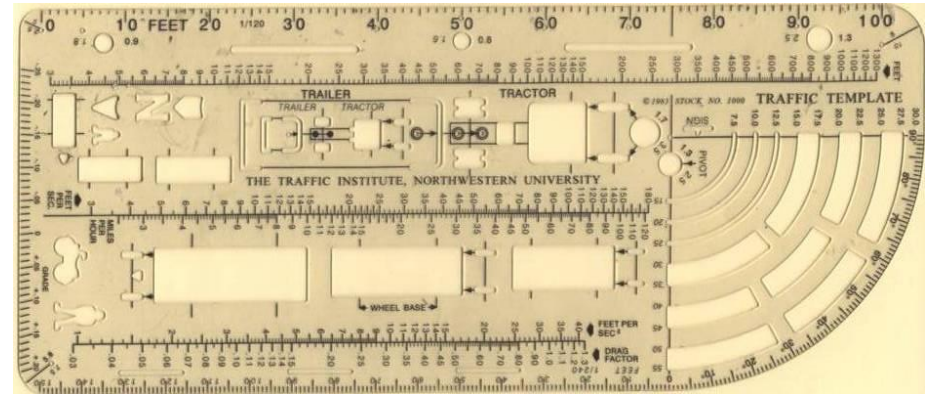

Points

Locate all points to measure

**Label them using
letters**

Use A-Z, then AA, AB, AC, AD...

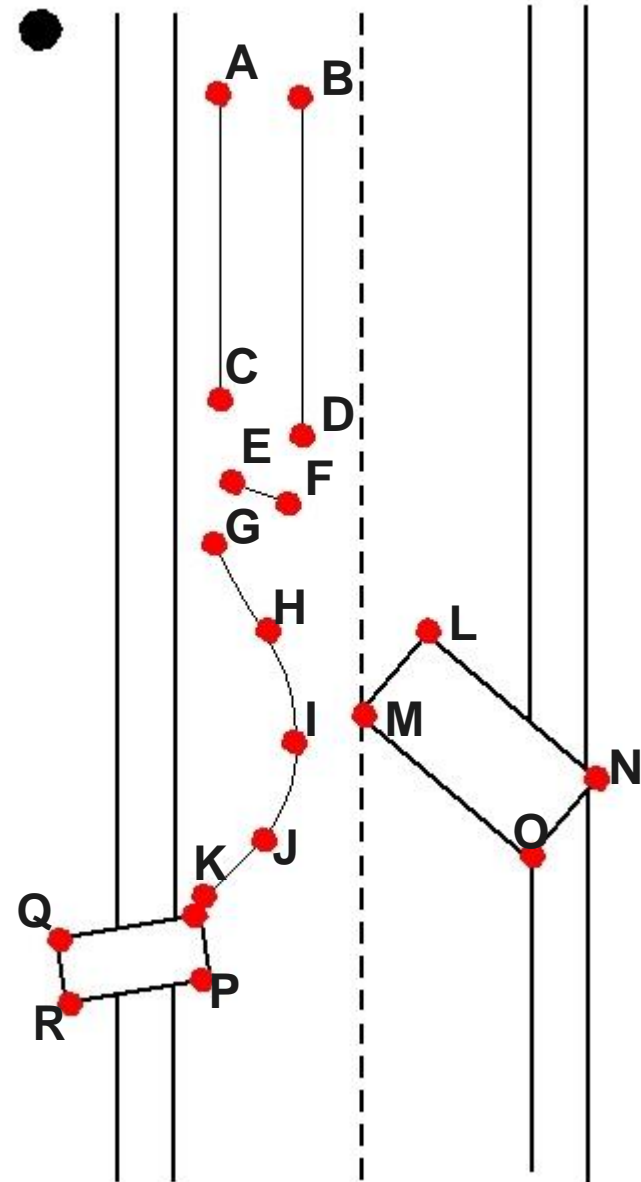

What to Record

Tire Marks - skids, yaws, scars and imprints



Debris



Position of rest of
vehicles and bodies



Position of witnesses

Other potential contributors



Vehicles

Generally the **tire positions** are recorded.

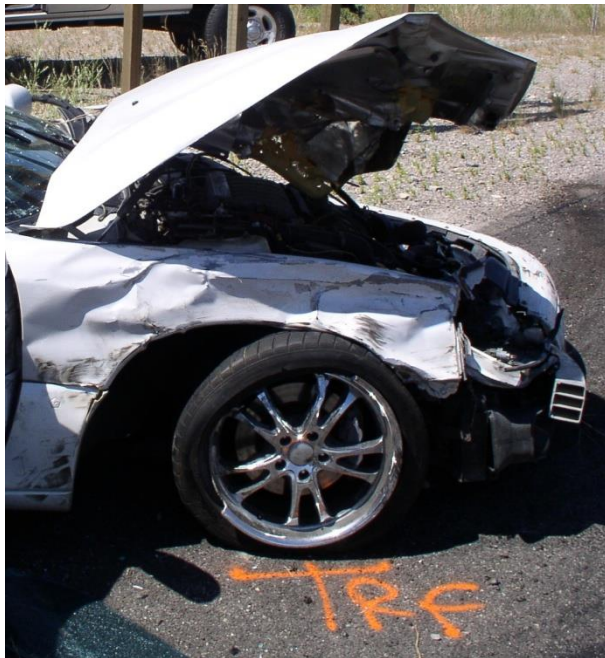

Mark at least 2 tires.

Vehicle Position of Rest

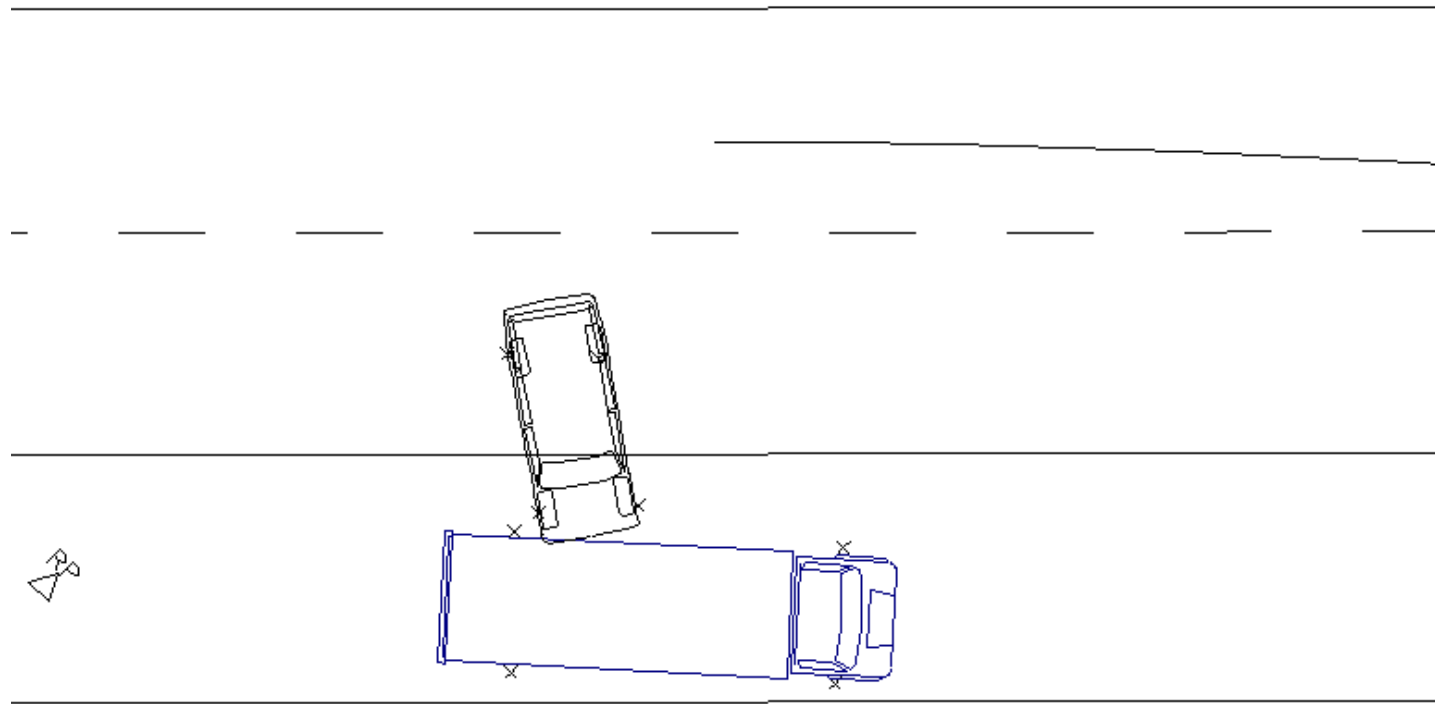

Bodies

- Head and Feet

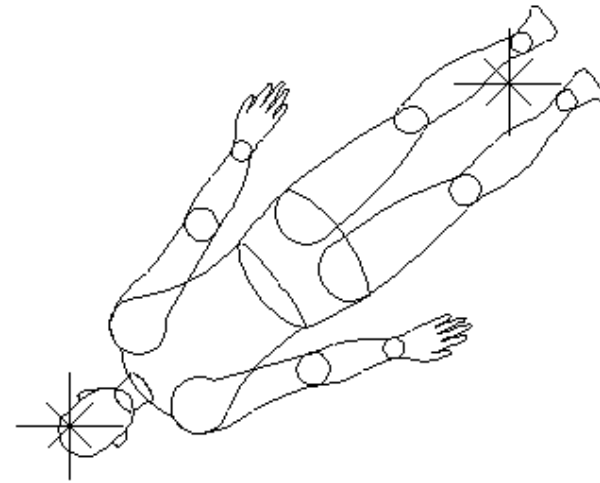

Debris

For **single pieces** or
small areas **one or two**
points
is sufficient.

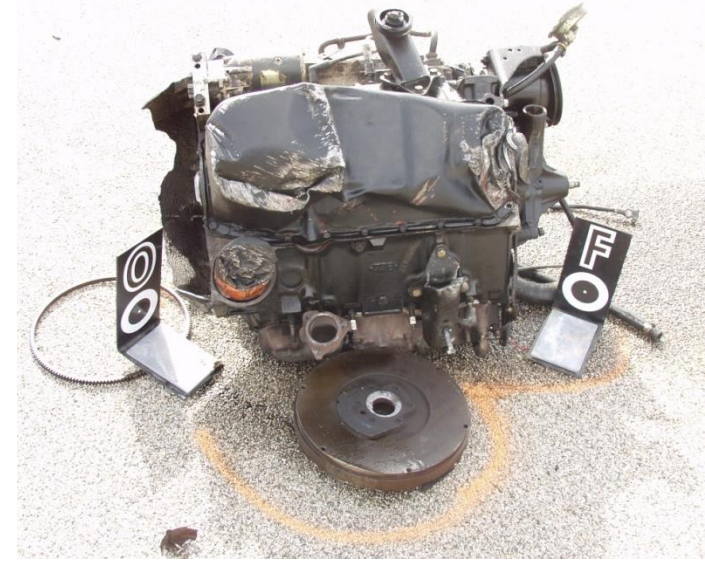

For **large**
fields
use **3 or**
more points

Tire Marks

- 1 point is sufficient:
 - Marks under 3 ft. long.
 - Gouges
 - Scrubs
 - Scars



- **2 points are needed:**
 - **Straight marks over 3 ft.**



Recording a Curve

2 points aren't sufficient for a curve

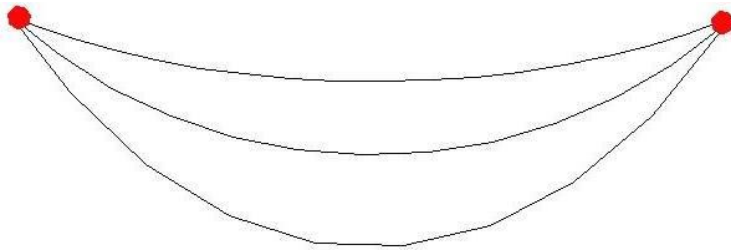

Can't tell how **wide**
the curve is

Or which **way it arcs**

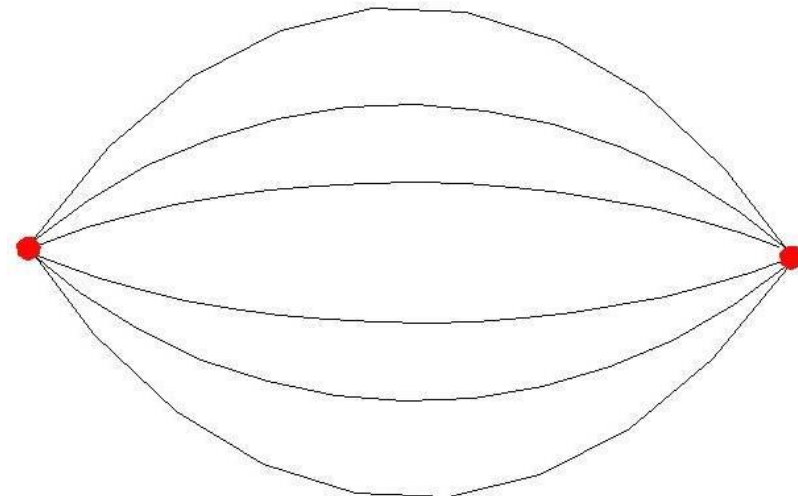

Use many points for yaw marks over 8 ft.

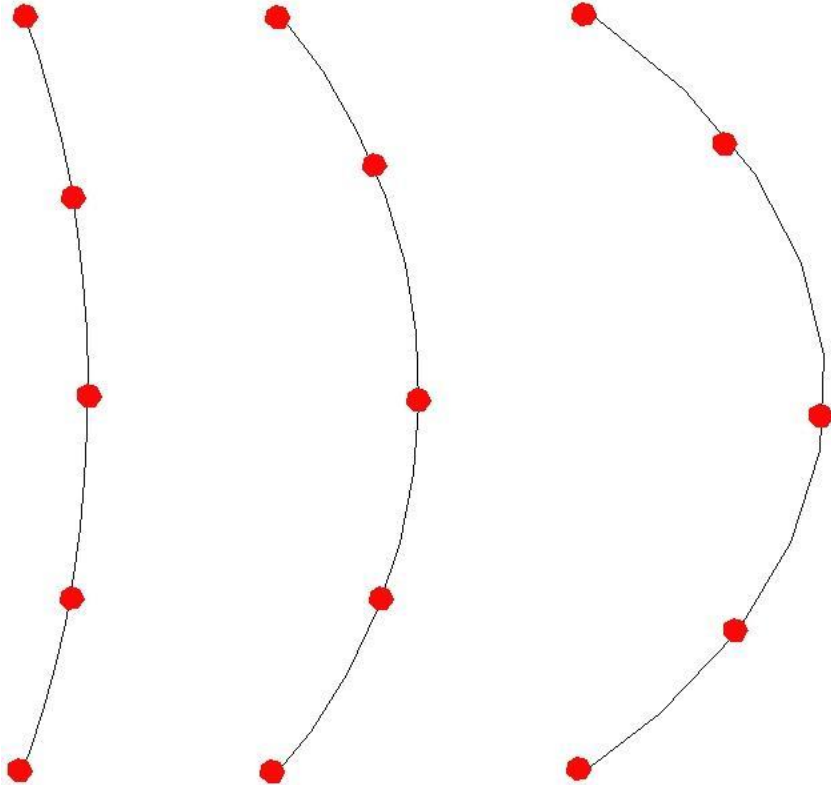

For Reconstruction:

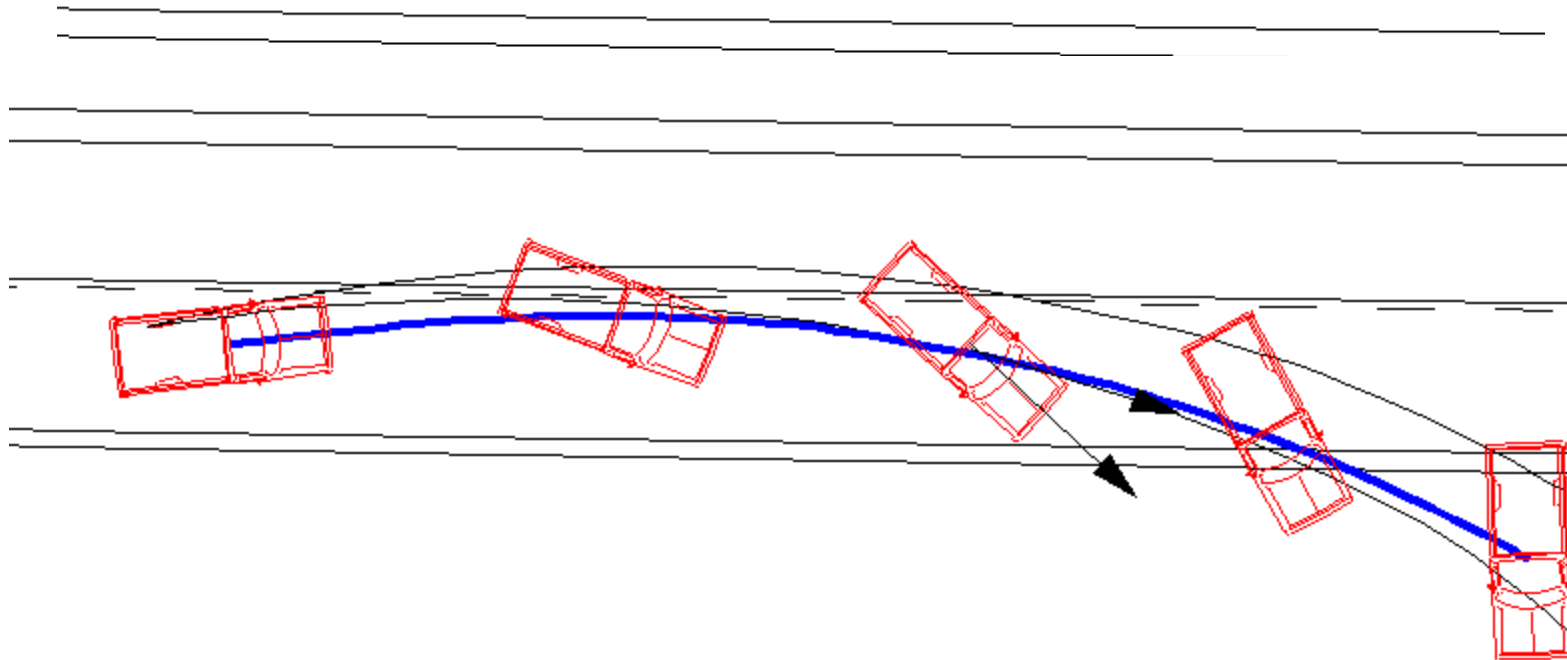

Do the same for curbs:

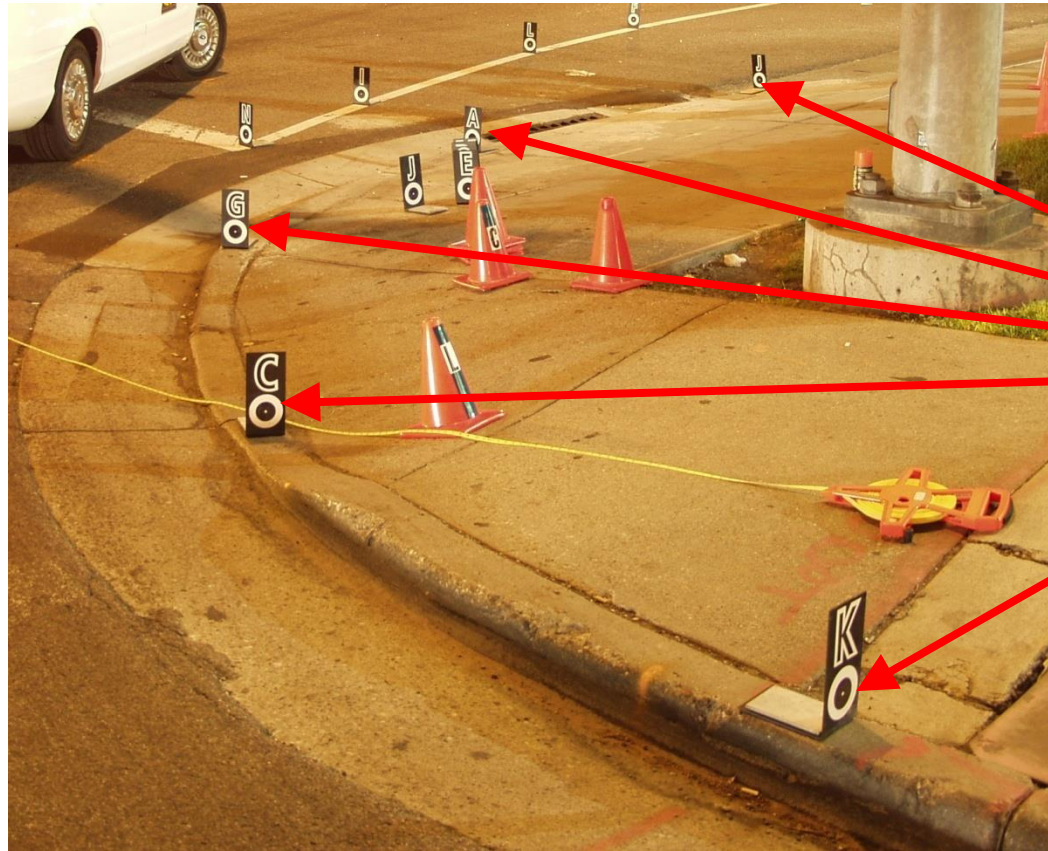

Measure Roadway

Measure the width
of each lane

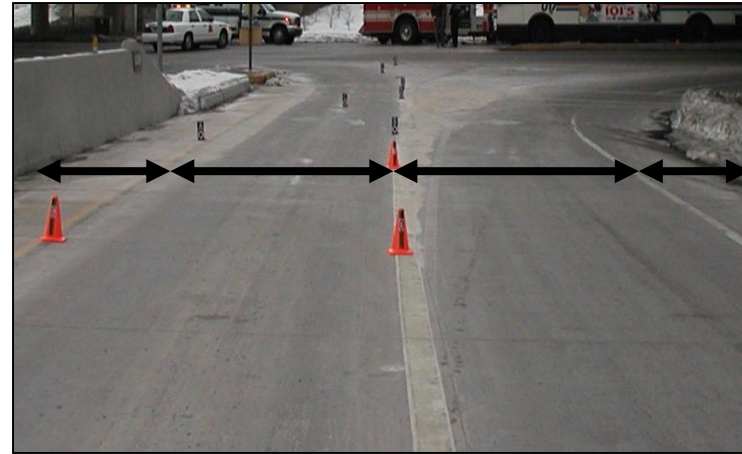

Write the
measurements
on the sketch

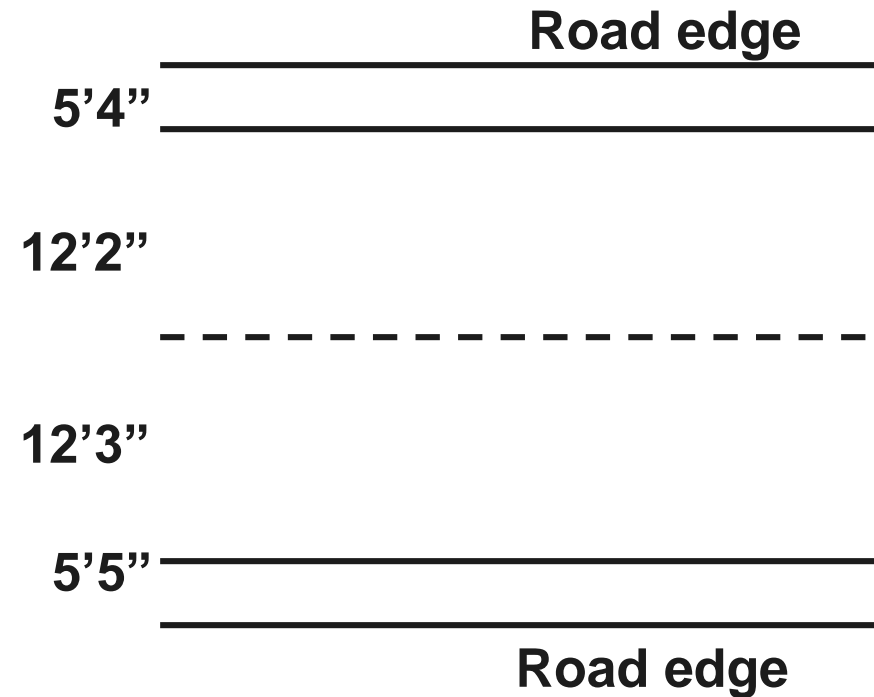

Coordinate System

Two measurements are taken of every point:

The distance from a reference point (RP)

The distance from an edge



How to Measure

Start at end with RP.

Measure the distance from RP to nearest point, along the edge.

Measure the distance from edge to point

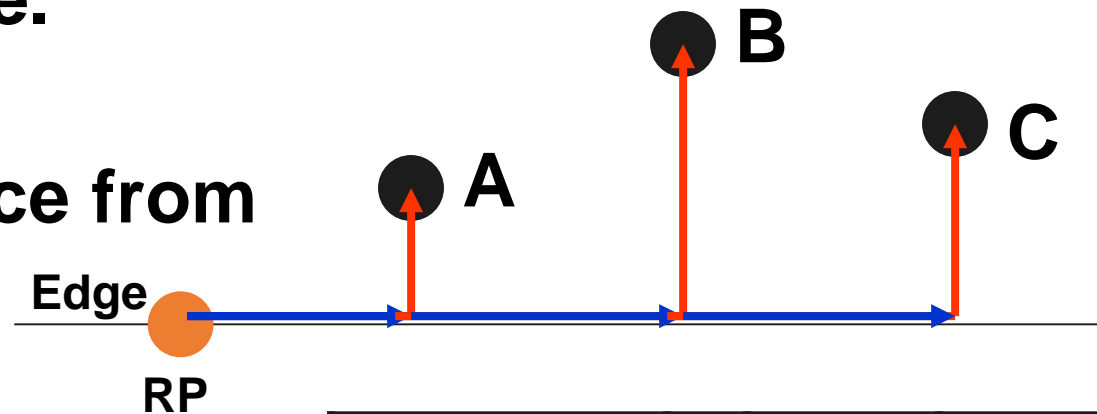

Continue along edge for remaining points

Letter Location		RP	Edge
First	A	$10 \frac{5}{s}$	$5 \frac{5}{E}$
Second	B	$20 \frac{5}{s}$	$10 \frac{5}{E}$
Third	C	$30 \frac{5}{s}$	$7 \frac{5}{E}$

Notation

$$15' 5'' \rightarrow 15 \frac{5}{s}$$

The distance in feet is written out first

The inches are written in superscript next to feet

The direction from the RP is written under the inches. They are separated by a line.

Example

A car swerves off the road and rolls, ejecting an occupant, who dies.

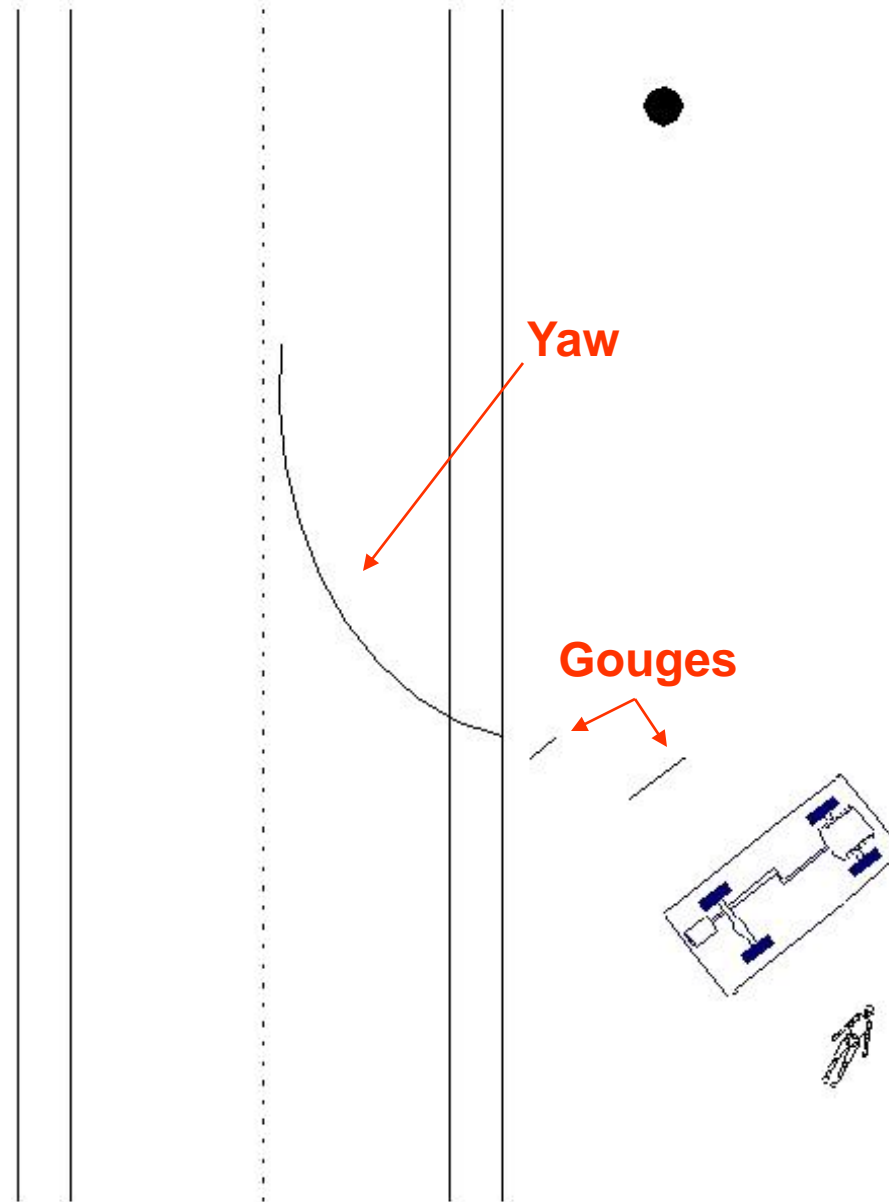

Set-up

Pick reference point.

Pick edge.

Measure roadway

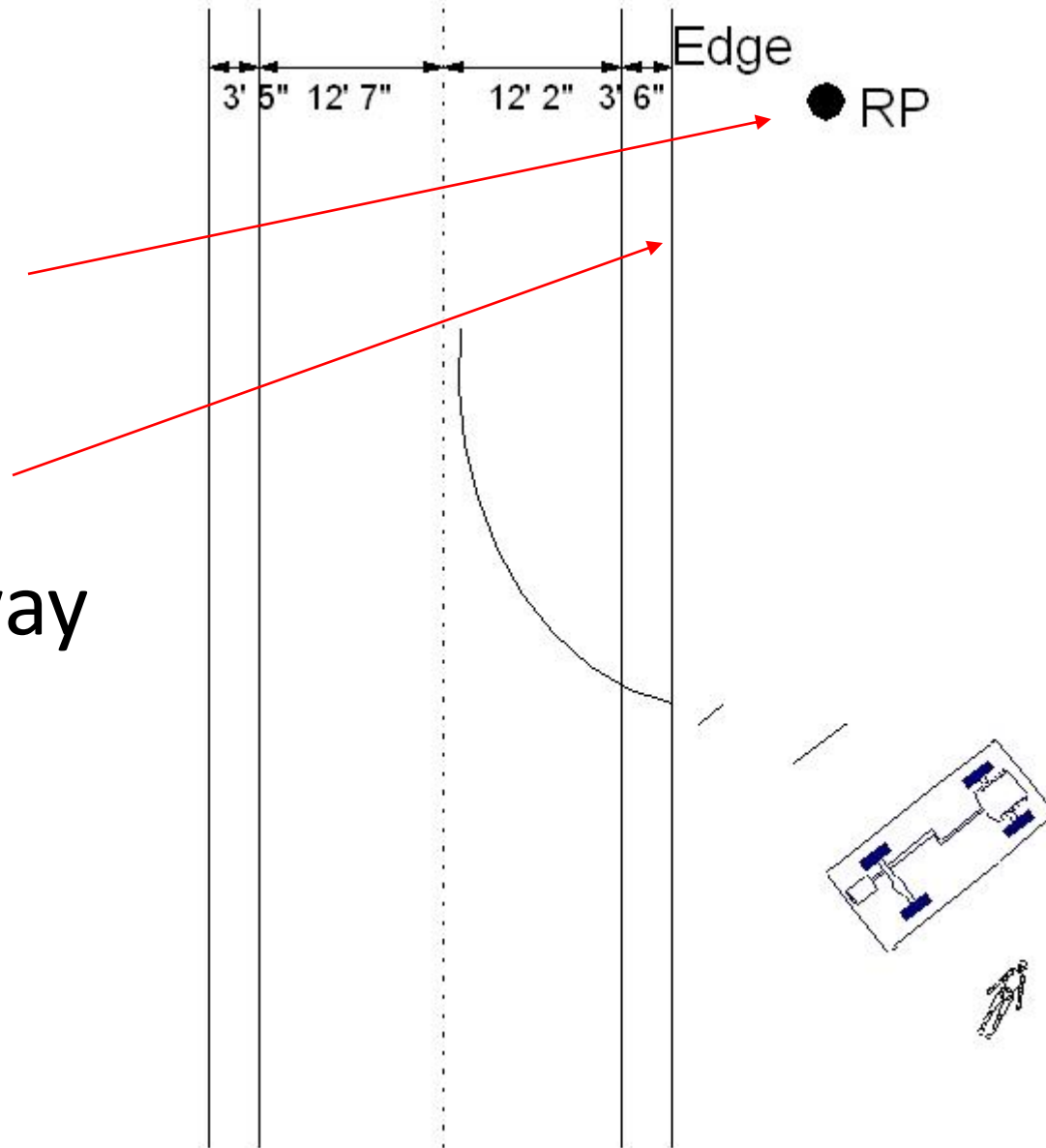

Choose Points

Use multiple points on curve

One point for small gouge

2 points for large gouge

Mark tires of vehicle

2 points for body

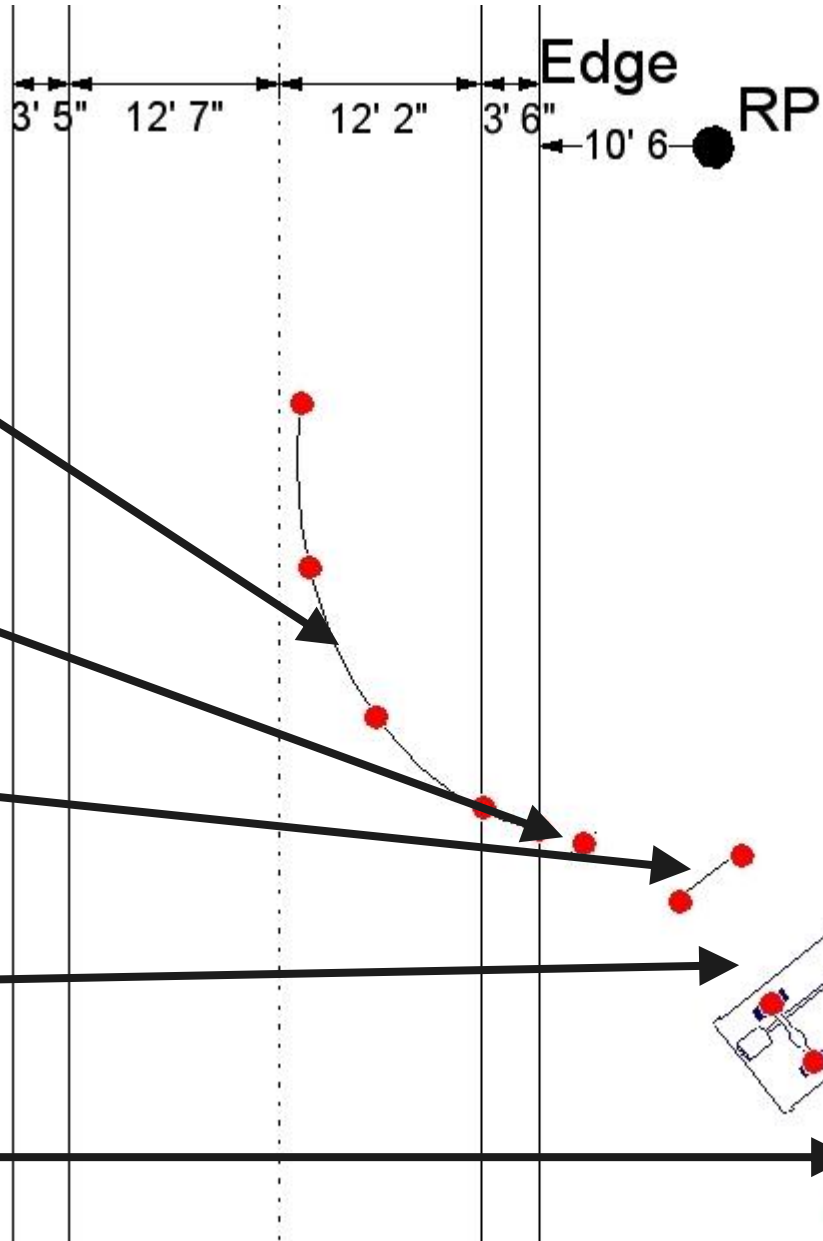

Label Points

Letter Location		RP	Edge
Begin Yaw	A		
Yaw pt 2	B		
Yaw pt 3	C		
Yaw right fog line	D		
Yaw on edge	E		
1 st Gouge	F		
2 nd Gouge E end	G		
2 nd Gouge W end	H		
Right Front Tire	I		
Left Front Tire	J		
Right Rear Tire	K		
Left Rear Tire	L		
Head	M		
Feet	N		

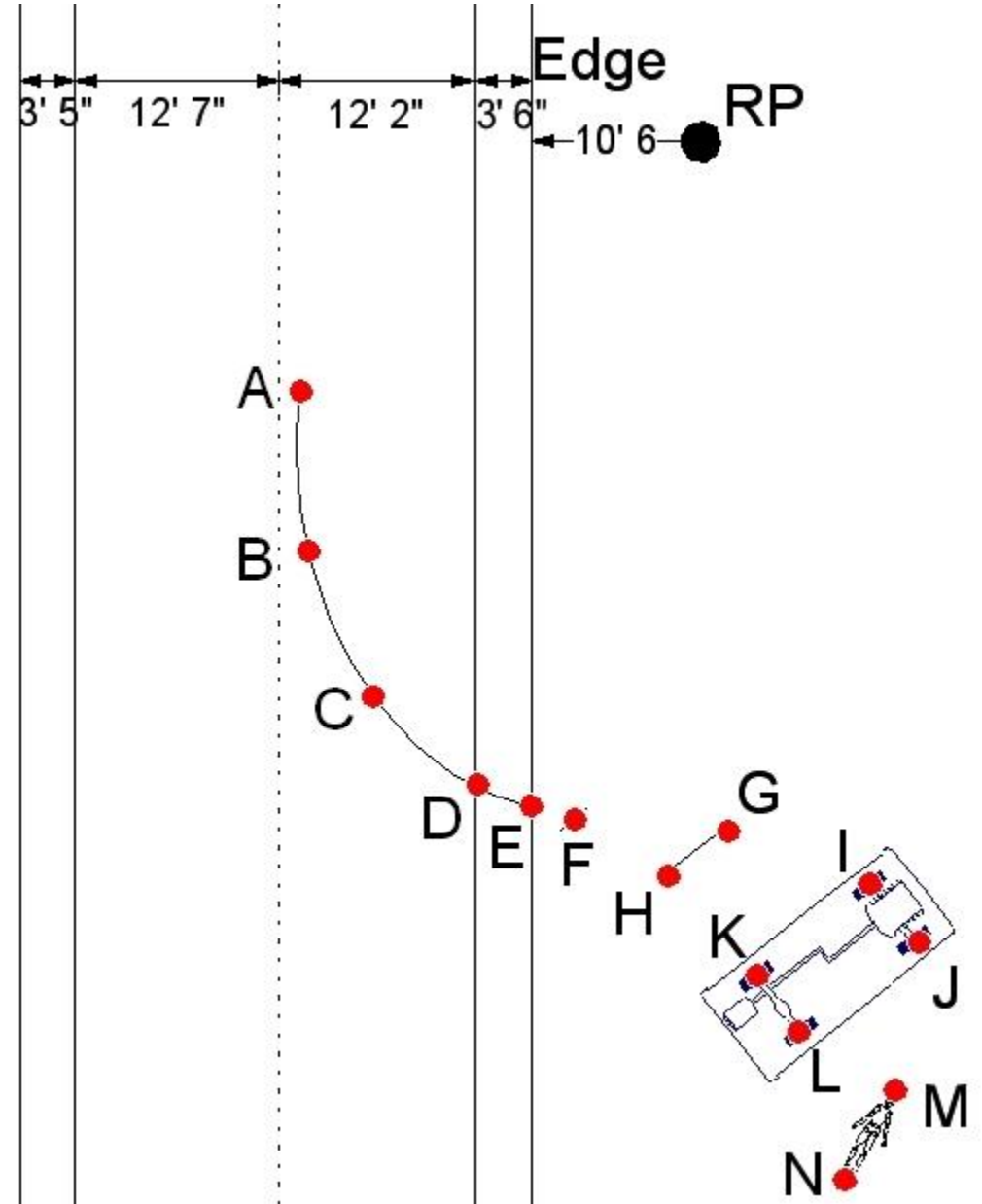

Measure A

Place tape on edge at RP. Measure along the edge to first point.

This is RP measurement

Letter Location		RP	Edge
Begin Yaw	A	15 ⁵ / _S	

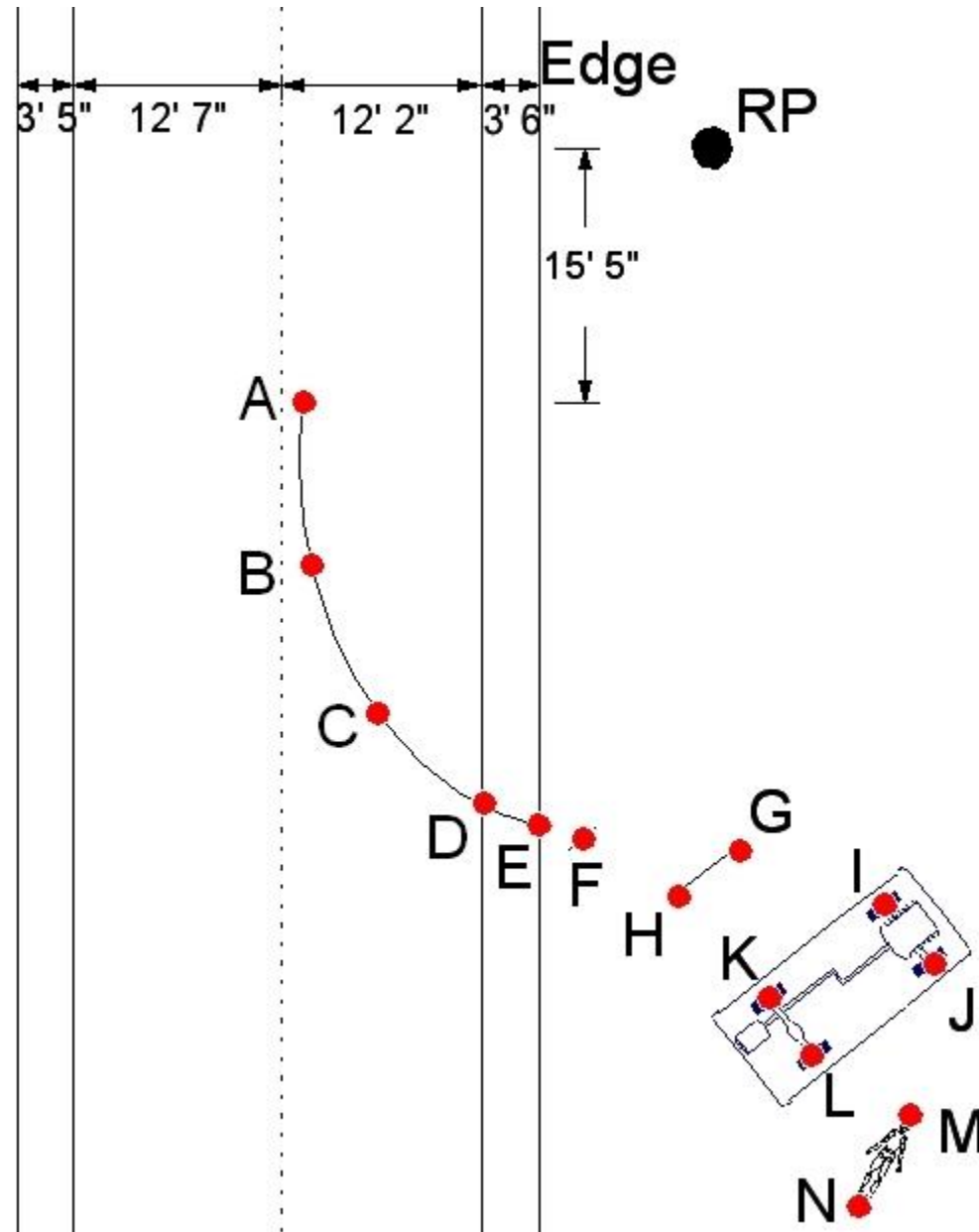

**Measure distance
from the edge to
the point.**

**This is the “Edge”
measurement**

Letter Location		RP	Edge
Begin Yaw	A	$15^{\circ} 5'_{S}$	$15^{\circ} 4'_{W}$

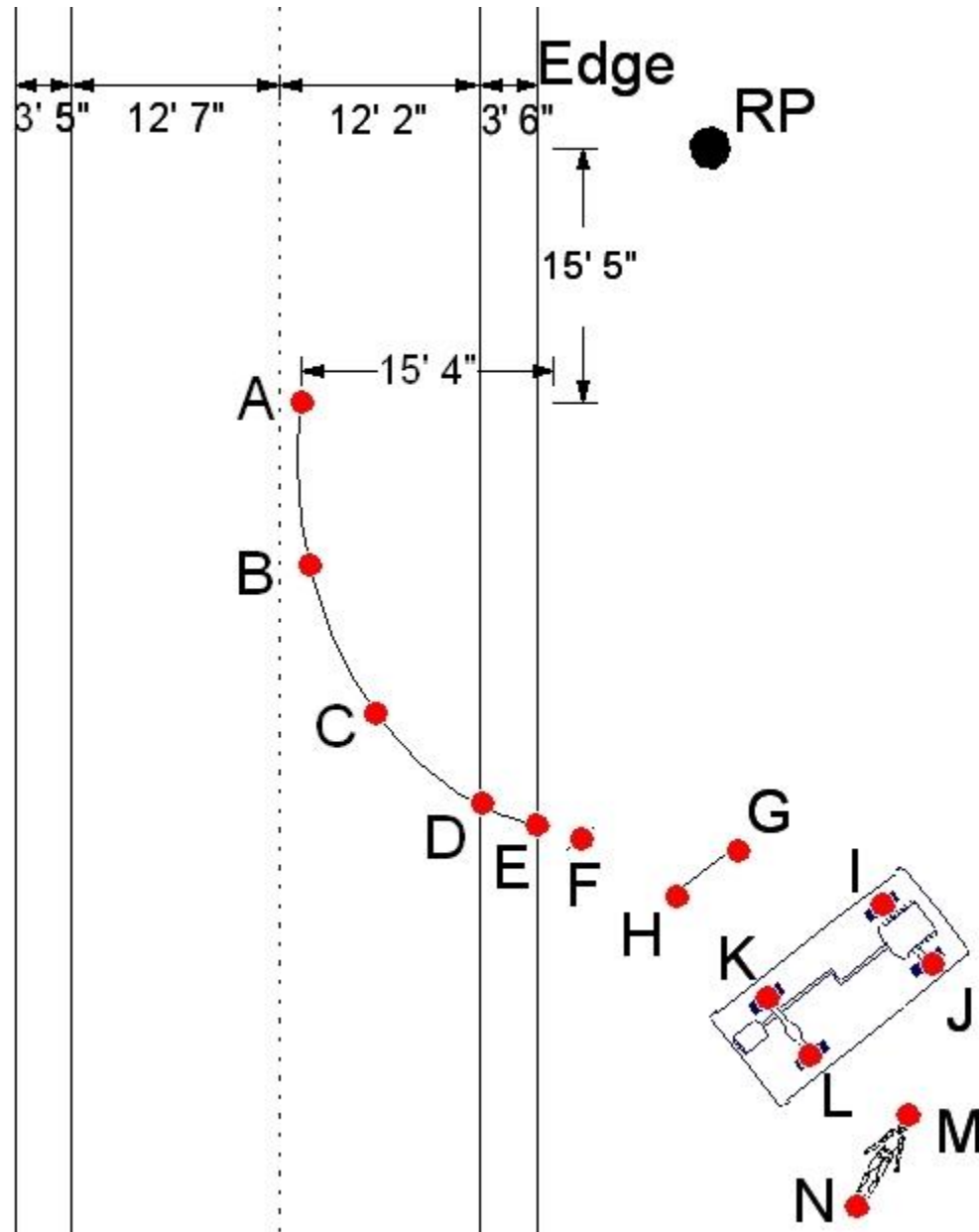

Point on the Edge

Measure distance from RP
Edge distance is 0

Letter Location		RP	Edge
Yaw on edge	E	41 1/8	0

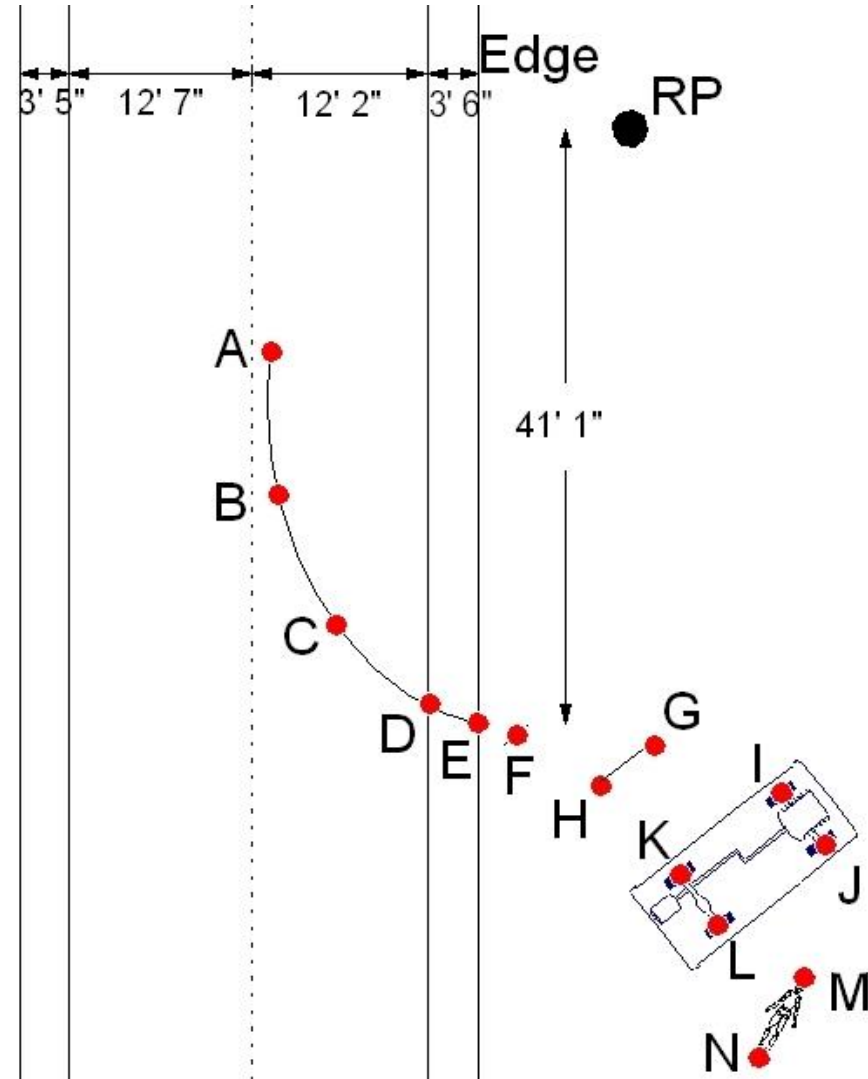

Make sure to record
right direction

Letter Location		RP	Edge
Yaw right fog line	D	$38 \frac{9}{s}$	$3 \frac{6}{w}$
Yaw on edge	E	$41 \frac{1}{s}$	0
1 st Gouge	F	$41 \frac{11}{s}$	$2 \frac{7}{E}$

D is West of the Edge

F is East of the Edge

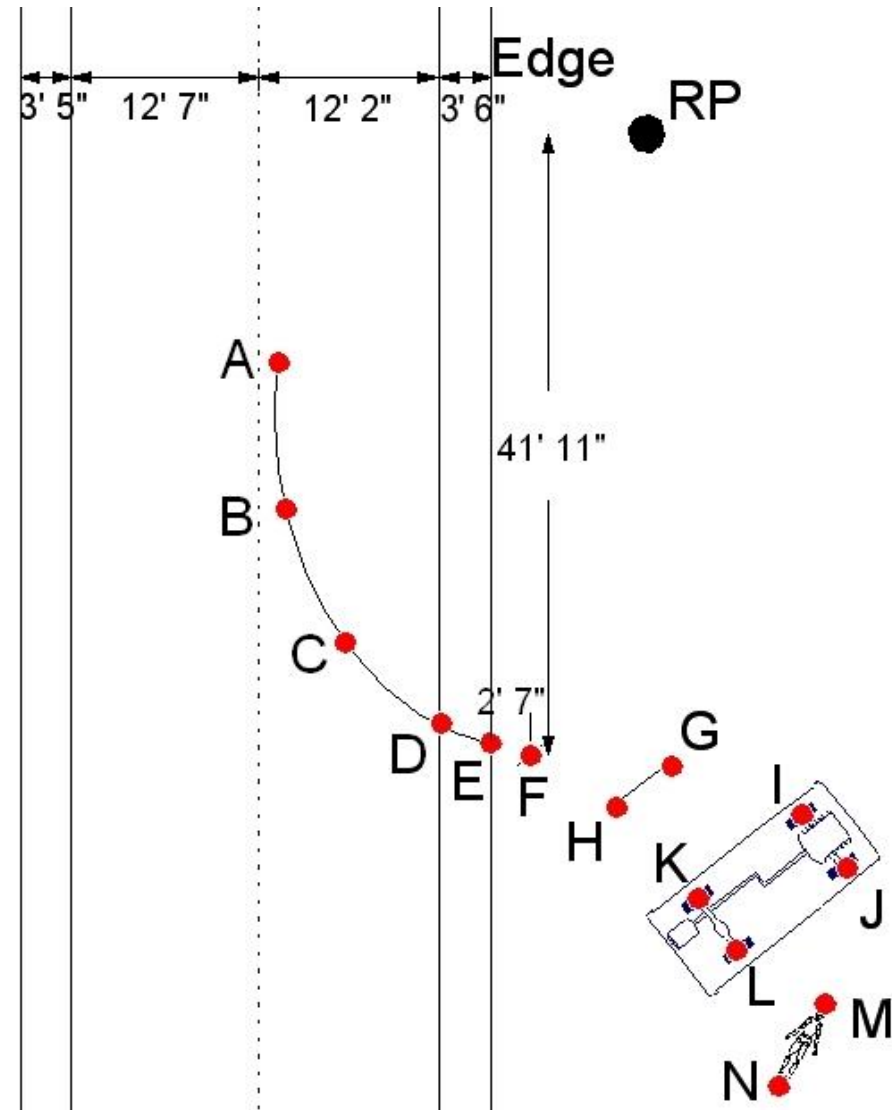

Bends in the Road

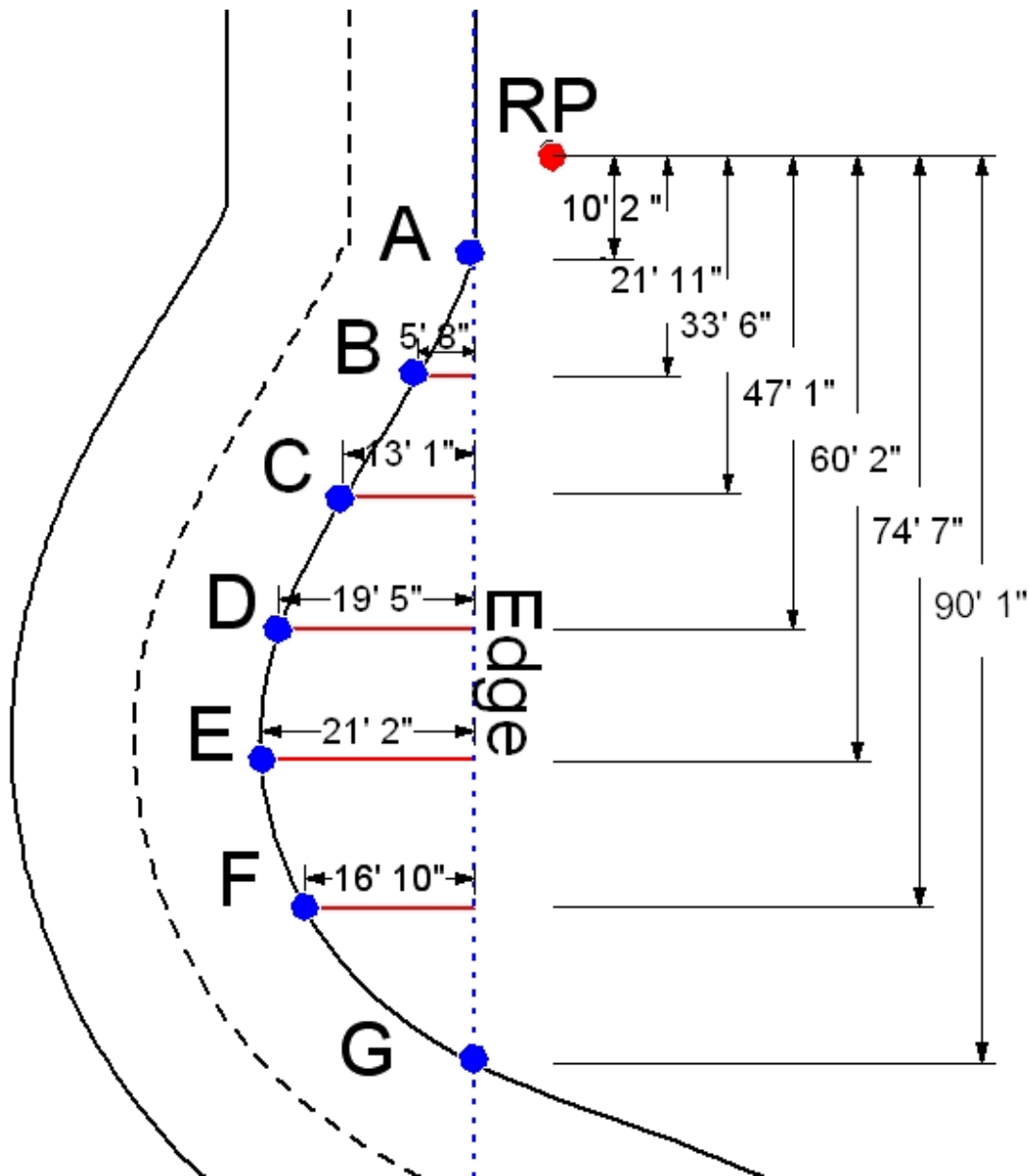

	RP	Edge
A	10 $\frac{2}{S}$	0 $\frac{0}{W}$
B	21 $\frac{11}{S}$	5 $\frac{8}{W}$
C	33 $\frac{6}{S}$	13 $\frac{1}{W}$
D	47 $\frac{1}{S}$	19 $\frac{5}{W}$
E	60 $\frac{2}{S}$	21 $\frac{2}{W}$
F	74 $\frac{7}{S}$	16 $\frac{10}{W}$
G	90 $\frac{1}{S}$	0 $\frac{0}{W}$

Other techniques

Intersection: can use 2 reference edges, **The Curb Lines**

Take 2 measurements for every point, one **perpendicular from each line**

Letter Location		RL1	RL2
Left Rear Tire	A	$26 \frac{9}{w}$	$11 \frac{8}{s}$

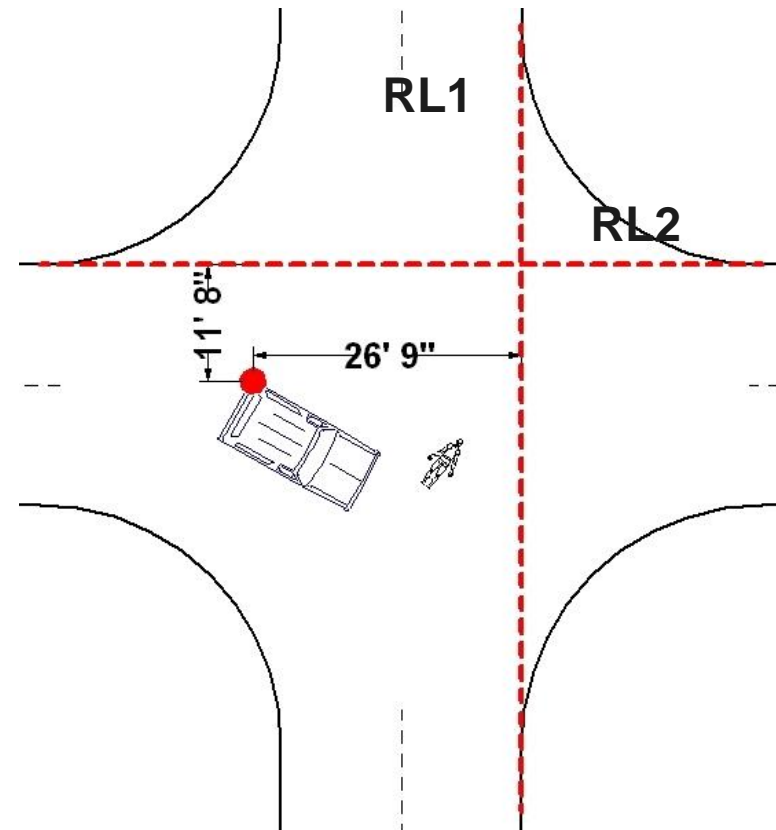

Triangulation

Triangulation uses **2 reference points** instead of a reference point and a reference line

Times to use:

Edges obscured

Far off the road

Road with many bends

Any other time it's convenient



Example

A car runs off the road and into a tree. Due to the curved road you decide to use triangulation.

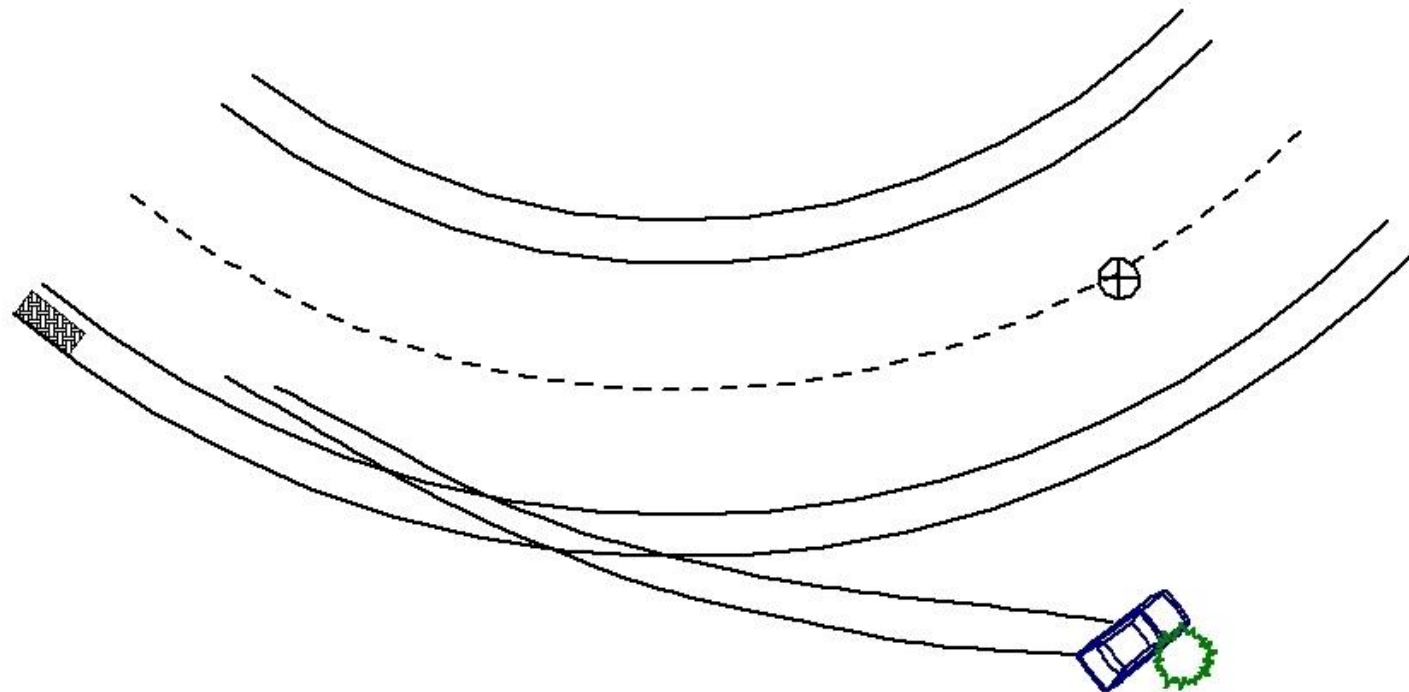

Pick the reference points:

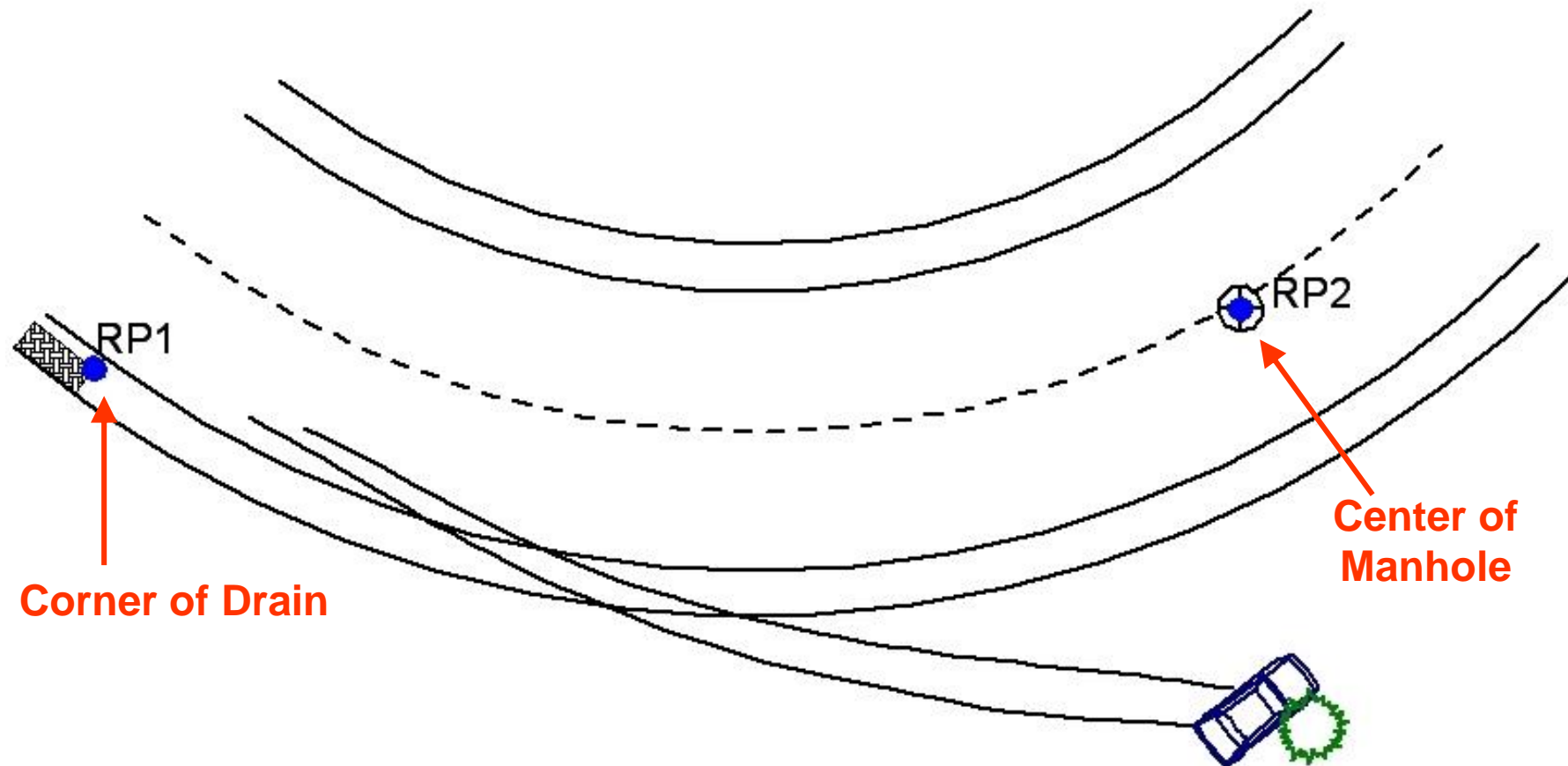

Pick the points to measure:

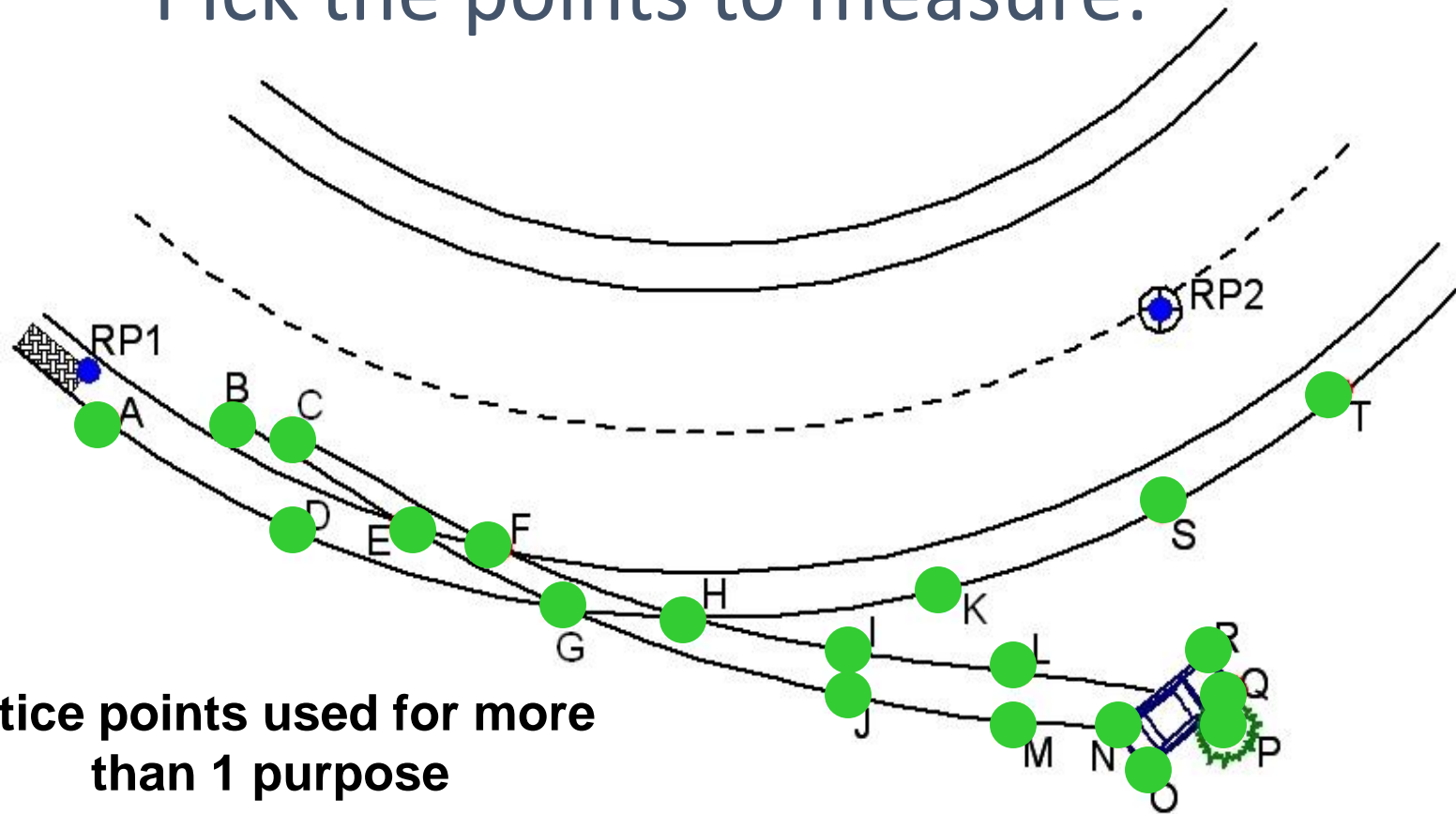

Notice points used for more than 1 purpose

Multiple points on the road for the bend.

The 4 tires of the vehicle.

Multiple points on the skids. The tree the vehicle hit.

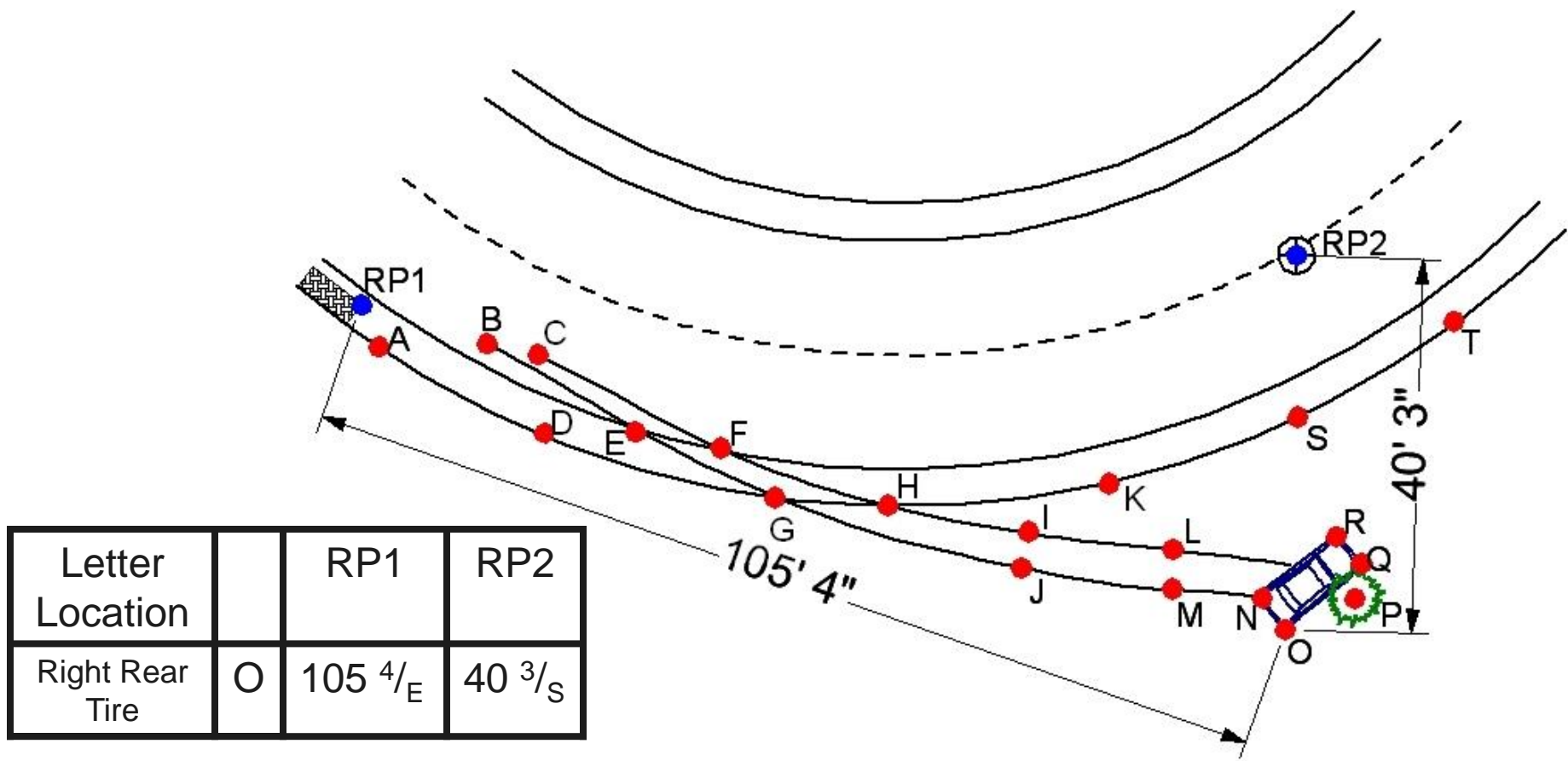

To measure a point:

Measure the distance from the first RP

Then the distance from the second RP.

False Result

The measurements give **2 possible locations** of a point

Letter Location		RP1	RP2
Right Front Tire	A	$40\frac{3}{N}$	$28\frac{5}{S}$

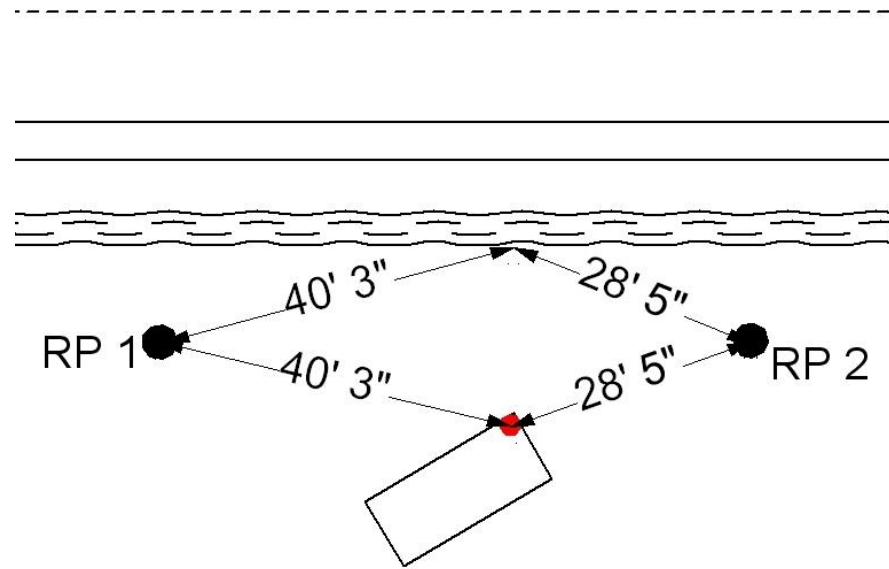

Make sure you have a well drawn field sketch so the right location can be used.

Reference Line

Make sure to measure the curve of the road with multiple points.

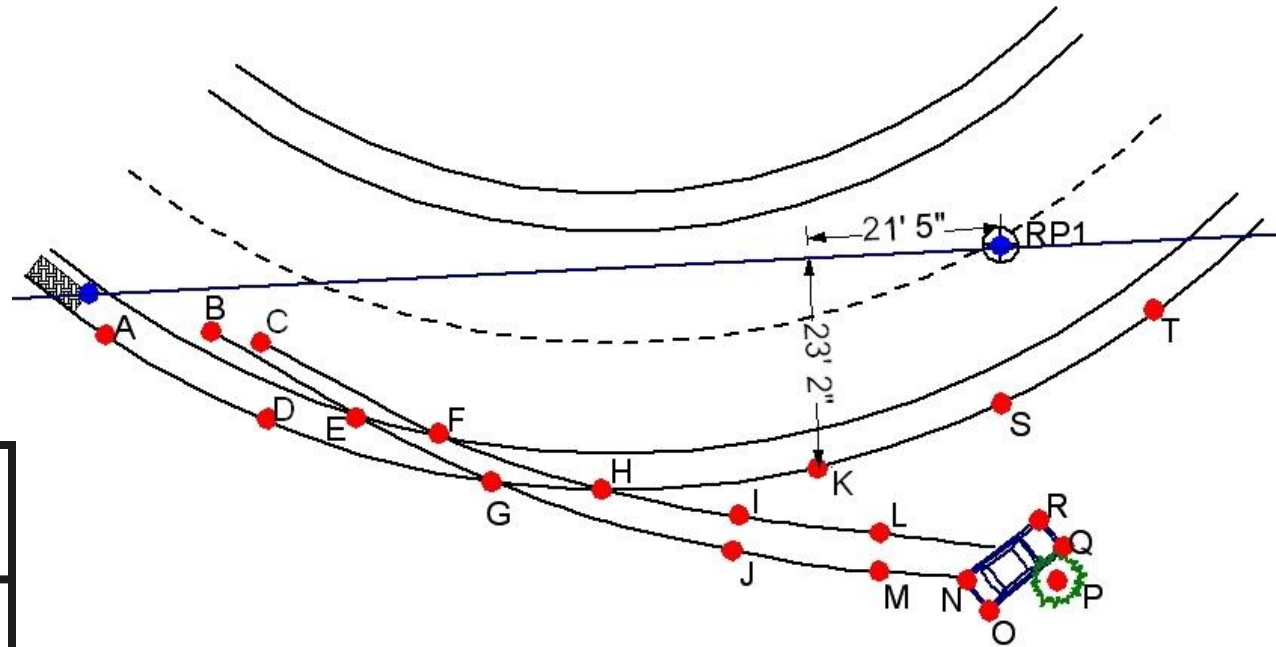

Letter	Location	RP	Edge
Road Edge	K	$21 \frac{5}{W}$	$23 \frac{2}{S}$

You can also **create a reference line** between the 2 reference points.

Blood Draw Consent Form.pdf

Salt Lake City Police Department

Consent to Search Form

SLCPD Case # _____

Date _____

Location _____

I, _____, residing at
_____, _____, Utah,
hereby voluntarily give consent to law enforcement officers of the Salt Lake
City Police Department to conduct a search of my blood by submitting to a
blood draw administered by a SLCPD Blood Draw technician.

I understand that the law enforcement officers do not now have a search warrant
and that I have a constitutional right to refuse to consent to such a search.

My signature below acknowledges that I have read and understand this
document and I have no questions regarding its content.

**My signature is free and voluntary and this written permission is being
given by me without threats or promises of any kind.**

Signed: _____ **Dated:** _____

Witness: _____ **Dated:** _____

Witness: _____ **Dated:** _____

Firearms Safe Harbor Declaration.pdf

**DECLARATION OF OWNER-COHABITANT
AND
REQUEST FOR FIREARM SAFEKEEPING UNDER UTAH CODE § 53-5c-201**

Owner-Cohabitant Name: _____

Owner-Cohabitant Address: _____

Owner-Cohabitant Telephone Number: _____

Firearm Serial Number: _____

Date Firearm Accepted for Safekeeping: _____

Declaration

I, _____, declare and state as follows:
(name of owner-cohabitant)

1. I am 21 years of age or older.
2. I am a cohabitant with someone who is an immediate threat to (circle all that apply): (a) himself or herself; (b) me; or (c) another person.
3. I have an ownership interest, in whole or in part, in the firearm(s) with serial number(s) _____.
(serial number(s))
4. As an owner-cohabitant, I am voluntarily committing the firearm(s) listed above to the Salt Lake City Police Department for safekeeping for 60 days under Utah Code § 53-5c-201.

I DECLARE UNDER CRIMINAL PENALTY OF THE STATE OF UTAH THAT THE FOREGOING IS TRUE AND CORRECT.

DATED this _____ day of _____, 20_____.

(signature of owner-cohabitant)

WITNESSED:

(officer name and signature)

Accident Flow Chart.pdf

Fatal & Probable Fatal Crashes

Watch Commander/Sergeant Notified

- ✓ Respond to the Scene
- ✓ Initiate Initial Investigation (DI-9)
- ✓ Start Scene Security & Major Incident Log
- ✓ Crime Lab Photographs
- ✓ Witnesses IDed & Retained (Statements Completed)
- ✓ Officers on-scene Check Sobriety
- ✓ Condition Verified

Verified Alpha, Bravo, OR Charlie

Verified Delta OR Echo (in-person @ Hospital)

*On A & B injuries photos can be taken by Officer with an adequate phone camera

Call for Barricades

Initial Officer Completes DI-9

Call the Property Crimes Lieutenant OR Unified Dispatch (801-743-3000) for "CAR" Response (NOT CART)

Patrol Diagrams Scene (on Charlie condition accidents)

DI-9 Completed by Initial Officer
CAR assumes Investigation

Hospitals DO NOT USE alphanumeric codes

Critical Unstable IS considered Delta

Conscious, Breathing, & Alert is NOT considered Delta by PD

Officer Involved Crash

Level 2 Crash

A level 2 collision occurs when a Department employee operating a vehicle owned or leased by the City collides with a fixed object or other City-owned/leased vehicle or property resulting in minor (non-reportable) damage to only the City-owned/leased vehicle or property.

Collision Occurs

Watch Commander/Sergeant Notified

Involved Officer Completes Employee Accident Report Form

Photos Taken of Damage (This can be done with an adequate phone camera)

- ✓ Directly entered into Blue Team (within 12 hours of occurrence) by handling Supervisor within same Division
- ✓ Photos & Employee Accident Report Form attached to Blue Team
 - DI-9 is NOT necessary
- ❖ A G.O. Report is ONLY necessary IF Crime Lab is called for photos

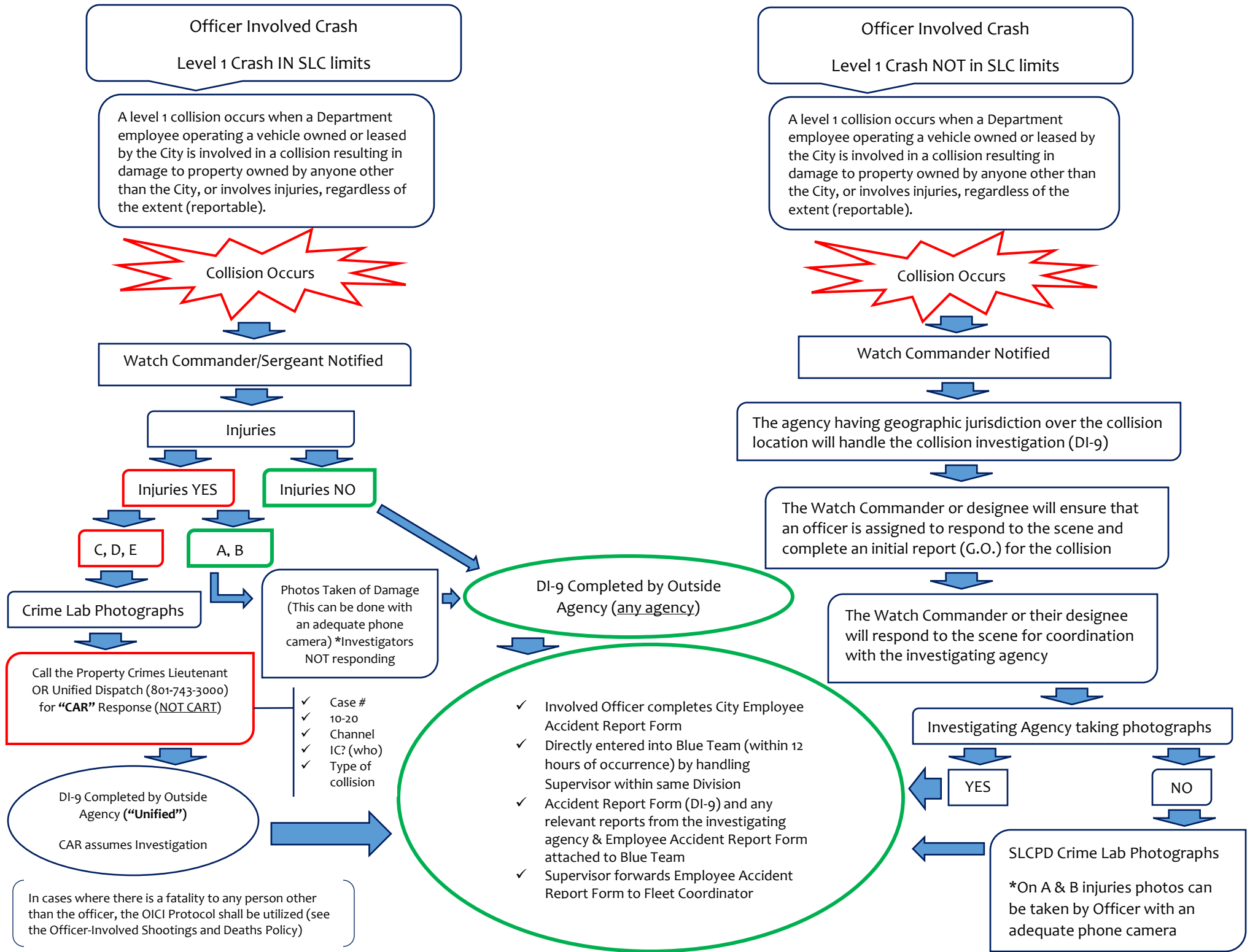

Officer Involved Crash

Level 1 Crash IN SLC limits

A level 1 collision occurs when a Department employee operating a vehicle owned or leased by the City is involved in a collision resulting in damage to property owned by anyone other than the City, or involves injuries, regardless of the extent (reportable).

Collision Occurs

Watch Commander/Sergeant Notified

Injuries

Injuries YES

Injuries NO

C, D, E

A, B

Crime Lab Photographs

Call the Property Crimes Lieutenant OR Unified Dispatch (801-743-3000) for "CAR" Response (NOT CART)

DI-9 Completed by Outside Agency ("Unified")
CAR assumes Investigation

In cases where there is a fatality to any person other than the officer, the OICI Protocol shall be utilized (see the Officer-Involved Shootings and Deaths Policy)

- ✓ Case #
- ✓ 10-20
- ✓ Channel
- ✓ IC? (who)
- ✓ Type of collision

Photos Taken of Damage (This can be done with an adequate phone camera) *Investigators NOT responding

DI-9 Completed by Outside Agency (any agency)

- ✓ Involved Officer completes City Employee Accident Report Form
- ✓ Directly entered into Blue Team (within 12 hours of occurrence) by handling Supervisor within same Division
- ✓ Accident Report Form (DI-9) and any relevant reports from the investigating agency & Employee Accident Report Form attached to Blue Team
- ✓ Supervisor forwards Employee Accident Report Form to Fleet Coordinator

Officer Involved Crash

Level 1 Crash NOT in SLC limits

A level 1 collision occurs when a Department employee operating a vehicle owned or leased by the City is involved in a collision resulting in damage to property owned by anyone other than the City, or involves injuries, regardless of the extent (reportable).

Collision Occurs

Watch Commander Notified

The agency having geographic jurisdiction over the collision location will handle the collision investigation (DI-9)

The Watch Commander or designee will ensure that an officer is assigned to respond to the scene and complete an initial report (G.O.) for the collision

The Watch Commander or their designee will respond to the scene for coordination with the investigating agency

Investigating Agency taking photographs

YES

NO

SLCPD Crime Lab Photographs

*On A & B injuries photos can be taken by Officer with an adequate phone camera

Property Release Form.pdf



SALT LAKE CITY POLICE DEPARTMENT PROPERTY RELEASE FORM



Case # _____

Date _____

RELEASES

Items to be released: _____

Authorized release to: _____

Authorized by: _____ ID _____

Will retain in case file.

Will be returning.

Signature: X _____

Address: _____

Phone #: _____

ID Used: _____ ID#: _____

Domestic Violence Flow Chart.pdf

Domestic Violence Basic Flow Chart

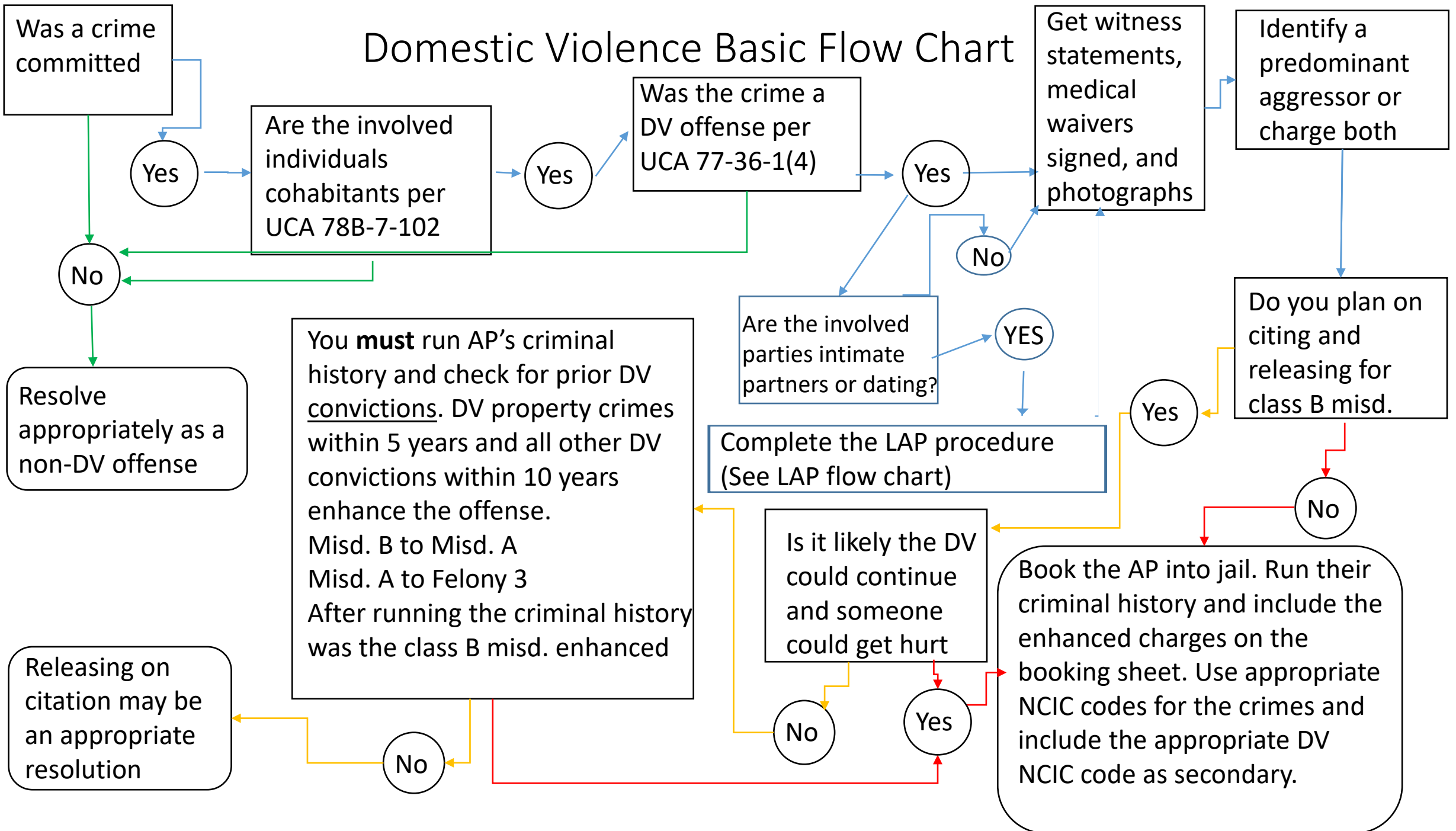

You **must** run AP's criminal history and check for prior DV convictions. DV property crimes within 5 years and all other DV convictions within 10 years enhance the offense.
 Misd. B to Misd. A
 Misd. A to Felony 3
 After running the criminal history was the class B misd. enhanced

Book the AP into jail. Run their criminal history and include the enhanced charges on the booking sheet. Use appropriate NCIC codes for the crimes and include the appropriate DV NCIC code as secondary.

INDEX / TOPICS